

All Products Guide

Vol.8



Main Products Line up

Oscilloscopes



Mixed Signal Oscilloscopes
DLM3000 Series

new

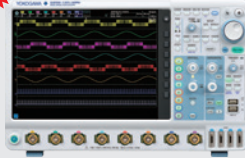

Mixed Signal Oscilloscopes
DLM5000 Series



Portable ScopeCorder DL350

new



ScopeCorder DL950



High-Speed Data Acquisition Unit SL1000

Digital Power Analyzers



Precision Power Analyzer WT5000



Precision Power Scope PX8000



Precision Power Analyzer WT1800E



Power Analyzer WT500



Digital Power Meters WT300E Series

Optical Measuring Instruments

new

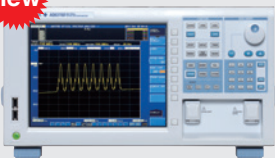

Optical Spectrum Analyzer
AQ6370 Series

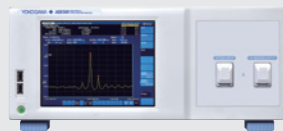

Optical Spectrum Analyzer
AQ6360



Optical Wavelength Meter
AQ6150 Series



Multi Application Test System
AQ2200 Series



Optical Time Domain
Reflectometer
AQ7280 Series

new



Multi Field Tester OTDR
AQ1210 Series



Entry Level OTDR
AQ1000



1G/10G Ethernet Tester
AQ1300 Series



Handy size
Optical Power Meter
AQ2170
Series



Handy size
Optical Power Meter
AQ2180
Series



Handy size
Light Source
AQ4280
Series

Generators, Sources, Manometers etc.



AC Power Calibrator
LS3300



DC Voltage/Current Source
GS200



Precision DC Calibrator
2560A



Digital Manometer
MT300



new

Calibrators



CA700



PM100



CA310



CA320



CA330



CA500



CA71



CA450

Digital Multimeters



TY700 Series



TY500 Series

Insulation Tester



MY600

Earth Tester



EY200

Clamp-on Testers



CL150/155



CL220



300 Series



CL420

Thermometers



TX10 Series

Clamp-on Power Meters



CW500

Precision Measuring Instruments



279301

Contents

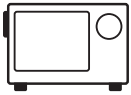

[Oscilloscopes]

P. 6 to P. 25

ScopeCorder and High-Speed Data Acquisition Unit.....	6	Waveform Measuring (Digital and Mixed Signal Oscilloscopes).....	18, 19
ScopeCorder (DL950)	8, 9	Mixed Signal Oscilloscope (DLM3000 Series).....	20, 21
ScopeCorder (DL350)	10, 11	Mixed Signal Oscilloscopes (DLM5000) ...	22, 23
High-Speed Data Acquisition Unit (SL1000).....	12	Waveform Measuring (Oscilloscopes Accessories)	24
High-Speed Data Acquisition Unit (SL1000 Acquisition Software)	13	Oscilloscope Application Software (701992 Xviewer) (XviewerLITE)	25
Waveform Measuring (ScopeCorder Accessories)	14		
Module and accessory combinations	15		



[Digital Power Analyzers]

P. 26 to P. 39

Digital Power Analyzers Selection Guide	26	Current Sensor Unit (751522/751524).....	36
Power Analyzer (WT500).....	27	WT Series Accessory Software (761941 WTViewerE Application Software) ...	37
Precision Power Analyzer (WT5000)	28, 29	WT Series Accessory Software (Power Consumption Measurement Software) ...	37
High Performance Power Analyzer (WT1800E).....	30, 31	WT Series Accessory Software (761922 IEC regulation software).....	38
Digital Power Meters (WT300E Series) ...	32, 33	Digital Power Analyzers Accessories List (Accessories List).....	39
Precision Power Scope (PX8000).....	34, 35		
AC/DC Current Sensor (CT60/CT200/CT1000/CT2000A)	36		
Current Probe (751552)	36		



[Integrated Software Platform]

P. 40 to P. 41

Integrated Software Platform (IS8000 Series).....	40
---	----



[Generators, Sources, Manometers etc.]

P. 42 to P. 54

DC Voltage/Current Source (GS200).....	42	AC Voltage Current Standard (2558A).....	50
Multi Channel Source Measure Unit (GS820)...	43	Digital Multimeter (DM7560).....	51
Source Measure Unit (GS610).....	44	Arbitrary/Function Generator (FG400 Series).....	52
GS Series Accessory Software (765670 Curve Tracer Software for the GS Series)	45	Pneumatic Pressure Standard (MC100)	53
AC Power Calibrator (LS3300).....	46	Digital Manometer (MT300).....	54
Precision DC Calibrator (2560A).....	47		
Power Meter Calibration Software (Free Software).....	48		
Precision DC Calibrator (2553A).....	49		



[Optical Measuring Instruments]

P. 55 to P. 69

Optical Spectrum Analyzer (AQ6370 Series) ...	55	Optical Time Domain Reflectometer (AQ7280 Series)	64
Optical communication model (AQ6370D)...	56	MFT-OTDR (AQ1210 Series).....	65
Short wavelength model (AQ6373B).....	57	Entry Level OTDR (AQ1000)	66
Wide range model (AQ6374).....	58	Optical Power Meter (AQ2170 Series)	67
Long wavelength model (AQ6375B/AQ6376)...	59	Optical Power Meter (AQ2180 Series)	67
Long wavelength model (AQ6377).....	60	Optical Light Source (AQ4280 Series)	67
Optical Spectrum Analyzer (AQ6360)	61	MFT-OLTS (AQ1100 Series).....	68
Optical Wavelength Meter (AQ6150 Series)	62	MFT-1/10GbE (AQ1300 Series).....	69
Multi Application Test System (AQ2200 Series)	63		



[Calibrators]

P. 70 to P. 77

CA700, 91050/91055/91060, PM100, CA500, CA550, CA71, CA300 Series, CA450



[Clamp-on Power Meters]

P. 78 to P. 79

CW500, CW10



[Digital Multimeters]

P. 80 to P. 83

TY700 Series, TY500 Series, 92015, DMM Accessories



[Clamp-on Testers]

P. 84 to P. 85

CL100 Series, CL200 Series, 30031A/30032A, CL300 Series, CL420



[Insulation Tester]

P. 86

MY600

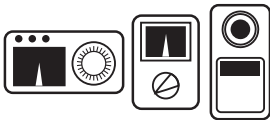

[Earth Tester]

P. 87

EY200



[Thermometers]

P. 88

TX10 Series



[Precision Measuring Instruments]

P. 89

2792A Series, 278610/278620, 279301/279303

Oscilloscopes

Digital Power Analyzers

Integrated Software Platform

Generators, Sources, Manometers etc.

Optical Measuring Instruments

Calibrators

Clamp-on Power Meters

Digital Multimeters

Clamp-on Testers

Insulation Tester

Earth Tester

Thermometers

Precision Measuring Instruments





Products with this mark conform to the EMC standards (regulations on electromagnetic interference) of European Community.

Waveform Measuring ScopeCorder and High-Speed Data Acquisition Unit

They can be used to capture single-shot or infrequently recurring signals.

They can also execute computations on repetitive waveforms, and automatically extract waveform parameters.

Selection Guide*1

Model	DL950	DL350	SL1000				
Item	 ...P.8	 ...P.10	 ...P.12				
Features	<ul style="list-style-type: none"> Powerful mobile data acquisition recorders Measure & analyze dynamic behavior of electromechanical systems Flexible modular inputs for voltage, current, sensors, CAN/CAN FD/LIN bus and SENT. Trend & Trigger on electrical power calculations (optional) GPS/IRIG capability (optional) 	<ul style="list-style-type: none"> A4-sized compact chassis AC/DC/Battery operated Up to 50 days continuous recording onto SD card Vibration-resistant design Intuitive operation using 8.4-inch touch screen Flexible modular inputs for voltage, current, sensors, CAN/CAN FD/LIN bus and SENT. GPS capability⁵ 	<ul style="list-style-type: none"> Fast Acquisition, Transfer, and Storage High-Performance Data Acquisition Unit Easy to use Easy to use Standard Acquisition Software Max. 128 ch Synchronized (16 ch × 8 units) Data files recorded by multiple units, in synchronized mode, are all linked together by a common LINK file, thereby facilitating batch processing. 				
Max. sampling rate	200 MS/s ²	100 MS/s ²	100 MS/s ²				
Bandwidth	40 MHz ²	20 MHz ²	20 MHz ²				
Number of analog input channels	32 ch max. (when using eight 720256 modules)	32 ch max. (when using two 720220 modules)	16 ch max. (when using any 2 ch input module.) 128 ch max. synchronized (16 ch × 8 units)				
Logic input	128 bits max. (when using eight 720230 modules)	48 bits max. (when using two 720230 modules and logic input terminals)	—				
Max. vertical sensitivity (1:1)	100 μV/div ²	100 μV/div ²	100 μV/div ²				
Vertical axis resolution	16 bit ²	16 bit ²	16 bit ²				
Max. sweep sensitivity	100 ns/div ²	1 μs/div ²	15 ns/div (Zoom display)				
Max. record length	<table border="1" style="width: 100%; border-collapse: collapse;"> <tr> <td style="text-align: center;">Standard</td> <td>500 Mpts (MW) /50 Mpts (MW) (16ch)</td> </tr> <tr> <td style="text-align: center;">Optional</td> <td>4 Gpts (GW) /500 Mpts (MW) (16ch)</td> </tr> </table>	Standard	500 Mpts (MW) /50 Mpts (MW) (16ch)	Optional	4 Gpts (GW) /500 Mpts (MW) (16ch)	100 Mpts/module (Internal Memory) 20 Gpts/module (SD Card)	50 MW/ch (Single Trigger Mode)
Standard	500 Mpts (MW) /50 Mpts (MW) (16ch)						
Optional	4 Gpts (GW) /500 Mpts (MW) (16ch)						
Internal media drive	<table border="1" style="width: 100%; border-collapse: collapse;"> <tr> <td style="text-align: center;">Standard</td> <td>SD memory card slot</td> </tr> <tr> <td style="text-align: center;">Optional</td> <td>Internal SSD 512 GB</td> </tr> </table>	Standard	SD memory card slot	Optional	Internal SSD 512 GB	SD memory card slot	— Internal HDD 500 GB
Standard	SD memory card slot						
Optional	Internal SSD 512 GB						
Interface	<table border="1" style="width: 100%; border-collapse: collapse;"> <tr> <td style="text-align: center;">Standard</td> <td>USB3.0/Ethernet (1000BASE-T)</td> </tr> <tr> <td style="text-align: center;">Optional</td> <td>10 Gbps Ethernet</td> </tr> </table>	Standard	USB3.0/Ethernet (1000BASE-T)	Optional	10 Gbps Ethernet	USB2.0/Ethernet (100BASE-TX/10BASE-T)	USB2.0 Ethernet (1000BASE-T)
Standard	USB3.0/Ethernet (1000BASE-T)						
Optional	10 Gbps Ethernet						
Others	<table border="1" style="width: 100%; border-collapse: collapse;"> <tr> <td style="text-align: center;">Optional</td> <td> <ul style="list-style-type: none"> 21 types of plug-in modules IRIG interface GPS interface User-defined math function Real time math function Probe power (4-output or 8-output) Power math function </td> </tr> </table>	Optional	<ul style="list-style-type: none"> 21 types of plug-in modules IRIG interface GPS interface User-defined math function Real time math function Probe power (4-output or 8-output) Power math function 	<ul style="list-style-type: none"> 18 types of plug-in modules Vehicle Edition GPS unit (separately sold accessory) 	<ul style="list-style-type: none"> 13 types of plug-in modules Probe power (4-output) Without Xviewer With the Xviewer Math Edition (1 license) (701992-GP01) 		
Optional	<ul style="list-style-type: none"> 21 types of plug-in modules IRIG interface GPS interface User-defined math function Real time math function Probe power (4-output or 8-output) Power math function 						
Power supply	AC	Battery/AC (adopter)/DC (10 V to 30 V)	AC				
Display (TFT LCD)	12.1-inch color XGA (capacitive touch screen)	8.4-inch color SVGA (resistive touch screen)	—				
External dimensions W × H × D (mm)	375 × 259 × 202	305 × 217 × 92	319 × 154 × 350				
Weight (kg)	Approx. 7.5 ³	Approx. 3.9 ⁴	Approx. 6.0 ³				

*1: See each product catalog for more detailed specifications *2: Depends on input module *3: Plug-in modules are not included

*4: When the DL350 equipped with the battery and 2 pieces of 720254. *5: The GPS unit can only be supplied to countries where it is not prohibited by local radio laws.

Plug-in Module Selection Guide*1

Input	Model No.	Sample rate	Resolution	Bandwidth	Number of channels	Isolation	Maximum measurement voltage ¹¹ (DC + ACpeak)	DC accuracy	Note
Analog Voltage	720212 ^a	200 MS/s	14 bit	40 MHz	2	Isolated	1000 V ² , 200 V ⁵	±0.5%	High speed, high voltage, isolated
	720211 ^a	100 MS/s	12 bit	20 MHz	2	Isolated	1000 V ² , 200 V ⁵	±0.5%	High speed, high voltage, isolated
	720250	10 MS/s	12 bit	3 MHz	2	Isolated	800 V ² , 200 V ⁵	±0.5%	High noise immunity
	701251	1 MS/s	16 bit	300 kHz	2	Isolated	600 V ² , 140 V ⁵	±0.25%	High sensitivity range (1 mV/div), low noise (±100 µV/typ.), and high noise immunity
	720256	10 MS/s	16 bit	3 MHz	4	Isolated	600 V ² , 200 V ⁵	±0.25%	4 CH BNC input low noise, high noise immunity
	720254	1 MS/s	16 bit	300 kHz	4	Isolated	600 V ² , 200 V ⁵	±0.25%	4 CH BNC input low noise, high noise immunity
	701255	10 MS/s	12 bit	3 MHz	2	Non-Isolated	600 V ⁴ , 200 V ³	±0.5%	High speed, non-isolated
	720268	1 MS/s	16 bit	300 kHz	2	Isolated	1000 V ¹⁰	±0.25%	With AAF, RMS, and high noise immunity
	720220	200 kS/s	16 bit	5 kHz	16	Isolated (GND-terminal) non-isolated (CH-CH)	20 V ³	±0.3%	16 CH voltage measurement (Scan-type)
Analog Voltage & Temperature	701261	100 kS/s (Voltage), 500 S/s (Temperature)	16 bit (Voltage), 0.1°C (Temperature)	40 kHz (Voltage), 100 Hz (Temperature)	2	Isolated	42 V	±0.25% (Voltage)	Thermocouple (K, E, J, T, L, U, N, R, S, B, W, KP/AuFe)
	701262	100 kS/s (Voltage), 500 S/s (Temperature)	16 bit (Voltage), 0.1°C (Temperature)	40 kHz (Voltage), 100 Hz (Temperature)	2	Isolated	42 V	±0.25% (Voltage)	Thermocouple (K, E, J, T, L, U, N, R, S, B, W, KP/AuFe), with AAF
	701265	500 S/s (Voltage), 500 S/s (Temperature)	16 bit (Voltage), 0.1°C (Temperature)	100 Hz	2	Isolated	42 V	±0.08 (Voltage)	Thermocouple (K, E, J, T, L, U, N, R, S, B, W, KP/AuFe), high sensitivity range (0.1 mV/div)
	720266	125 S/s (Voltage), 125 S/s (Temperature)	16 bit (Voltage), 0.1°C (Temperature)	15 Hz	2	Isolated	42 V	±0.08 (Voltage)	Thermocouple (K, E, J, T, L, U, N, R, S, B, W, KP/AuFe), high sensitivity range (0.1 mV/div), Low noise
	720221 ^b	10 S/s	16 bit	600 Hz	16	Isolated	20 V	±0.15% (Voltage)	16 CH voltage or temperature measurement (scan method) Thermocouple (K, E, J, T, L, U, N, R, S, B, W, KP/AuFe)
Strain	701270	100 kS/s	16 bit	20 kHz	2	Isolated	10 V	±0.5% (Strain)	Supports strain NDIS, 2, 5, 10 V built-in bridge power supply
	701271	100 kS/s	16 bit	20 kHz	2	Isolated	10 V	±0.5% (Strain)	Supports strain DSUB, 2, 5, 10 V built-in bridge power supply, and shunt CAL
Analog Voltage, Acceleration	701275	100 kS/s	16 bit	40 kHz	2	Isolated	42 V	±0.25% (Voltage) ±0.5% (Acceleration)	Built-in anti-aliasing filter, Supports built-in amp type acceleration sensors (4 mA/22 V)
Frequency	720281	1 MS/s	16 bit	resolution 625 ps	2	Isolated	420 V ² , 42 V ³	±0.1% (Frequency)	Measurement frequency of 0.01 Hz to 500 kHz, Measured parameters (frequency, RPMs, RPSs, period, duty cycle, power supply frequency, pulse width, pulse integration, and velocity)
Logic	720230	10 MS/s	—	—	8 bit × 2 ports	non-isolated	depend on logic probe used.	—	(8 bit/port) × 2, compatible with four types of logic probe (sold separately)
CAN/CAN FD	720242	100 kS/s	—	—	(60 signals × 2) port	Isolated	10 V	—	CAN/CAN FD port × 2, extraction of up to 32-bit data ^{6,7}
CAN, LIN	720241	100 kS/s	—	—	(60 signals × 2) port	Isolated	10 V (CAN port) 18 V (LIN port)	—	CAN port × 1 (CAN FD is not supported), LIN port × 1 ^{6,7}
SENT	720243	100 kS/s	—	—	11 data × 2 ports	Isolated	42 V	—	Supported protocol: SAE J2716. ^{6,7}

*1: Probes are not included with any modules. *2: In combination with 700929, 702902, or 701947 probe. *3: Direct input *4: In combination with 10:1 probe model 701940 *5: In combination with 701901 & 701954. *6: Any other modules can be installed in the remaining slots. *7: When using these modules with DL950/VCE or DL850EV, up to four, CAN & LIN Bus Monitor Modules (720241), CAN/CAN FD Monitor Modules (720242) or SENT Monitor Modules (720243) total can be used on a single main unit. For the CAN & LIN Bus Monitor Modules (720241), CAN/CAN FD monitor modules (720242), up to two in total can be used on a single main unit. *8: The 16 CH Scanner Box (701953) is required for measurement. *9: Class 1 Laser Product, IEC/EN60825-1, GB7247.1-2012 *10: In combination with 758933 and 701954. 1000 Vrms (1000 VDC or 1414 Vpeak maximum) when using with DL950 or DL350. 850V (DC + ACpeak) when using with DL850/DL850V/DL850E/DL850EV or SL1000. *11: See the main specifications for voltage-axis sensitivity setting and measurement range.

Compatibility of the plug-in modules with the main units

Model	Plug-in Module Name	Remark	Main Unit				
			DL950	DL350	DL850E	DL850EV	SL1000
720212	High-speed 200 MS/s 14 Bit Isolation Module		Yes	No	No	No	No
720210	High-speed 100 MS/s 12 Bit Isolation Module	Discontinued	No	No	Yes	Yes	Yes
720211	High-speed 100 MS/s 12 Bit Isolation Module		Yes	Yes	Yes	Yes	Yes
701250	High-speed 10 MS/s 12 Bit Isolation Module	Discontinued	Yes	No	Yes	Yes	Yes
720250	High-speed 10 MS/s 12 Bit Isolation Module		Yes	Yes	Yes	Yes	Yes
701251	High-speed 1 MS/s 16 Bit Isolation Module		Yes	No	Yes	Yes	Yes
720256	4 CH 10 MS/s 16 Bit Isolation Module		Yes	No	No	No	No
720254	4 CH 1 MS/s 16 Bit Isolation Module		Yes	Yes	Yes	Yes	No
701255	High-speed 10 MS/s 12 Bit Non-Isolation Module		Yes	No	Yes	Yes	Yes
701267	High-voltage 100 kS/s 16 Bit Isolation Module (with RMS)	Discontinued	No	No	Yes	Yes	Yes
720268	High-voltage 1 MS/s 16 Bit Isolation Module (with AAF, RMS)		Yes	Yes	Yes	Yes	Yes
720220	16 CH Voltage Input Module		No	Yes	Yes	Yes	No
701261	Universal Module		Yes	Yes	Yes	Yes	Yes
701262	Universal Module (with AAF)		Yes	Yes	Yes	Yes	Yes
701265	Temperature/High-Precision Voltage Module		Yes	Yes	Yes	Yes	Yes
720266	Temperature/High-Precision Voltage Isolation Module (Low Noise)		Yes	Yes	Yes	Yes	Yes
720221	16 CH Temperature/Voltage Input Module		Yes	Yes	Yes	Yes	No
701270	Strain Module (NDIS)		Yes	Yes	Yes	Yes	Yes
701271	Strain Module (DSUB, Shunt-CAL)		Yes	Yes	Yes	Yes	Yes
701275	Acceleration/Voltage Module (with AAF)		Yes	Yes	Yes	Yes	Yes
701281	Frequency Module	Discontinued	Yes	No	Yes	Yes	Yes
720281	Frequency Module		Yes	Yes	Yes	Yes	Yes
720230	Logic Input Module		Yes	Yes	Yes	Yes	No
720240	CAN Bus Monitor Module	Discontinued	Yes	Yes	No	Yes	No
720242	CAN/CAN FD Monitor Module		Yes	Yes	No	Yes	No
720241	CAN & LIN Bus Monitor Module		Yes	Yes	No	Yes	No
720243	SENT Monitor Module		Yes	Yes	No	Yes	No

Note: • Probes are not included with any modules.
• The use of a 720221 module requires an External Scanner Box (model 701953).
• Firmware update may be required depending on the module used.

• The /VE option is required when using a 720240, 720241, 720242, or 720243 module with a DL350.
• The /VCE option is required when using a 720240, 720241, 720242, or 720243 module with a DL950.
• Refer to the note on page 20 when using a 720254 module with a DL850E or DL850EV.

ScopeCorder DL950

Powerful data acquisition enables the research of dynamic behavior within your application



Basic Specifications

Max. sampling rate	200 MS/s (720212) ^{*1}
Frequency bandwidth	40 MHz (720212) ^{*1}
Number of channels	Max. 128 ch, Number of slots for the plug-in module: 8
Logic input	Max. 128 bits (When using eight 720230 modules)
A/D conversion resolution	16, 14 or 12 bits ^{*1}
DC accuracy	±(0.5% of 10 div) (720250 and 701255) ^{*1}
Time axis setting	100 ns/div to 20 day/div
Time axis accuracy	±4.6 ppm
Max. record length	Standard: 500 Mpts (MW)/CH /M2 option: 4 Gpts (GW)/CH
Channel-to-channel calculation function	Definable math waveforms 8
Automatic measurement of waveform parameters	Maximum number of displayed parameters 80
Cycle statistical/historic process	Product of number of cycles and parameters 64000
Internal media drive	SD memory card slot (standard) 512 GB internal SSD (option)
Communication interface (standard)	USB 3.0 (standard)/Ethernet 1000BASE-T 10 Gbps Ethernet (option)
Other options	IRIG interface GPS interface User defined computation Real time math computation Power math computation Four/eight probe power outputs
Display	12.1 inch TFT color LCD monitor
Display resolution	1024 × 768 pixels (XGA)
External dimensions	375 (W) × 259 (H) × 202 (D) mm (excluding handle and protrusions)
Weight	Approx. 7.5 kg to 10 kg (varies depending on the types and the number of modules used)

*1: Varies depending on the module.

Overview

A ScopeCorder is a powerful portable data acquisition recorder that can capture and analyze both transient events and trends for long time. Using flexible modular inputs it combines the measurements of electrical and physical (sensor) signals, such as from CAN/CAN FD, LIN, SENT and is also able to trigger on electrical power related calculations in real-time.

Flexible Inputs with Built-in Signal Conditioning

Choose from up to 21 input modules and gain a thorough insight into any application by synchronizing the measurement of multiple parameters.

- Voltage and Current
- Sensor Outputs
- Temperature, Vibration /Acceleration, Strain, Frequency
- Logic Signals & CAN/ CAN FD/LIN and SENT

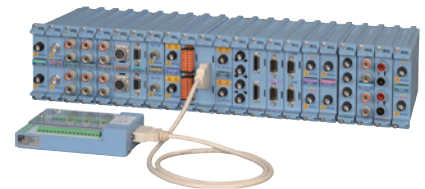

Large (8 Gpoint) memory offers long duration measurement and two instantaneous zoom locations – 8 GPoint memory (/M2 option*) –

Comes standard with 1 Gpoints of memory, expandable with 4 or 8 GPoint options.

Large capacity memory does not only simply provide longer durations of measurement, but also higher sampling rate at the same measurement time or multi-channel at the same sampling rate.

*Memory allocated to 1-CH is up to 4 G points.

10 GE data transfer (/C60 option)

Using 10 Gbps Ethernet, up to 10 MS/s of data can be stored in real time on a PC. An SFP+ module, a fiber optic cord, and the PC software IS8000 are used for data transfer.

*Please use a commercially available SFP+ module and a 10 GE fiber optic cord.

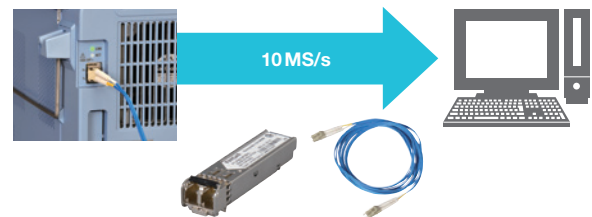

SSD recording and Flash Acquisition*

In addition to SSD recording, which provides recording to 512 GB internal SSD with up to 2 MS/s, Flash Acquisition provide long time recording to internal Flash memory with up to 20 MS/s.

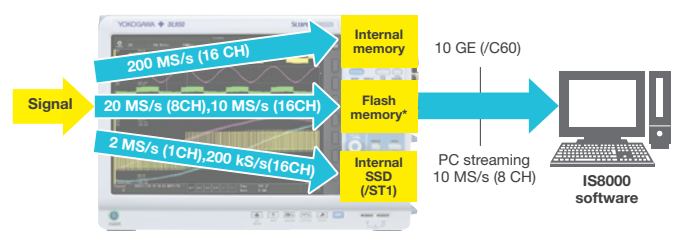

*Recording to flash memory will be coming soon.

Multi-unit synchronization of up to 160-CH (/C50 option)

The number of channels can be extended up to 160 by connecting up to 4 sub units to a single main unit with optical fiber cords. You can synchronize measurement start/stop of the sub units from the main unit.

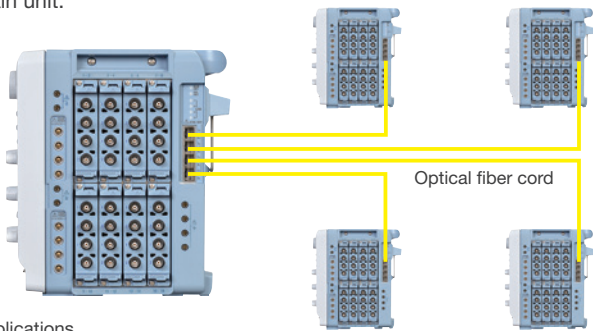

Applications

- Battery cell evaluation
 - Multi-point vibration analysis
 - Multi-point strain test
- *Please use the Optical Transceiver Module 720941 and the Optical Fiber Cord 720942.

Time synchronization IEEE1588/IRIG and GPS

Time synchronization with IEEE1588 signals is available. With the /C40 option, the DL950 can output IEEE1588 master signals. Time synchronization using IRIG and GPS is also available (/35 option).

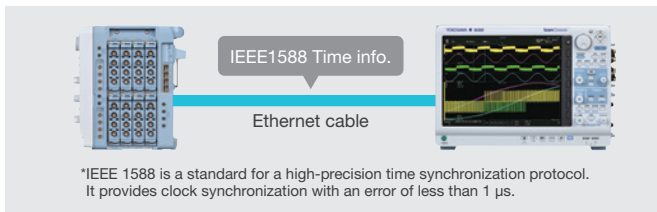

Easy access to frequently used applications

Touch an application icon, then the graphical setup screen for the application appears. You can register your frequently used applications as your favorite.



Power and harmonics analysis (/G05 option)

Evaluation of a system in which motors are driven by batteries, such as an EV, can be completed by a single DL950 unit. It calculates the conversion efficiency from the input and output power of the inverter and analyzes the effects of harmonics caused by external disturbances while capturing mechanical variations in motor speed and torque.

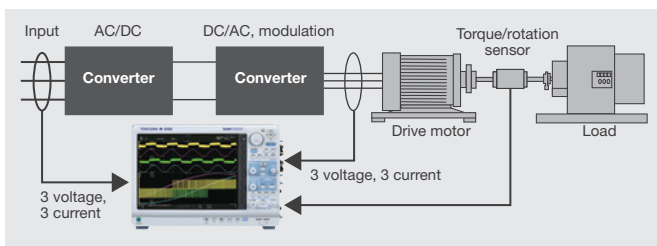

In-vehicle data measurement solution

The DL950 /VCE option provides enhanced features and functions mainly for vehicle development and evaluation. Supporting CAN/ CAN FD Monitor Module (720242), CAN & LIN Bus Monitor Module (720241) and SENT Monitor Module (720243), the DL950 can display each protocol communication data of in-vehicle networks as trend waveforms on the monitor. Also, it can trigger on decoded waveforms.

Comparative verification between measured signals and CAN and CAN FD bus signals

The CAN/CAN FD bus data and related waveforms can be viewed on the same screen. For example, you can check an ignition switch ON/OFF signal, a CAN FD signal corresponding to that command, and pressure signals on the same screen to verify the correlation between them.

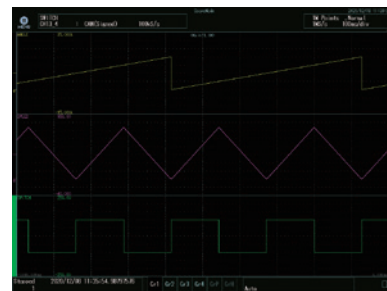

Model and suffix code

Model	Suffix codes	Description
DL950		ScopeCorder, 1 G Points memory ¹
Power cord	-D	UL/CSA standard and PSE compliant
	-F	VDE/Korean standard
	-R	Australian standard
	-Q	British standard
	-H	Chinese standard
	-N	Brazilian standard
	-T	Taiwanese standard
	-B	Indian standard
	-U	IEC Plug Type B
	Language	-HJ
-HE		English menu and panel
-HC		Chinese menu and panel
-HK		Korean menu and panel
-HG		German menu and panel
-HF		French menu and panel
-HL		Italian menu and panel
-HS		Spanish menu and panel
-HR		Russian menu and panel
Option		/M1 ²
	/M2 ²	Memory expansion to 8 G Points ⁷
	/ST1	Internal storage (512 GB)
	/C35	IRIG and GPS interface
	/C40	IEEE1588 Master function
	/C50	Multi-unit synchronization interface
	/C60	10 Gbps Ethernet interface
	/G02	User-defined math function
	/G03 ³	Real time math function
	/G05 ³	Power math function (including Real time math function)
/P4 ⁴	Four probe power outputs	
/P8 ⁴	Eight probe power outputs	
/VCE	Vehicle edition	

Standard Main Unit Accessories

Power cord, front cover, panel sheet, 8 slot cover panels, user's manuals⁵

¹: The main unit requires plug-in module (s). Max. 500 M Points/CH. ²,³,⁴: Only one of these can be selected. ⁵: The Start Guide is provided as a printed document and other manuals on a CD-ROM. ⁶: Max. 2 G Points/CH ⁷: Max. 4 G Points/CH

Additional option license for DL950*

Model	Suffix code	Description
709831	-C40	IEEE1588 Master function
	-G02	User-defined math function
	-G05	Power math function (including Real time math function) /G03 is necessary to add /G05
	-VCE	Vehicle edition

*Separately sold license product (customer-installable).

ScopeCorder **DL350**

The most comprehensive fully portable measuring instrument available for capturing, displaying, recording and analyzing

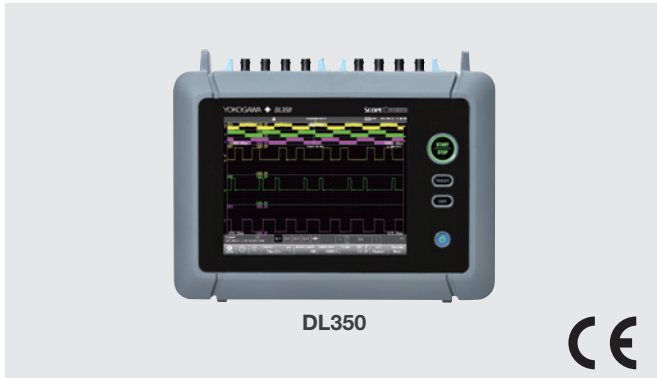

Basic Specifications

Sampling rate	up to 100 MS/s (720211) ^{*1}
Frequency bandwidth	up to 20 MHz (720211) ^{*1}
Number of channels	up to 8 ch (isolated), 32 ch (non-isolated) ^{*1}
Number of slots for the plug-in module	2
Built-in logic input	16 bits
A/D conversion resolution	16 or 12 bits ^{*1}
DC accuracy	±0.25% of 10 div. (720254) ±0.50% of 10 div. (720211) ^{*1}
Time axis accuracy	±0.001%
Record length	up to 100 Mpoint/module (For internal memory) up to 20 Gpoint/module (For SD memory card)
Analysis function	T-Y, X-Y, FFT and Harmonic analysis
Auxiliary I/O	External Clock Input, Trigger Input/Output, GO/NO-GO Output, External Start/Stop Input, Event Input, Probe-Compensation-Signal Output and GPS Input
Communication interfaces	USB 2.0 (standard) Ethernet 100 BASE-TX/10 BASE-T (standard)
Storage destination	SD memory card, USB storage
Display	8.4-inch color TFT LCD (resistive touch screen)
Display resolution	800 × 600 pixels (SVGA)
Operating temperature	0 to 45°C (with battery/DC power)
Power Supply	AC adapter (720921), DC power (720922) or battery pack (/EB option or 739883)
Battery pack operation time	Approx. 3 hours
External dimensions	Approx. 305 (W) × 217 (H) × 92 (D) mm (excluding handle and protrusions)
Weight	Approx. 3.9 kg (When the DL350 equipped with the battery and 2 pieces of 720254)
Major accessories	720902 10:1 Probe 701947 100:1 Probe 720930 Clamp-on probe (up to AC 50 A) 720931 Clamp-on probe (up to AC 200 A) 702912 Logic probe (TTL level/contact input/3 m) 93050 Carrying case 720940 GPS unit ^{*2}

*1: Varies depending on the module.

*2: The GPS unit can only be supplied to countries where it is not prohibited by local radio laws.

Overview

The DL350 ScopeCorder combines in one compact instrument all the measurement and recording capabilities you need when you are away from your office or lab. High-speed signals or long-term recording, 'quick and simple' or sophisticated operation, the DL350 provides the flexibility you need when you need it.

Complete self-contained signal conditioning

This extraordinary input capability is achieved by providing 2 slots, which can be populated with any of 18 different types of user swappable input modules. This means, for example, that user-swappable 4 isolated 16-bit voltage inputs can be measured at 1 MS/s, alongside 16 temperatures or 2 separate CAN or LIN buses each containing 30 signals. Swap a module and measure at 100 MS/s with 12 bits of resolution and 1 kV of isolation. Meanwhile there are 16 built-in logic inputs; swap in a digital input module to add even more. Make AC measurements like a DMM with an RMS module in real-time or use a math channel after the recording is finished.

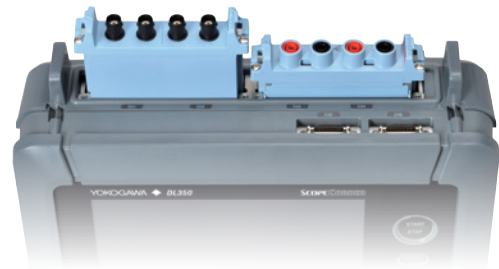

Intuitive operation

An 8.4 inch resistive touch screen has been adopted in order to deliver superior noise free performance. In environments with the highest levels of electrical noise such as motors and inverters, measurement precision is maintained whilst enabling the unit to be operated by using (gloved) fingers or stylus.



A wealth of triggers for fault finding

The user has a choice of a simple level trigger or can use enhanced triggers such things as pulse width, waveform period and across multiple channels. For example, the wave window trigger is ideal for AC power line monitoring which enables voltage sags, surges, spikes, phase shifts or drop outs to be easily captured (available for 40 to 1000 Hz waveforms).

Leave a DL350 unattended and automatically save the waveform to a file, or send a notification email, if and when it triggers.

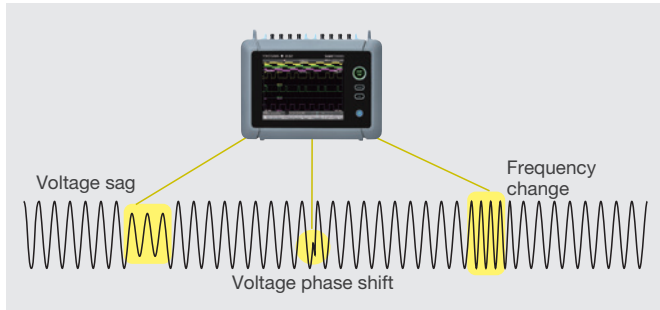

CAN/CAN FD bus, LIN bus and SENT monitoring

Use the DL350 with /VE option and bus monitor module to decode CAN/CAN FD bus, LIN bus or SENT signals and display information such as engine temperature, vehicle speed and brake pedal position as trend waveforms and compare this with the analog data coming from the actual sensors. This enables automotive engineers to gain an insight into the dynamic behavior of the complete electromechanical system.

Position and global timing using GPS

An optional GPS unit* enables latitude, longitude, altitude, speed and motion direction data to be synchronized with the waveform data, perfect for drive testing, mobile testing, or distributed field recordings.

*The GPS unit can only be supplied to countries where it is not prohibited by local radio laws.

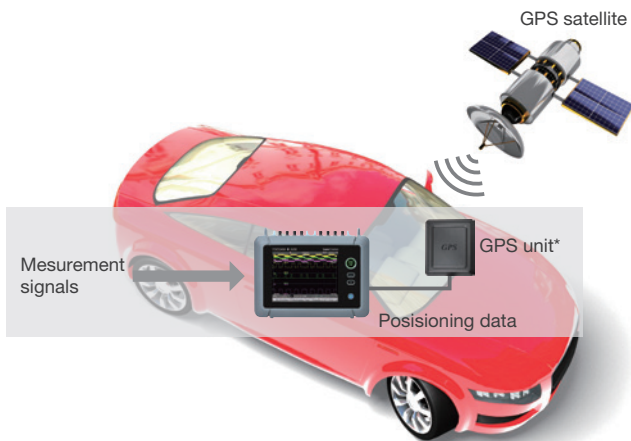

Mains, DC or rechargeable battery power

The built-in rechargeable battery provides 3 hours of continuous operation for mobile measurements or can serve as a backup power supply if the main DC power is disconnected. This makes the DL350 a highly reliable ScopeCorder for tests which are difficult or expensive to repeat.

Operates in freezing temperatures

Even when used with the rechargeable battery, the DL350 will operate in temperatures from 0 to 45 degrees. The DL350 brings high-quality laboratory measurements into the harsh environments of the field.



Assistant software (Free Software)

Data files or setup configuration files stored in the DL350 SD card can be backed up with the press of a button. Remote setting, start-stop control and setup file editing can also be easily done on the connected PC.

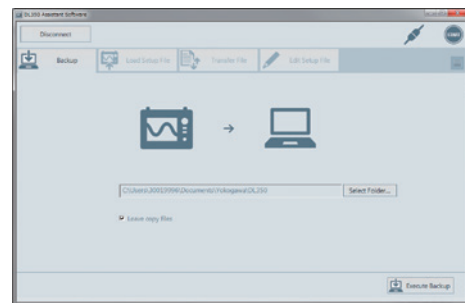

Model and suffix code

Model	Suffix Code	Description
DL350		DL350 ScopeCorder (Plug-in modules and AC adapter are not included.)
Languages	-HJ	Japanese menu
	-HE	English menu
	-HC	Chinese menu
	-HK	Korean menu
	-HG	German menu
	-HF	French menu
	-HL	Italian menu
	-HS	Spanish menu
	-HR	Russian menu
Options	/VE	Vehicle Edition
	/EB	Battery pack + Battery pack cover
720921		60 W AC Adapter AC adapter (Separate purchase) is required to charge the battery and operate the main unit.
Power cord	-D	UL/CSA Standard
	-F	VDE/Korean Standard
	-Q	BS/Singapore Standard
	-H	GB Standard
	-T	BSMI Certification
	-N	NBR Standard

Standard accessories: Hand strap, Slot cover panel (2), User's manual

DC power cable and Battery Pack Accessories

Model	Suffix Code	Description
720922		DC power cable (Cigarette lighter plug Type)
739883		Battery Pack ^{1,2,3}
720923		Battery Pack Cover ³

*1: AC adapter (720921) is required for charging battery.

*2: Operation of the battery pack (739883) requires the battery pack cover (720923)

*3: Included in the /EB option.

Additional Option License*1

Model	Suffix Code	Description
709830	-VE	Vehicle Edition

*1: Separately sold license product (customer-installable).

High-Speed Data Acquisition Unit **SL1000**

Fast Acquisition, Transfer, and Storage

High-Performance Data Acquisition Unit



Basic Specifications

Plug & Play	Auto-recognition of units and modules	
Input type	Plug-in module (A/D converters built in to each unit)	
Maximum number of input channels	16 (One unit operation) 128 (8 units synchronous operation)	
Maximum sample rate	100 MS/s on all channels	
Measuring mode	Free Run and Triggered	
Clock source	Internal and external	
Maximum record length (internal memory)	In Free Run mode	1 module: 32 MW/ch 2 modules: 16 MW/ch 3 to 4 modules: 8 MW/ch 5 to 8 modules: 4 MW/ch
	In Single Trigger mode	1 module: 50 MW/ch 2 modules: 25 MW/ch 3 to 4 modules: 10 MW/ch 5 to 8 modules: 5 MW/ch
Measuring groups	Up to 4 groups definable with independent sample rates	
Trigger mode	Normal, Single, and Single(N)	
Trigger source	Input channel, External, LINE, Time	
Record conditions	For Free Run mode	Immediate, abs. time, time divided, alarm, and external trigger
	For Trigger mode	Each trigger
Internal hard disk	500 GB (with the /HD1 option)	
Maximum real-time hard disk recording speed	Internal hard disk 1.6 MS/s (= 200 kS/s × 8 ch = 100 kS/s × 16 ch)	

Maximum measuring time (unit: seconds) at Single triggered measurement

	Sampling rate	Number of Measuring Channels			
		2 ch	4 ch	8 ch	16 ch
	100 MS/s	0.5	0.25	0.1	0.05
	50 MS/s	1	0.5	0.2	0.1
	10 MS/s	5	2.5	1	0.5
	1 MS/s	50	25	10	5
	500 kS/s	100	50	20	10
	200 kS/s	250	125	50	25
	1 kS/s	50000	25000	10000	5000

Features

Fast Acquisition

- Up to 100 MS/s on all channels (10 ns sampling interval)
- Supports parallel testing: Perform measurements with up to four simultaneously independent sample rates

Fast Transfer and Storage

- Stream data to PC via high speed USB 2.0 or 1000BASE-T Gigabit Ethernet
- Stream data to a PC hard disk or the SL1000's internal hard disk in real time (at speeds of 1.6 MS/s = 100 kS/s × 16 ch)^{*1}
- Maximum 8 synchronized units

^{*1}: Speed depends on PC performance and measuring conditions.

Easy to use

Easy to use Standard Acquisition Software

Max. 128 ch Synchronized (16 ch × 8 units)

Data files recorded by multiple units, in synchronized mode, are all linked together by a common LINK file, thereby facilitating batch processing. Using this LINK file, data from all units can be processed and analyzed, as one, at the same time.

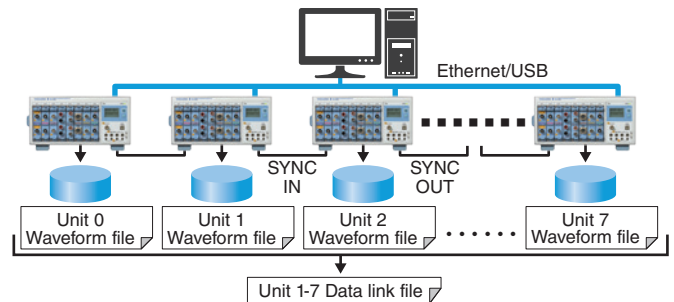

Stand-Alone Recording

Normally, SL1000 is controlled by PCs. However, SL1000 can record data even without PCs (/HD1 option is required). This stand-alone recording function is useful for the measurement in the severe environment.

Model and suffix code

Model	Suffix codes	Description
720120		SL1000 High-Speed Data Acquisition Unit ^{*1} Including Xviewer Standard Edition (1 license) (701992-SP01)
Power	-D	UL and CSA standard
Cord	-F	VDE standard
	-R	AS standard
	-Q	BS standard
	-H	GB standard (Complied with CCC)
Options	/HD1	Internal 500 GB HDD
	/C10	Ethernet Interface
	/P4	Probe power (4-output)
	/XV0	Without Xviewer
	/XV1	With the Xviewer Math Edition (1 license) (701992-GP01)

^{*1}: Plug-in modules and PC not included with the SL1000.

Model	Description
720211	High-speed 100 MS/s 12-Bit Isolation Module (2 ch)
720250	High-speed 10 MS/s 12-Bit Isolation Module (2 ch)
701251	High-speed 1 MS/s 16-Bit Isolation Module (2 ch)
701255	High-speed 10 MS/s 12-Bit non-Isolation Module (2 ch)
720268	High-voltage 100 kS/s 16-Bit Isolation Module (with AAF, RMS, 2 ch)
701261	Universal Module (2 ch)
701262	Universal Module (with Anti-Aliasing Filter, 2 ch)
701265	Temperature/High-precision voltage Module (2 ch)
720266	Temperature/High-precision voltage Module (2 ch)
701275	Acceleration/Voltage Module (with Anti-Aliasing Filter 2 ch)
701270	Strain Module (NDIS, 2 ch)
701271	Strain Module (DSUB, Shunt-CAL, 2 ch)
720281	Frequency Module

Model	Product	Description ^{*1}
720901-01	Synchronized connection cable	For SL1000 (1 m)
720901-02	Synchronized connection cable	For SL1000 (3 m)
751541-E4	Rack mounting kit	EIA standard
751541-J4	Rack mounting kit	JIS standard

High-Speed Data Acquisition Unit SL1000 Acquisition Software

Easy to Use

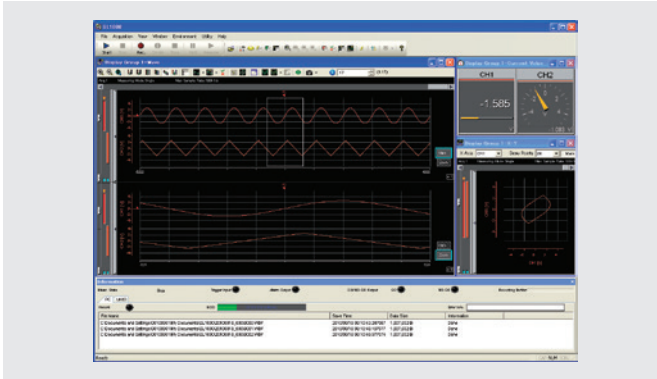

Main Specifications

Plug and Play	Auto-recognition of units and modules
Measurement modes	Free Run and Triggered
ACQ modes	Normal, envelope, and box average
Clock sources	Internal and external
Measurement groups	Up to 4 groups definable with independent sample rates
Trigger modes	Normal, single, and single(N)
Trigger sources	CH1-CH16, LINE, Time, and External
Other trigger functions	Combination trigger, hold-off, pretriggers, and trigger delay
Save conditions	Manual operation, or based on time, or alarms
Other save functions	Manual save (file division), specify no. of saves, save all data in memory, and save simultaneously to PC's hard disk and SL1000's internal hard disk (with /HD1 option)
Save format	Binary data file (original, *.wdf)
Waveform data conversion (Xviewer)	Binary data file(s) can be converted to ASCII (*.csv) or Excel (*.xls) format
Maximum speed for saving in real time	PC hard disk 1.6 MS/s (= 100 kS/s × 16 channels) ^{*1}
Waveform monitor	Trend display (displays measured waveforms of different sample rates simultaneously) ^{*2} , and instantaneous value displays (digital, bar graph, meter, and thermometer)
X-Y display	X-axis channel settings, selection of main or zoomed waveform (in Triggered mode), and selection of the number of data points to draw (2 K, 10 K, 100 K)
Mark display (Free run mode)	Setting of marks (up to 128 marks, each mark can display up to 16 characters), display color setting, mark editing, deletion of marks, mark list, collectively saving mark data with the same file name as the waveform data, and loading mark data into Xviewer.
Accumulation display	Accumulates T-Y and X-Y waveforms
Snapshot	Waveform that is currently being displayed can be retained on the screen as a snapshot waveform. Display color setting and snapshot waveform deletion
Display groups	Up to 4 display groups
Other display functions	History waveform, arbitrary axis divisions, and horizontal axis scaling + specifiable units (external clock)
Waveform analysis	Cursor and parameter measurement ^{*3}
Offline waveform computation (with /XV1 option)	Max. Number of displayed waveforms (CHs) 10 waveforms (Math1 to Math 10)
Operations	+, -, ×, /, trigonometry, differentiation/integration, FFT, and others
Alarms	Channel (alarm display and alarm history analysis) ^{*4} , system alarm, and alarm output
GO/NO-GO determination ^{*3}	Waveform parameter judgment and judgment output

System requirements

OS	Windows 7 (32 bit/64 bit)/Windows 8.1 (32 bit/64 bit)/Windows 10 (32 bit/64 bit)
CPU	Core 2 Duo 2 GHz or better
Memory	1 GB or more
Hard disk	500 MB or more of free space (40 GB or more when using the auto-save function)
Communication interfaces	USB 2.0/Ethernet 1000BASE-T (with /C10 option)
Display	XGA or better, Color: 65536 colors or better
Other	CD-ROM drive and mouse

*1: Typical values. Actual values depend on PC performance and measurement conditions.

*2: When the measurement mode is Free Run, the trigger mode is Single(N), and the number of measurements is Infinite, there may be a limit to the number of channels that can be trend-displayed during measurement. *3: Triggered measurement *4: Free Run measurement

Intuitive Operation

Setup Wizard Makes It Easy

The four screens of the Setup Wizard guide you easily through detailed settings for configuring the system, measuring, saving, and displaying. You can save and recall your settings at any time.

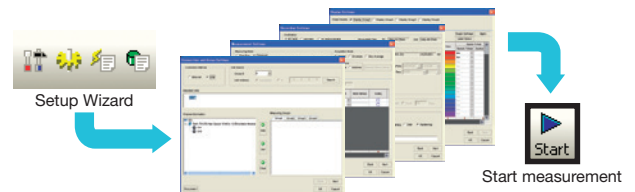

Control Buttons—Just Like Your DVD Remote

Measurement and saving can be started and stopped using the same familiar buttons found on a DVD remote control. Start using the instrument on the same day you receive it, with absolutely no programming required.

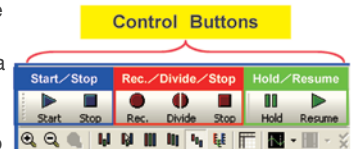

Displaying X-Y Waveforms

You can view both T-Y waveform display and X-Y waveform display. Using its fast update feature, you can evaluate data quickly and easily.

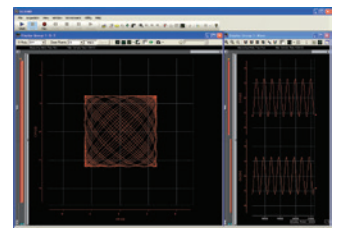

Accumulating Waveforms

Using the accumulation feature, you easily view unevenness of repetitive data.

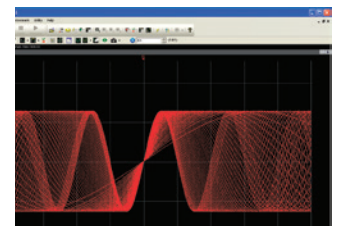

Setting Marks

You can enter comments in the Mark area when monitoring over long periods of time (Free Run mode).

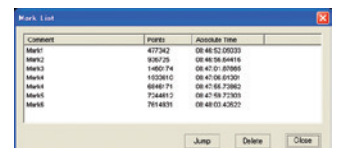

Waveform Measuring ScopeCorder Accessories

Product	Model No.	Description ^{*1}		
10:1 Probe	Wide temperature range, for isolated BNC input	702902	-40 to +85°C, DC to 60 MHz, 1000 Vpk-CAT II	
	For Isolated BNC Input	700929	1000 Vpk-CAT II	
Current Probe	701917	5 Arms, DC to 50 MHz, High-sensitivity		
	701918	5 Arms, DC to 120 MHz, High-sensitivity		
	701933	30 Arms, DC to 50 MHz, supports probe power		
	701930	150 Arms, DC to 10 MHz, supports probe power		
	701931	500 Arms, DC to 2 MHz, supports probe power		
	701932	30 Arms, DC to 100 MHz, supports probe power		
	702915	30 Arms, 5 Arms, 0.5 Arms (changeable), DC to 50 MHz, supports probe power		
	702916	30 Arms, 5 Arms, 0.5 Arms (changeable), DC to 120 MHz, supports probe power		
Clamp-on Probe	720930	AC 50 Arms		
	720931	AC 200 Arms		
Probe Power Supply	701934	Supply (4 outputs), large current output, external probe power		
1:1 Safety BNC Adapter Lead (in combination with followings)	701901	1000 Vrms-CAT II		
	Pinchers Tip (Hook type)	758928	1000 Vrms-CAT III, 1 set each of red and black	
	Large Alligator-Clips (Dolphin type)	701954	1000 Vrms-CAT II, 1 set each of red and black	
	Alligator Adapters	758922	300 Vrms CAT II, 1 set each of red and black	
	Alligator Adapters	758929	1000 Vrms CAT II, 1 set each of red and black	
	Fork Terminal Adapters	758921	1000 Vrms CAT II, 1 set each of red and black	
Passive Probe (10:1) ^{*2}	701940	Non-isolated 600 Vpk		
1:1 BNC-Alligator Cable	366926	Non-isolated 42 V or less, 1 m		

*1: Actual allowable voltage is the lower of the voltages specified for the main unit, probe and cable.

*2: 42 V is safe when using the 701940 with an isolated type BNC input.

Module and accessory combinations

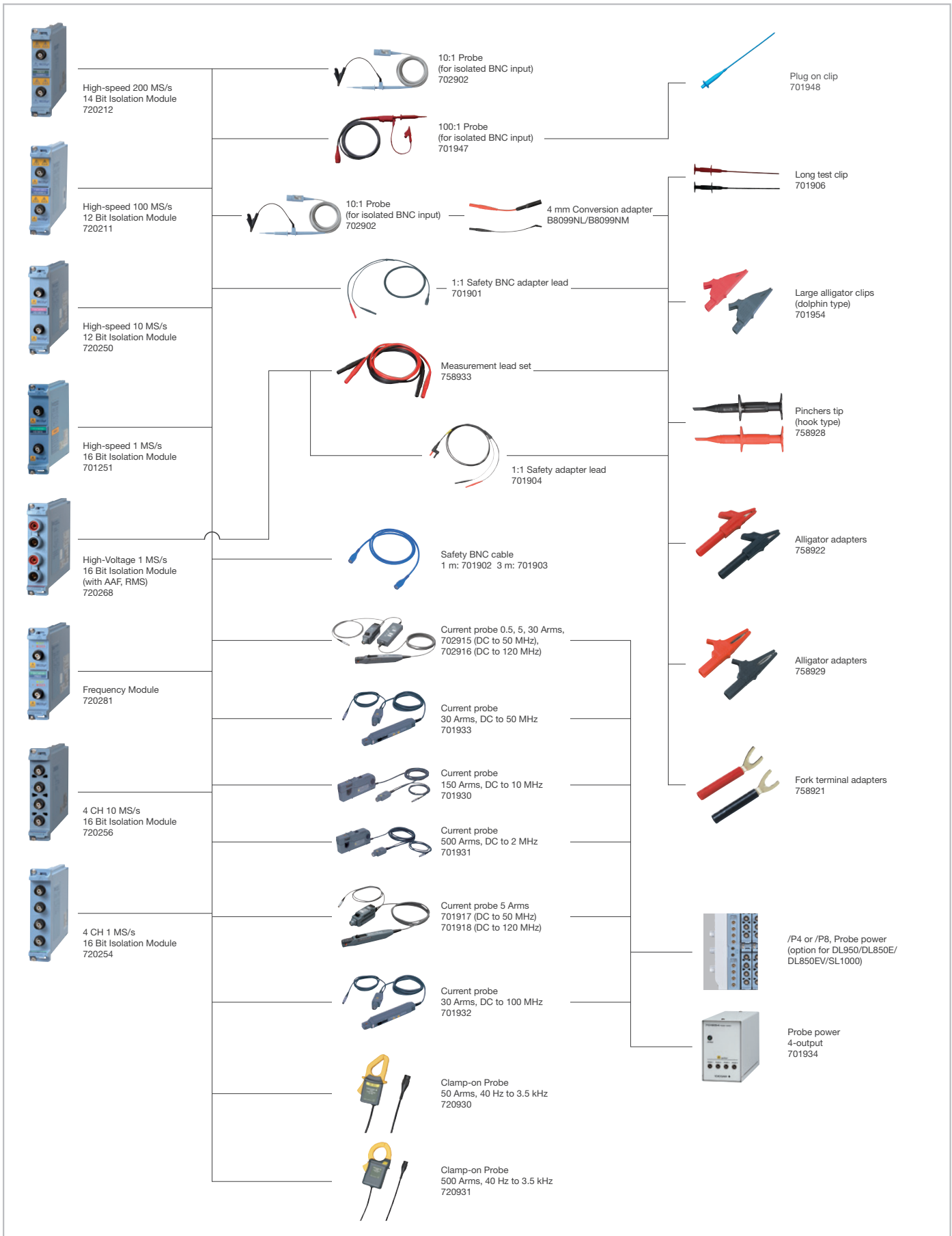

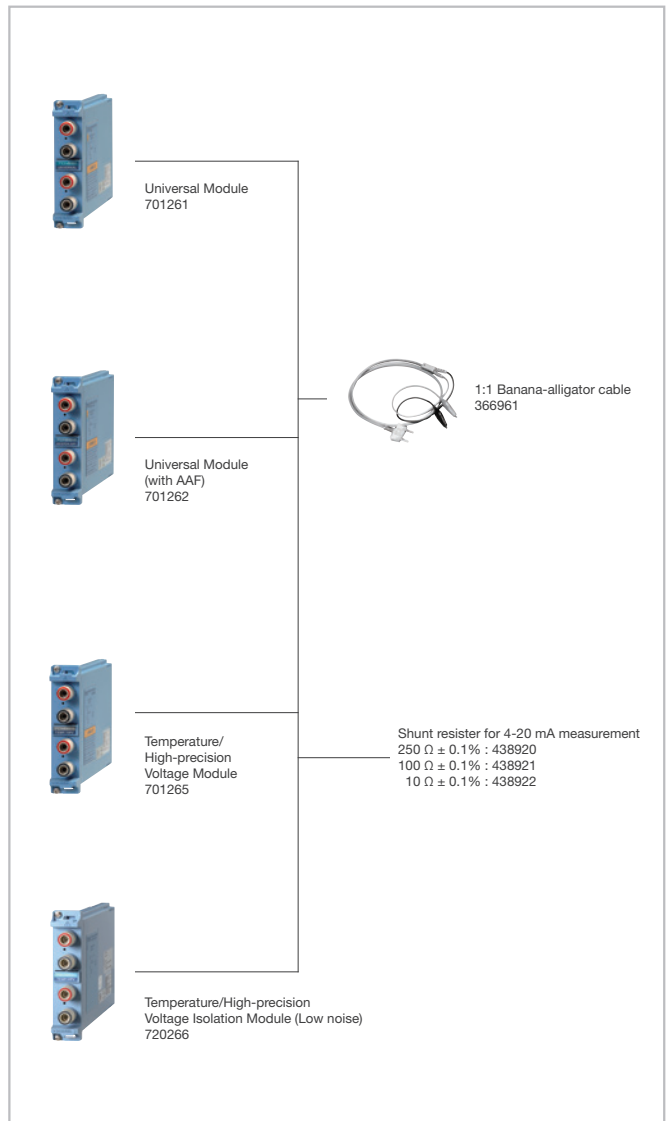
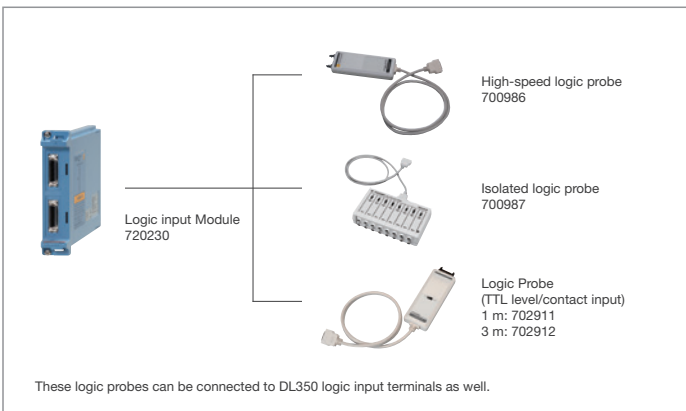
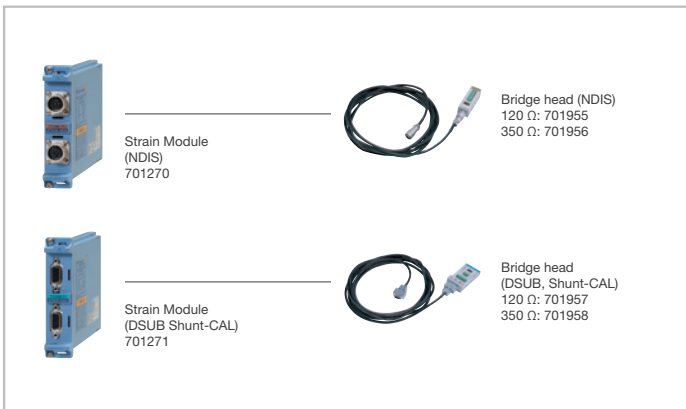
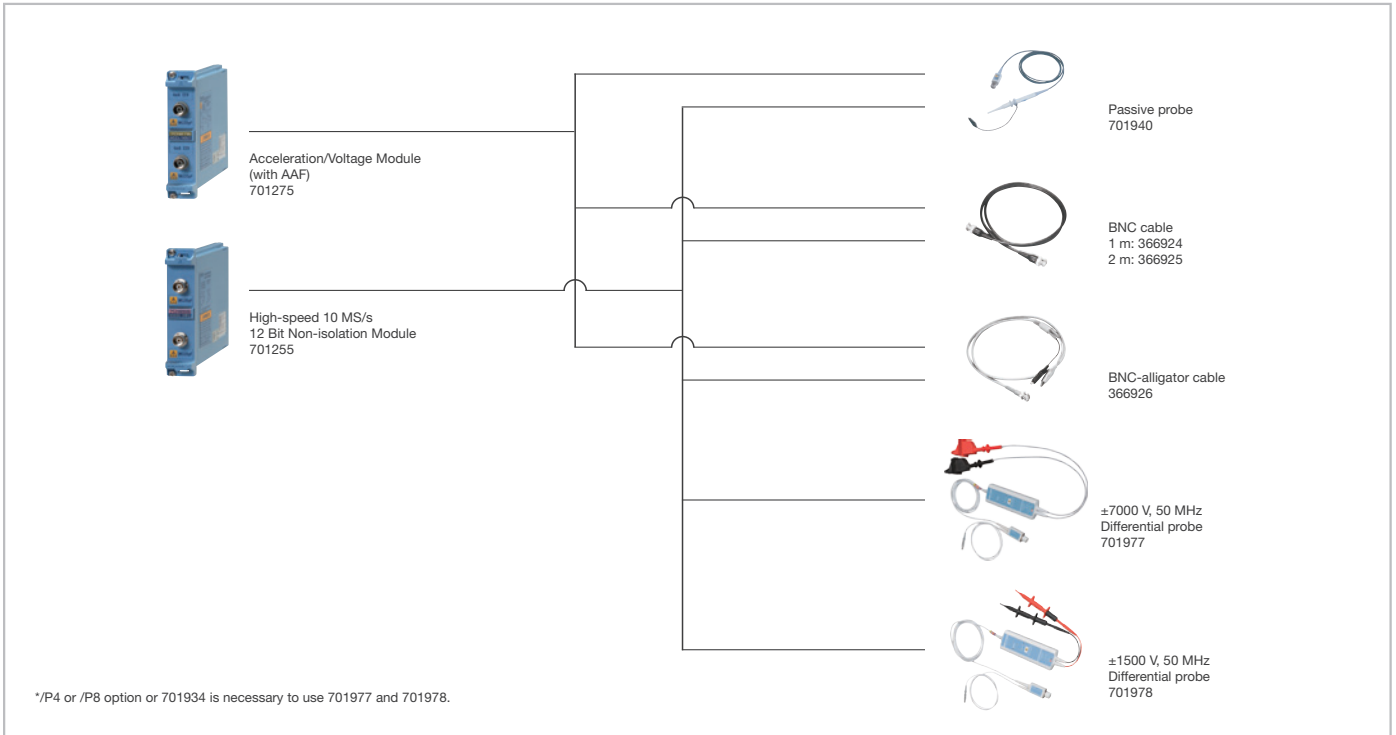

Waveform Measuring Digital and Mixed Signal Oscilloscopes

The DLM series digital oscilloscopes have high-speed sampling and a wide range of bandwidths that can be utilized for design and development of electronic devices.

They can also execute computations on repetitive waveforms and automatically extract waveform parameters.

The DLM series offers an extensive selection of digital oscilloscopes with large-capacity memories, powerful triggering functions, unique History function and built-in printers. It also can save and load data to and from internal or external media.

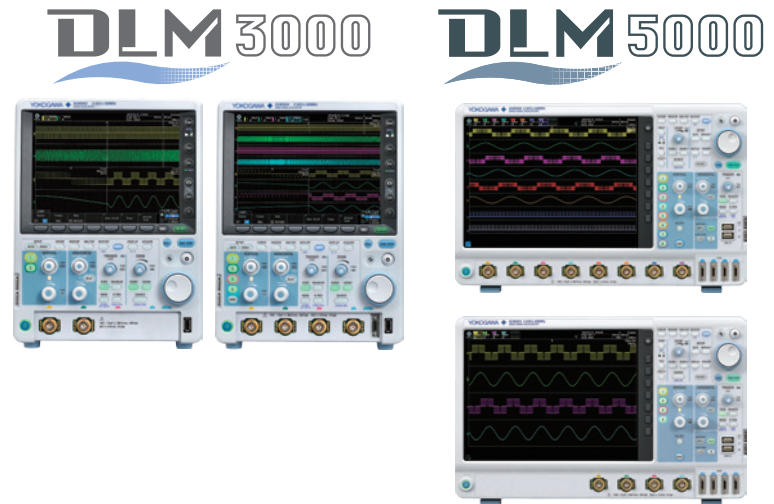

Selection Guide*1

Item		Model	DLM3000 Series ...P.20	DLM5000 Series ...P.22
Features			Compact & lightweight Analog 4 ch/Analog 3 ch + Logic 8 bits Long memory UART, I ² C, SPI, CAN, CAN FD, LIN, CXPI, FlexRay and SENT bus analysis functions Power supply analysis functions	Analog 8 ch + Logic 32 bits/Analog 4 ch + Logic 32 bits Long memory UART, I ² C, SPI, CAN, CAN FD, LIN, CXPI, PSI5, FlexRay and SENT bus analysis functions Power supply analysis functions Large display
Max. sampling rate			2.5 GS/s (All channels)	2.5 GS/s (All channels)
Bandwidth			500 MHz ²	500 MHz ²
Number of analog input channels			DLM3024, DLM3034, DLM3054: 4 DLM3022, DLM3032, DLM3052: 2	DLM5038, DLM5058: 8 DLM5034, DLM5054: 4
Logic input	Standard		DLM3024, DLM3034, DLM3054: Standard 8 bits (included as standard/optionally deletable)	16 bits
	Optional		—	32 bits
Max. vertical sensitivity (1:1)			500 μ V/div	500 μ V/div
Vertical axis resolution			8 bits	8 bits
Max. sweep sensitivity			1 ns/div	1 ns/div
Max. record length	Standard		125 Mpoints	125 Mpoints
	Optional		500 Mpoints	500 Mpoints
Internal storage	Standard		Approx. 300 MB	Approx. 1.7 GB
	Optional		Approx. 60 GB	Approx. 64 GB
Interface	Standard		USB/Ethernet	USB/Ethernet
	Optional		GP-IB	GP-IB
Built-in printer	Optional		112 mm width	112 mm width
Others	Optional		I ² C bus analysis SPI bus analysis CAN, CAN FD, LIN and CXPI bus analysis FlexRay bus analysis SENT analysis UART analysis Probe Power Power supply analysis functions User-defined math functions	I ² C bus analysis SPI bus analysis CAN, CAN FD, LIN and CXPI bus analysis FlexRay bus analysis SENT analysis UART analysis PSI5 analysis Probe Power Power Supply analysis functions User-defined math functions Two-unit connection function "DLMsync"
Display (TFT LCD)			8.4-inch color, XGA (Capacitive touch screen)	12.1-inch color XGA (Capacitive touch screen)
External dimensions W x H x D (mm)			226 x 293 x 193	426 x 266 x 180
Weight (kg)			Approx. 4.2	Approx. 7.3

*1: See each product catalog for more detailed specifications.

*2: Depends on model

Common Features of DLM Series

Multichannel

This feature meets the need to measure as many signals as possible simultaneously with one oscilloscope.

DLM3000 series

The DLM3000 series usually functions as 4 channel analog, and is able to switch CH 4 of analog input to 8-bit logic quickly whenever the need arises.

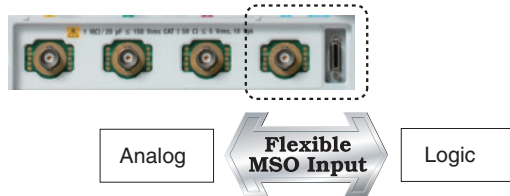

DLM5000 series

Up to 8 channels of analog signals can be measured. Furthermore, up to 16 analog channels and 64 bits of logic can be measured synchronously between two DLM5000 units with a dedicated cable. The dedicated interface is standard on the instrument and is available immediately with an optional additional license. (Available soon)



ScopeCorder Series is available for customers that require more channels for measurement (see page 6).

Long Memory

When the sample rate is increased with oscilloscopes with less memory, the observation time may run out. All of Yokogawa's oscilloscope models are equipped with large capacity memory. For example, the DLM3000 and DLM5000 offers long memory of up to 500 Mpoints for measurement.

Even at a fast sample rate of 2.5 GS/s, waveforms for 0.2 seconds can be captured.

The History function that divides the long memory can redisplay past waveforms that have disappeared from the screen.

With the DLM3000/DLM5000 series, up to 100000 previously captured waveforms can be saved in memory.

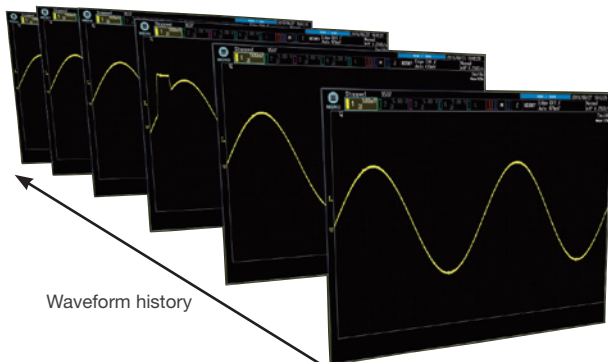

Since a large amount of data is also processed at high speed by dedicated hardware, the long memory can be used comfortably without sacrificing response time.

Connection with a PC

To facilitate the use of a PC, various interfaces such as USB, Ethernet, and GP-IB are available as standard or an option. In addition, various software is available to support remote control, file transfer, and data processing on a PC. USB memory and peripheral devices, such as keyboard and mouse, can be connected, and connecting to a PC using a USB cable enables it to be used as the external storage of the PC.

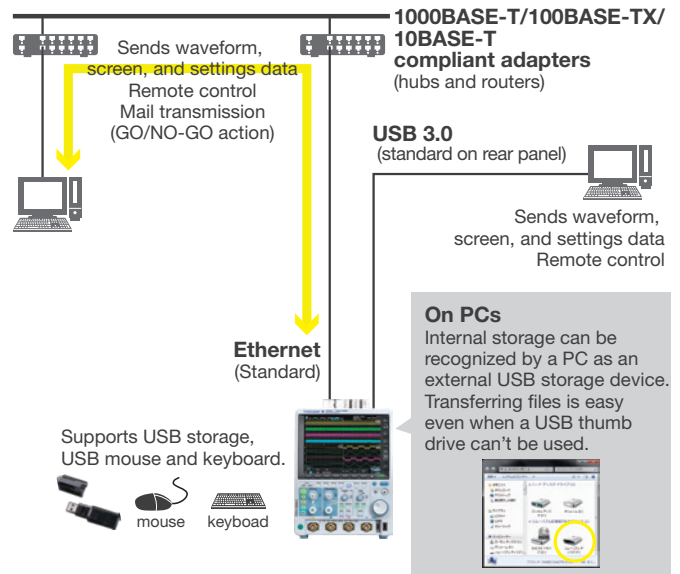

Built-in Printer

With a small built-in printer, measured waveforms can be printed to paper immediately.

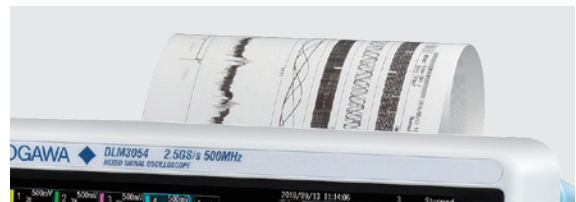

A Variety of Triggers and Analysis Functions

- A variety of triggers capture complex waveforms
- Real time digital filter with optimum noise reduction
- Zooms into two different points simultaneously
- Automated measurement of waveform parameters and statistical processing function
- Frequency analysis by FFT computation
- Go/No-Go function and action on trigger function to determine abnormal waveforms and save files
- Analysis functions for specific applications, such as serial bus analysis and power supply analysis

Easy and intuitive operation with touch screen

- Rect Zoom for easy zooming by swiping your finger diagonally across the screen to specify the area.
- To select items on the dialog box, you can directly touch them, which eliminates the trouble of using select keys.

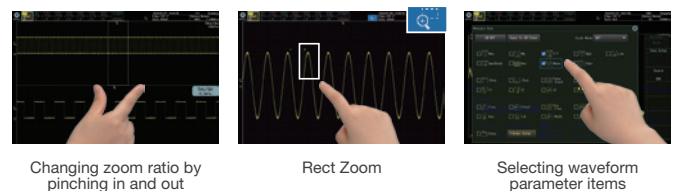

Mixed Signal Oscilloscope **DLM3000 Series**

Easy-to-Use, Portrait Body, Compact, and Large Touch Screen Personal Mixed Signal Oscilloscope



Basic Specifications

Analog Signal input	
Input channels	Analog input DLM30x4: CH1 to CH4 (CH1 to CH3 when using logic input) DLM30x2: CH1, CH2
Input coupling setting	AC 1 M Ω , DC 1 M Ω , DC 50 Ω
Input impedance	Analog input 1 M Ω \pm 1.0%, approximately 16 pF 50 Ω \pm 1.0% (VSWR 1.4 or less, DC to 500 MHz)
Voltage axis sensitivity setting range	1 M Ω 500 μ V/div to 10 V/div (steps of 1-2-5) 50 Ω 500 μ V/div to 1 V/div (steps of 1-2-5)
Max. input voltage	1 M Ω Must not exceed 300 Vrms or 400 Vpeak 50 Ω Must not exceed 5 Vrms or 10 Vpeak
Max. DC offset setting range	1 M Ω 500 μ V/div to 50 mV/div \pm 1 V 100 mV/div to 500 mV/div \pm 10 V 1 V/div to 10 V/div \pm 100 V 50 Ω 500 μ V/div to 50 mV/div \pm 1 V 100 mV/div to 1 mV/div \pm 5 V

Frequency characteristics (-3 dB attenuation when inputting a sinewave of amplitude ± 3 div)^{1, 2}

		DLM302x	DLM303x	DLM305x
1 M Ω (when using attached 10:1 passive probe)	20 mV to 100 V/div	200 MHz	350 MHz	500 MHz
	10 mV/div	200 MHz	350 MHz	350 MHz
	5 mV/div	200 MHz	200 MHz	200 MHz
50 Ω	2 mV to 10 V/div	200 MHz	350 MHz	500 MHz
	1 mV/div	200 MHz	350 MHz	350 MHz
	500 μ V/div	200 MHz	200 MHz	200 MHz

Maximum sample rate Real time sampling mode: 2.5 GS/s
Repetitive sampling mode: 250 GS/s

Maximum record length (Points)	Repeat		Single (when odd ch only)
	2 ch model	12.5 M	50 M (125 M)
4 ch model		12.5 M	50 M (125 M)
	/M1	25 M	125 M (250 M)
	/M2	50 M	250 M (500 M)

Logic Signal Input (4 ch model only)

Number of inputs	8 bit (excl. 4 ch input and logic input)
Maximum toggle frequency ¹	Model 701988: 100 MHz, Model 701989: 250 MHz
Compatible probes	701988, 701989 (8 bit input)

Display

Display³ 8.4-inch TFT color liquid crystal display, 1024 \times 768 (XGA)

General Specifications

Rated supply voltage	100 to 120 VAC/220 to 240 VAC (Automatic switching)
Rated supply frequency	50 Hz/60 Hz
Maximum power consumption	180 VA
External dimensions	226 (W) \times 293 (H) \times 193 (D) mm (when printer cover is closed, excluding protrusions)
Weight	Approx. 4.2 kg, With no options
Operating temperature range	5°C to 40°C

¹ Measured under standard operating conditions after a 30-minute warm-up followed by calibration.

² Value in the case of repetitive phenomenon.

³ The LCD may include a few defective pixels (within 3 ppm over the total number of pixels including RGB).

Features

Easy-to-Use & Easy-to-See

Easy to use. Portrait body + large touch screen

We elevated the large (8.4-inch) LCD screen up into the line of sight. Also, the portrait format saves space on the desk or test bench. A compact personal oscilloscope designed for easy viewing and ease of use.

- 8.4-inch XGA LCD & Capacitive touch screen
- Vertical Position and Scale Knob
- Horizontal Position and Scale Knob
- Trigger Control Keys and Level Knob
- Dedicated Zoom Keys
- Logic input connector
- USB peripheral connection terminal
- Jog Shuttle and Rotary Knob
- Four-Direction Selector Button Select key moves the cursor up/down/left/right



Large screen in a compact body
Footprint is approximately 2/3 the size of an A4 size paper (depth of approximately 200 mm)

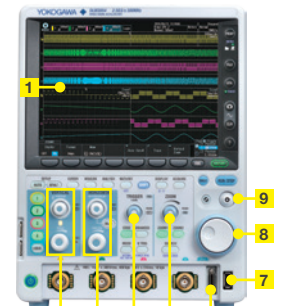

Signal observation on 4 channels or more...

Flexible MSO Input

Four channels is not sufficient to view the functioning of digital control circuits. The DLM3000 series converts 4 channels of analog input to 8-bit logic, and functions as a 3 channel analog + 8-bit logic MSO (mixed signal oscilloscope).

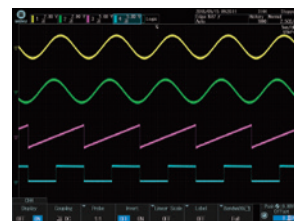

4 ch analog

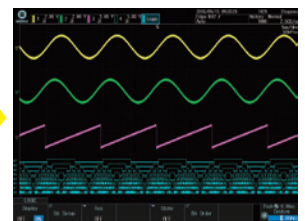

3 ch analog + 8-bit logic

You can replay waveforms later on, so you'll never miss an abnormal waveform

History function

With the DLM3000 series, up to 100000 previously captured waveforms can be saved in the acquisition memory. With the History function, you can display just one or all of the previously captured waveforms (history waveforms) on screen. You can also perform cursor measurement, computation, and other operations on history waveforms. Using the History function, you can analyze rarely-occurring abnormal signals.

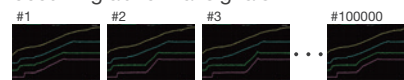

View individual captures to identify the relationship between channels at a specified moment in time.

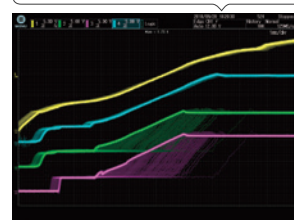

All waveform display mode

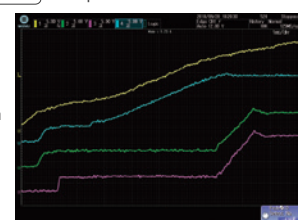

One waveform display mode

Even complex waveforms can be captured

Variety of triggers combining analog and logic inputs

The DLM3000 series comes with a variety of triggers ranging from an easy and simple Edge trigger through to sophisticated Enhanced and B triggers. In particular, its ability to freely combine analog and logic inputs is a great feature of this mixed signal oscilloscope.

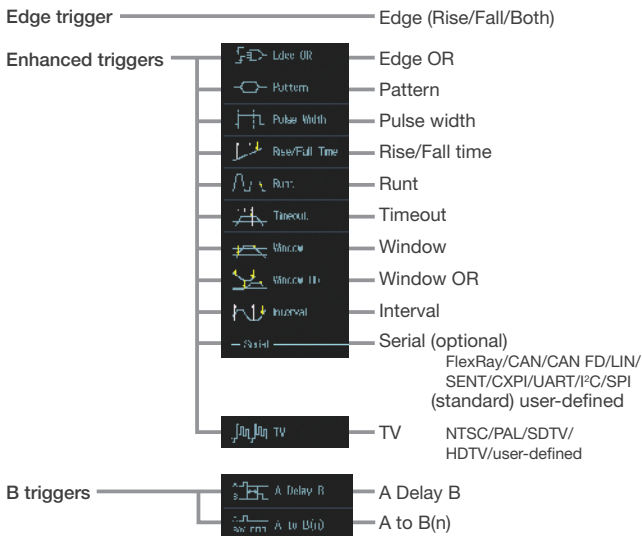

Optimum noise reduction

Real time filters and filters based on MATH functions

The DLM3000 series has two types of filters, one real time processed at the input circuit and one based on MATH functions. Since the cutoff frequency can also be finely set, these filters are effective in rejecting unwanted signals and observing only the desired signals.

Waveform zoom and search functions

Zoom two locations simultaneously, zoom search and history search

Because the DLM3000 series lets you set zoom factors independently, you can display two zoomed waveforms with different time axis scales at the same time. Also, using the search functions, you can search the long memory and History waveforms and instantaneously find desired waveforms that meet the search criteria.

Can check functions with graphical help

Graphical online help

You can view detailed graphical explanations of the oscilloscope's functions and operations by pressing the "?" key in the lower right of the screen. This lets you get help on functions and operations on screen without having to consult the user's manual.

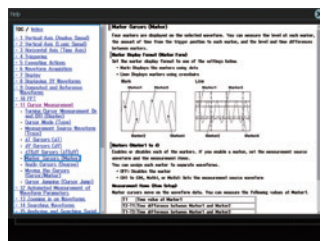

Analysis Functions

FlexRay/UART/CAN/CAN FD/LIN/CXPI/SENT/I²C/SPI

Serial analysis function options

A wide variety of trigger conditions can be set, such as ID/Data trigger combinations and combinations of serial bus triggers with normal edge triggers. Up to four busses with different types and speeds can be analyzed simultaneously and decode display can be shown in real time.

Switching loss, power measurement, joule integral, SOA analysis, and harmonic current based on EN61000-3-2

Power supply analysis option

Utilizing the long memory capability, voltage and current waveforms over long cycles can be input for computation of switching loss $[V(t) \times i(t)]$. A wide variety of switching loss analyses are supported, including turn on/off loss calculation, loss including conduction loss, and loss over long cycles (50 Hz/60 Hz). Automated measurement of power parameters for up to two pairs of voltage and current waveforms, such as active power, apparent power, power factor and so on.

Model and Suffix Codes

Model ¹	Suffix code	Description	
DLM3022		Digital Oscilloscope: 2 ch, 200 MHz	
DLM3024 ²		Mixed Signal Oscilloscope: 4 ch, 200 MHz	
DLM3032		Digital Oscilloscope: 2 ch, 350 MHz	
DLM3034 ²		Mixed Signal Oscilloscope: 4 ch, 350 MHz	
DLM3052		Digital Oscilloscope: 2 ch, 500 MHz	
DLM3054 ²		Mixed Signal Oscilloscope: 4 ch, 500 MHz	
Power cord	-D	UL/CSA Standard and PSE compliant	
	-F	VDE/Korean Standard	
	-Q	British Standard	
	-R	Australian Standard	
	-H	Chinese Standard	
	-N	Brazilian Standard	
	-T	Taiwanese Standard	
	-B	Indian Standard	
	-U	IEC Plug Type B	
	Language	-HJ	Japanese message and panel
-HE		English message and panel	
-HC		Chinese message and panel	
-HG		German message and panel	
-HF		French message and panel	
-HK		Korean message and panel	
-HL		Italian message and panel	
-HS		Spanish message and panel	
Option		/LN	No switchable logic input (4 ch model only)
		/B5	Built-in printer (112 mm)
	/M1 ³	Memory expansion option (4 ch model only) During continuous measurement: 25 Mpoints; Single mode: 125 Mpoints/250 Mpoints ⁴	
	/M2 ³	Memory expansion option (4 ch model only) During continuous measurement: 50 Mpoints; Single mode: 250 Mpoints/500 Mpoints ⁴	
	/P2 ⁵	2 probe power terminals (for 2 ch model)	
	/P4 ⁵	4 probe power terminals (for 4 ch model)	
	/C1	GP-IB interface + GO/NO-GO terminal	
	/C8	Internal storage (60 GB)	
	/G02	User-defined math function (4 ch model only)	
	/G03	Power supply analysis function (4 ch model only)	
	/F01	UART + I²C + SPI trigger and analysis (4 ch model only)	
	/F02	CAN + CAN FD + LIN trigger and analysis (4 ch model only)	
	/F03	FlexRay trigger and analysis (4 ch model only)	
	/F04	SENT trigger and analysis (4 ch model only)	
	/F05	CXPI trigger and analysis (4 ch model only)	
/EX2 ⁶	Replace all probes with 701949 (2 ch model only)		
/EX4 ⁶	Replace all probes with 701949 (4 ch model only)		

Standard Main Unit Accessories

Power cord, Passive probe⁷, Protective front cover, Panel sheet⁸, Soft carrying case for probes, Printer roll paper (for /B5 option), User's manuals⁹

¹: Standard memory capacity: During continuous measurement: 12.5 Mpoints; Single mode: 50 Mpoints/125 Mpoints (when odd channels only) ²: Logic probes sold separately. Please order the model 701988/701989 accessory logic probes separately. ³, ⁶: When select from these options, please select only one. ⁴: When odd channels only ⁵: Specify this option when using current probes or other differential probes that don't support probe interface. ⁷: 701937, per number of channels. When either /EX2 or /EX4 option is selected, no 701937 is included. ⁸: Except suffix code "-HE". ⁹: Start guide as the printed material, and User's manual as CD-ROM are included.

Additional Option License for DLM3000^{*1}

Model	Suffix code	Description
709811	-G02	User defined math
	-G03	Power supply analysis function
	-F01	UART + I²C + SPI trigger and analysis
	-F02	CAN + CAN FD + LIN trigger and analysis
	-F03	FlexRay trigger and analysis
	-F04	SENT trigger and analysis
	-F05	CXPI trigger and analysis

^{*1}: Separately sold license product (customer-installable). (4 ch model only)

Mixed Signal Oscilloscopes **DLM5000**

The unique eight analog channel 500 MHz oscilloscope for faster and more advanced power electronics, automobile electronics, and mechatronics development.

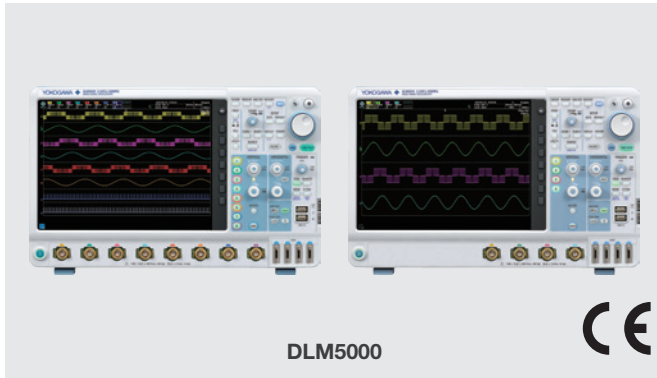

Basic Specifications

Models				
Model name	Frequency bandwidth	Analog input	Logic input	Max. sample rate
DLM5038	350 MHz	8 channels	16 bit (Standard) or 32 bit (L32)	2.5 GS/s
DLM5058	500 MHz			
DLM5034	350 MHz	4 channels		
DLM5054	500 MHz			

Analog Signal input	
Input channels	DLM50x8: CH1 to CH8 DLM50x4: CH1 to CH4
Input coupling setting	AC 1 M Ω , DC 1 M Ω , DC 50 Ω
Input impedance	Voltage axis sensitivity setting range: 1 M Ω 500 μ V/div to 10 V/div (steps of 1-2-5) 50 Ω 500 μ V/div to 500 mV/div (steps of 1-2-5)
Vertical-axis (voltage-axis) DC accuracy*1	500 μ V/div \pm (3.0% of 8 div + offset voltage accuracy) 1 mV/div to 10 V/div \pm (1.5% of 8 div + offset voltage accuracy)
A/D conversion resolution	8 bit (25 LSB/div) Max. 12 bit (in High Resolution mode)

Logic Signal Input	
Maximum toggle frequency	100 MHz (701988) or 250 MHz (701989)
Probes that can be used	701988 and 701989 (701980 and 701981)
Minimum input voltage	500 mVp-p (701988) or 300 mVp-p (701989)
Input range	\pm 40 V (701988), Threshold level \pm 6 V (701989)
Maximum non-destructive input voltage	\pm 40 V (DC + AC peak) or 28 Vrms (701989)
Threshold level setting range	\pm 40 V (701988) or \pm 6 V (701989)

Common Specifications	
Maximum sampling rate	Real-time sampling mode: 2.5 GS/s Repetitive sampling mode: 250 GS/s
Time axis setting range	1 ns/div to 500 s/div
Maximum record length (Points)	Repeat Single (when odd ch only)
	Standard model 12.5 M 50 M (125 M)
	/M1 or /M1S 25 M 125 M (250 M)
	/M2 or /M2S 50 M 250 M (500 M)
History memory maximum data	100000 (record length 1.25 kPoints; /M2 or /M2S) 20000 (record length 1.25 kPoints; standard)
Trigger modes	Auto, Auto Level, Normal, Single, N-Single, Force
Trigger types	Edge, Edge OR, Pulse Width, Timeout, Pattern, Runt, Rise/Fall Time, Interval, Window, Window OR, TV, Serial Bus (I ² C/SPI/UART/CAN/CAN FD/LIN/FlexRay/SENT/CXPI/PSI5/UserDefine), A Delay B, A to B (N)

Internal storage	1.7 GB (standard) or 64 GB (/C8 option)
Interfaces	USB peripheral connection terminal \times 2 USB-PC connection terminal \times 1 Ethernet (standard), GP-IB (option)
Build-in printer	112 mm wide, monochrome, thermal
Display	12.1-inch TFT LCD with a capacitive touch screen, 1024 \times 768 (XGA)
Dimensions	426 (W) \times 266 (H) \times 180 (D) mm
Weight	Approx. 7.2 kg (with no options)

Features

The unique analog 8-channel input oscilloscope has been redesigned and redesigned. DLMsync meets your demand for even more multichannel measurements.

- 8 analog channels (DLM50x8) or 4 analog channels (DLM50x4), and 16 bits logic input for each models
- Optional 16-bit logic input
- Up to 2.5 GS/s
- 350 MHz or 500 MHz frequency bandwidth
- 12.1-inch large display and intuitive touch screen operation
- Large memory of up to 500 Mpoints
- Light, slim, and compact design

Applications

8ch Motor Control and Inverter/IPM Circuit Development

Simultaneous multi-channel measurements are a necessity for the development of control circuits, Intelligent Power Module (IPM), and inverter electronics, which are the key to more efficient, compact, and reliable high-performance motors. Up to 8-channel analog waveform measurement of the DLM5000 empowers engineers in this field.

Examples

- Simultaneous measurement of the 3-line voltage and 3-phase current of a 3-phase motor
- Simultaneous measurement of the gate control signals of 6 IGBTs within an inverter

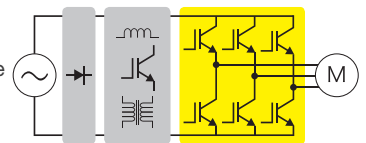

4ch Limitations of 4 ch Scope

Whole-system measurement is impossible due to a lack of analog input channels when, for example, measuring the overall timing of the control signals, checking an error of the phase-to-phase balance between 3 phases, and simultaneously measuring the I/O signals of a motor driver IC.

8ch Automobile ECU and Integrated Mechatronics Device Development

Electronic Control Unit (ECU) and controller I/O signals must be measured simultaneously at high speed. To meet this requirement, the DLM5000 offers eight analog channels, logic measurement, and protocol analysis (communication data decoding) functions such as UART (RS232), I²C, SPI, CAN, CAN FD, LIN, SENT, CXPI and FlexRay to help speed up the R&D process.

Examples

- Simultaneous measurement of controller I/O signals and serial bus signals
- Measurement of the analog behavior of logic signals and serial bus signals

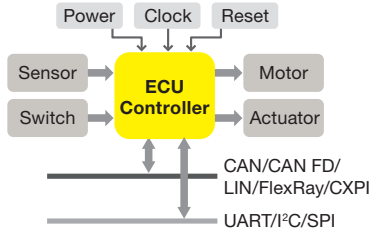

4ch Limitations of 4 ch + 16-bit MSO

ECUs, controllers, and driver ICs handle many I/O signals but the 4-channel + 16-bit MSO cannot measure all the signals. Furthermore, it measures bus communication signals and digital signals using logic input so it cannot measure waveform quality and noise margin. Therefore, it is difficult to increase stability and reliability.

Recorder Limitations of Memory Recorder

A memory recorder is generally suitable for long-time multi-channel measurement, but due to its low sampling rate and slow waveform update speed, its performance is not adequate for measuring high-speed signals and communication signals of CPUs and FPGAs, or detecting noise that causes problems or error signals.

The portable eight-channel DLM5000 is the daily instrument of choice. Maximum easiness of use coupled with minimum depth and weight. 12.1-inch large LCD display enables eight waveforms to be easily viewed

8 channel model DLM50x8

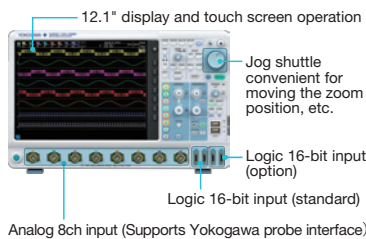

4 channel model DLM50x4

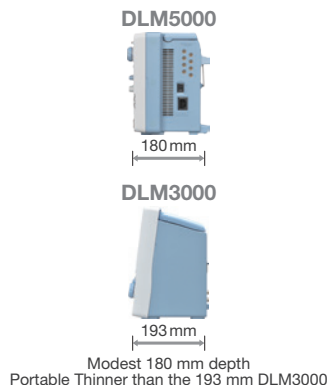
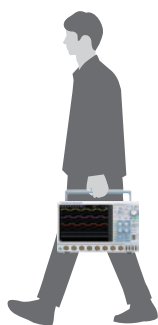
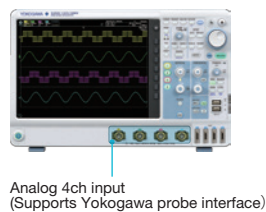

Model and Suffix code

Model ¹	Suffix code	Description
DLM5038		Mixed Signal Oscilloscope: 8 ch, 350 MHz
DLM5058		Mixed Signal Oscilloscope: 8 ch, 500 MHz
DLM5034		Mixed Signal Oscilloscope: 4 ch, 350 MHz
DLM5054		Mixed Signal Oscilloscope: 4 ch, 500 MHz
Power cord	-D	UL/CSA Standard and PSE compliant
	-F	VDE/Korean Standard
	-Q	British Standard
	-R	Australian Standard
	-H	Chinese Standard
	-N	Brazilian Standard
	-T	Taiwanese Standard
Language	-B	Indian Standard
	-U	IEC Plug Type B
	-HJ	Japanese message and panel
	-HE	English message and panel
	-HC	Chinese message and panel
	-HG	German message and panel
	-HF	French message and panel
Option	-HK	Korean message and panel
	-HL	Italian message and panel
	-HS	Spanish message and panel
	/L32	Expansion logic 16bit (Total 32 bit)
	/B5	Built-in printer (112 mm)
	/M1 ²	Memory expansion option (8 ch model only) During continuous measurement: 25 Mpoints; Single mode: 125 Mpoints/250 Mpoints ³
	/M2 ²	Memory expansion option (8 ch model only) During continuous measurement: 50 Mpoints; Single mode: 250 Mpoints/500 Mpoints ³
	/M1S ²	Memory expansion option (4 ch model only) During continuous measurement: 25 Mpoints; Single mode: 125 Mpoints/250 Mpoints ³
	/M2S ²	Memory expansion option (4 ch model only) During continuous measurement: 50 Mpoints; Single mode: 250 Mpoints/500 Mpoints ³
	/P8 ⁴	8 probe power terminals (for 8 ch model)
/P4 ⁴	4 probe power terminals (for 4 ch model)	
/C1	GP-IB interface	
/C8	Internal storage (64 GB)	
/SYN	Synchronous operation	
/G02	User-defined math function	
/G03	Power supply analysis function	
/F01	UART + I ² C + SPI trigger and analysis	
/F02	CAN + CAN FD + LIN trigger and analysis	
/F03	FlexRay trigger and analysis	
/F04	SENT trigger and analysis	
/F05	CXPI trigger and analysis	
/F06	PSI5 trigger and analysis	
/E1 ⁵	Four additional 701937 probes (8 in total) (for 8 ch model)	
/E2 ⁵	Attach four 701949 probes	
/E3 ⁵	Attach eight 701949 probes (for 8 ch model)	

Standard Main Unit Accessories

Power cord, Passive probe⁶, Protective front cover, Panel sheet⁷, Soft carrying case for probes, Printer roll paper (for /B5 option), User's manuals⁸





























¹: Standard memory capacity: During continuous measurement: 12.5 Mpoints; Single mode: 50 Mpoints/125 Mpoints (when odd channels only) Logic probes sold separately.
²,⁵: When selecting from these options, please select only one.
³: When odd channels only
⁴: Specify this option when using current probes or other differential probes that don't support probe interface.
⁶: Four 701937 except /E2 or /E3.
⁷: Except suffix code "-HE".
⁸: Start guide as the printed material, and User's manual as CD-ROM are included.

Additional Option License for DLM5000^{*1}

Model	Suffix code	Description
709821	-G02	User defined math
	-G03	Power supply analysis function
	-F01	UART + I ² C + SPI trigger and analysis
	-F02	CAN + CAN FD + LIN trigger and analysis
	-F03	FlexRay trigger and analysis
	-F04	SENT trigger and analysis
	-F05	CXPI trigger and analysis
-F06	PSI5 trigger and analysis	
-SYN	Synchronous operation	

^{*1}: Separately sold license product (customer-installable).

Waveform Measuring Oscilloscopes Accessories

Classification	Product	Model No.	Power supply		Description	Models		Appearance
			Probe interface terminal (front panel) ^{*1}	Probe power (option)/ probe power supply (sold separately)		DLM5000 DLM3000	DLM4000 DLM2000	
Passive	500 MHz passive probe	701937			DC to 500 MHz, 10:1, 1.3 meters	Yes	No	
	Miniature passive probe	701949			DC to 500 MHz, 10:1, 1.3 meters	Yes	No	
	10:1 Passive probe	702907			DC to 200 MHz, 10:1, 2.5 meters, -40°C to +85°C (Operating temperature range)	Yes	No	
	500 MHz passive probe	701939			DC to 500 MHz, 10:1, 1.3 meters	No	Yes	
	500 MHz Miniature passive probe	701946			DC to 500 MHz, 10:1, 1.2 meters	No	Yes	
	200 MHz passive probe (wide temperature range)	702906			DC to 200 MHz, 10:1, 2.5 meters, -40°C to +85°C (Operating temperature range)	No	Yes	
Passive (High-voltage)	100:1 High voltage probe	701944			DC to 400 MHz, 100:1, 1.2 meters			
	100:1 High voltage probe	701945			DC to 250 MHz, 100:1, 3.0 meters			
FET	900 MHz FET Probe	700939		Yes	DC to 900 MHz, 1.5 meters			
Low Capacitance	5 GHz low capacitance probe (PBL5000)	701974			DC to 500 MHz, 10:1 / 20:1, 1.1 meters			
Differential	1 GHz differential probe (PBDH 1000)	701924	Yes		DC to 1 GHz, 50:1, Max. differential input voltage: ±25 V			
	500 MHz differential probe (PBDH 0500)	701925	Yes		DC to 500 MHz, 50:1, Max. differential input voltage: ±25 V (DC+ACpeak)			
	150 MHz differential probe (PBDH 0150)	701927	Yes		DC to 150 MHz, 50:1, 500:1, Max. differential input voltage: ±140 V (50:1), ±1400 V (500:1)			
	50 MHz high voltage differential probe	701977		Yes	DC to 50 MHz, 100:1, 1000:1, Max. differential input voltage: 5000 Vrms or less, and 7000 Vpeak or less			
	150 MHz differential probe	701978		Yes	DC to 150 MHz, 50:1, 500:1, Max. differential input voltage: ±1500 V (DC+ACpeak)			
Current	Current probe	702916		Yes	DC to 120 MHz, 0.5 Arms, 5 Arms, 30 Arms, 3 ranges			
	Current probe	702915		Yes	DC to 50 MHz, 0.5 Arms, 5 Arms, 30 Arms, 3 ranges			
	Current probe	701918		Yes	DC to 120 MHz, 5 Arms, High-sensitivity			
	Current probe	701917		Yes	DC to 50 MHz, 5 Arms, High-sensitivity			
	Current probe (PBC100)	701928	Yes		DC to 100 MHz, 30 Arms			
	Current probe (PBC050)	701929	Yes		DC to 50 MHz, 30 Arms			
	Current probe	701932		Yes	DC to 100 MHz, 30 Arms			
	Current probe	701933		Yes	DC to 50 MHz, 30 Arms			
	Current probe	701930		Yes	DC to 10 MHz, 150 Arms			
	Current probe	701931		Yes	DC to 2 MHz, 500 Arms			
Logic	100 MHz Logic probe (PBL100)	701988			Input impedance 1 MΩ, Max. toggle frequency: 100 MHz			
	250 MHz Logic probe (PBL250)	701989			Input impedance: 100 kΩ, Max. toggle frequency: 250 MHz			
Other	De-skew correction signal source	701936			Voltage/current signal de-skew Supports through-type current transformers and a variety of current probes, including large current probes.			
	Probe power supply	701934			Large current output, external probe power supply (4 outputs)			
	Probe stand	701919			Diameter of attachable probe 8 mm diameter to 13 mm Weight: Approx. 1.5 kg			
	Connection cable	701982-01			For synchronous operation of DLM5000 (DLMsync) 1 m			
701982-02				For synchronous operation of DLM5000 (DLMsync) 2.8 m				

These specifications are a summary. For details, please refer to the Web site, catalog, and other documentation. *1: Available as standard for the DLM5000, DLM4000, DLM3000, DLM2000, DLM6000 and DL6000 series.

In addition to those listed above, there are other accessories available. For details, please refer to the Web site. When using multiple current probes using the probe power of the main unit, ensure that the total power supply current of the current probes does not exceed the maximum output current of the probe power.

Oscilloscope Application Software 701992 Xviewer

Instrument control & data analysis on Your PC

Xviewer is a PC software application designed to work with Yokogawa's DLM/DL/SL series. Xviewer allows you to display acquired waveform data (using the "Viewer" function), perform file transfers, and control DLM/DL/SL series from a PC.

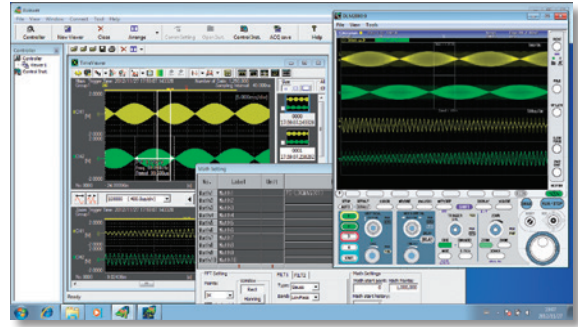

Oscilloscope Application Software XviewerLITE (Free software)

Free data viewer

XviewerLITE is a free data viewer software for DLM/DL/SL series. It allows you to display acquired waveform on a PC. Zoom, vertical cursor measurement and CSV format conversion are possible.

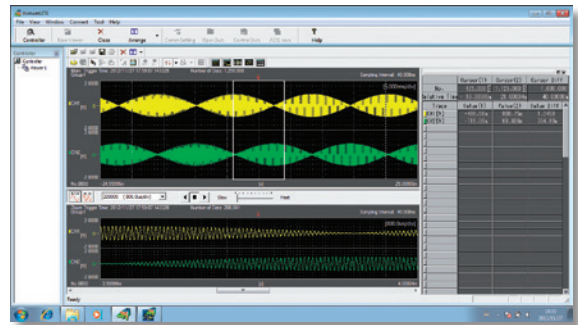

Oscilloscope Application Software XWirepuller/Wirepuller (Free software)

Remote Control Measuring Instrument on Your PC

With this software, you can display the front panel of the DLM/DL/SL series on the screen of a PC, and monitor waveform signals. You can perform control from the PC using the mouse and keyboard in the same way as you operate the main unit.

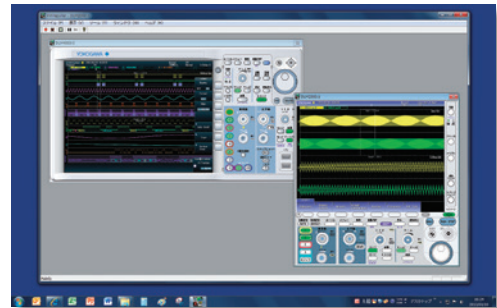





In addition to the above, various kinds of accessory software, free software, LabVIEW drivers, and LabWindows/CVI drivers, can be downloaded from our web site.

Selection Guide

Digital Power Analyzers

**Yokogawa's PX8000 and WT Series Power Meters and Power Analyzers:
Advanced Technology and High Reliability for a Wide Range of Power Measurement Solutions**

WT Series

Models	WT300E series	WT500	WT5000	WT1800E	PX8000
Items	 ...P32	 ...P27	 ...P28	 ...P30	 ...P34
Features	Entry Class Digital Power Meters 4 models line up, equipping 5 mA range (WT310E), 40 A range (WT310EH), and 2 or 3 CH inputs (WT332E/WT333E) Standard Communication I/F and auto-ranging under integration mode	Low-Middle Class Power Analyzer Compact half rack size and easy use Max. 1000 V and 40 A input Simultaneous measurement U, I, P and those harmonics components External USB memory for direct data saving	The world highest class accuracy Digital Power Analyzer with basic power accuracy of $\pm 0.03\%$ of total and DC & 0.1 Hz to 10 MHz voltage measurement bandwidth Up to 7 power input measurement with modular structure Data streaming, IEC harmonic/flicker test	Middle Class Digital Power Analyzer Up to six input elements in one instrument (3 phase power input from two systems in one unit) 8.4-Inch XGA TFT Color LCD Wide voltage and current input range Power supply for AC/DC current sensors (optional)	A power analyzer with capabilities of transient power measurement and waveform parameter measurement Fast sampling up to 100 MS/s, Broad bandwidth up to 20 MHz (-3 dB), Trend measurement of each cycle, Specified period measurement by cursors Power supply for AC/DC current sensors (optional)
Input elements	1(WT310E,WT310EH), 2 (WT332E), 3(WT333E)	1 to 3	Modular structure 1 to 7 power measurement element	1 to 6	Module structure, 1 to 4 power measurement element
Basic power accuracy (50/60 Hz)	$\pm (0.1\% \text{ of rdg} + 0.05\% \text{ of rng})$	$\pm (0.1\% \text{ of rdg} + 0.1\% \text{ of rng})$	$\pm (0.01\% \text{ of rdg} + 0.02\% \text{ of rng})$	$\pm (0.05\% \text{ of rdg} + 0.05\% \text{ of rng})$	$\pm (0.1\% \text{ of reading} + 0.1\% \text{ of range})$
Power measurement frequency range	DC, 0.1 Hz to 100 kHz (WT310EH is up to 20 kHz)	DC, 0.5 Hz to 100 kHz	DC, 0.1 Hz to 1 MHz	DC, 0.1 Hz to 1 MHz	DC, 0.1 Hz to 1 MHz
Input voltage range (for crest factor 3)	15/30/60/150/300/600/ V	15/30/60/100/150/300/600/1000 V	15/3/6/10/15/30/60/100/150/300/600/1000 V	15/3/6/10/15/30/60/100/150/300/600/1000 V	15/3/6/10/15/30/60/100/150/300/600/1000 V
Input current range (for crest factor 3)	Direct input: 5 m/10 m/20 m/50 m/100 m/200 m/500 m/1/2/5/10/20 A (WT310E) Direct input: 1/2/5/10/20/40 A (WT310EH) Direct Input: 500m/1/2/5/10/20 A (WT332E,WT333E) External input(option): 2.5/5/10 V, or 50 m/100 m/200 m/500 m/1/2 V	Direct input: 500 m/1/2/5/10/20/40 A External sensor input (option): 50 m/100 m/200 m/500 m/1/2/5/10 V	Direct input: 0.5/1/2/5/10/20/30 A (760901) or 5 m/ 10 m/ 20 m/ 50 m/ 100 m/ 200 m/ 500 m/1/2/5 A (760902) 760901 and 760902 can be installed together in one main unit. External sensor input: 50 m/ 100 m/ 200 m/500 m/1/2/5/10 V	Direct input: 10 m/20 m/50 m/100 m/200 m/ 500 m/1/2/5 A or 1/2/5/10/20/50 A External input (option): 50 m/100 m/250 m/500 m/ 1/2/5/10 V 5 A and 50 A can be mixed in one unit	Direct input: 10 m/20 m/50 m/100 m/ 200 m/500 m/1/2/5 A External sensor input: 50 m/100 m/ 250 m/500 m/1/2.5/5/10 V
Measurement parameters	Voltage, Current, Active power, Reactive power, Apparent power, Power factor, Phase angle, Peak voltage, Peak current, frequency, Crest factor, Integration (power and current), Harmonic distortion, Harmonic components	Voltage, Current, Active power, Reactive power, Apparent power, Power factor, Phase angle, Peak voltage, Peak current, Voltage frequency, Current frequency, Active power integration and Current integration for both charge/discharge and sold/bought, crest factor, Efficiency, harmonic analysis	Voltage, Current, Active power, Apparent power, Reactive power, Power factor, Phase angle, Peak voltage, Peak current, Voltage frequency, Current frequency, Active power integration, Current integration, Crest factor, Form factor, Impedance, Resistance, Reactance, Corrected Power, Harmonic analysis IEC regulation test	Voltage, Current, Active power, Apparent power, Reactive power, Power factor, Phase angle, Peak voltage, Peak current, Voltage frequency, Current frequency, Active power integration, Current integration, Crest factor, Form factor, Impedance, Resistance, Reactance, Corrected Power, Harmonic analysis	Voltage, Current, Active power, Reactive power, Apparent power, Power factor, Phase angle, Peak voltage, Peak current, Voltage frequency, Current frequency Transient voltage/current/power(Trend of waveform by cycle), Averaged voltage/ current/power by cursor(waveform parameters calculation)
Display	7 Segment LED, 4 displays	5.7-inch TFT color LCD	10.1-inch TFT color LCD (WXGA) with touch screen	8.4-inch XGA TFT color LCD	10.4 inch TFT color LCD (XGA)
External dimensions (mm) (W x H x D)	213 x 88 x 379 (WT310E and WT310EH) 213 x 132 x 379 (WT332E and WT333E)	213 x 177 x 408.5	426 x 177 x 469	426 x 177 x 459 426 x 221 x 459 (with/PD2)	355 x 259 x 180 355 x 259 x 245 (with/PD2)
Weight (kg)	3 (WT310E), 5 (WT330E)	6.5	12.5 (without input element)	15	6.5 (without any options and paper)

*About CW series Clamp-on Power Meters, please refer to the page 79.

Power Analyzer **WT500**

Compact and easy to use. The Power Analyzer for the renewable energy generation

**WT500**

Bulletin 7602-00E



Overview of a Photovoltaic Inverter Evaluation

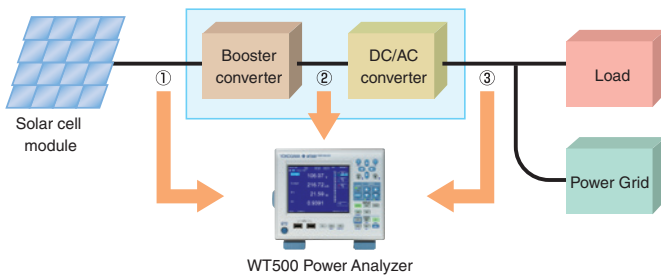

Basic Specifications

- Measurement voltage range: (for crest factor 3)
15/30/60/100/150/300/600/1000 V
- Measurement current range: (for crest factor 3)
Direct input 500 m/1/2/5/10/20/40 A
External sensor input (option)
50 m/100 m/200 m/500 m/1/2/5/10 V
- Frequency range:
DC, 0.5 Hz to 100 kHz
- Measurement Accuracy:
Basic Accuracy (45 Hz ≤ f ≤ 66 Hz and DC)
Voltage/Current/Power
± (0.1% of rdg*1 + 0.1% of rng*2)
- USB interface to PC is standard feature
- Ethernet communication function is available (optional)
- GP-IB communication function is available (optional)
- Effective of power factor (at cos φ = 0)
± 0.2% of S (apparent power)
- External dimensions:
Approx. 213(W) × 177(H) × 408.5(D) mm
- Weight: Approx. 6.5 kg (with 3-input element)

*1: rdg: reading *2: rng: range

Overview

The WT500 is a low-middle class power analyzer and it features a 5.7-inch color TFT and half width racking compact body that enables single-phase and three-phase power measurement, achieving ±0.2% of total basic and DC accuracy, maximum input of 1000 Vrms, 40 Arms and a measurement bandwidth up to 100 kHz.

Features

- Accurate efficiency measurement of DC and AC signals
- RMS, MEAN, DC, AC and RMEAN of voltages and currents simultaneous measurement
- Simultaneous measurement of normal U/I/P data and those harmonic data
- As fast as 100 ms data capturing and store data with all channels
- Separate integration functions for charge/discharge or bought/sold power
- Integration of power, reactive power, apparent power, and current enables you to determine a device's average power consumption
- Harmonics (DC-50th order) and Total harmonic distortion (THD) can be measured
- Saving measured data directly to external USB memory
- Measurement values can be saved as images or numerical data, and can be pasted into reports, analyzed in spreadsheet software, or used in a variety of other ways
- Easy setup with arrow keys
- GP-IB, USB and Ethernet communication are available

Model Number and Suffix Codes

Model	Suffix Codes	Description
760201		WT500 1 input element model
760202		WT500 2 input elements model
760203		WT500 3 input elements model
Power cord	-D	UL/CSA standard
	-F	VDE standard
	-R	SAA standard
	-Q	BS standard
	-H	GB standard
	-N	Brazilian standard
	-T	Taiwanese standard
Options	/C1	GP-IB interface
	/C7	Ethernet interface
	/EX1	External sensor input for 760201
	/EX2	External sensor input for 760202
	/EX3	External sensor input for 760203
	/G5	Harmonic Measurement
	/DT	Delta computation (760202/03 only)
	/FQ	Add-on Frequency Measurement (760202/03 only)
/V1	VGA Output	

Precision Power Analyzer **WT5000**

Basic power accuracy of ±0.03% & 7 input elements - to achieve higher accuracy power measurement



Towards the realization of a sustainable society, renewable energy such as solar/wind power generation is promoted globally and the development of EVs, PHVs, and their infrastructure systems is accelerating. WT5000 is a high precision power analyzer with drastically improved performance and functions to support further electric power saving and higher efficiency design of those devices and equipment.

Specifications

- Voltage ranges:
1.5/3/6/10/15/30/60/100/150/300/600/1000 V
- Current ranges (Direct input):
0.5/1/2/5/10/20/30 A (760901)
5 m/10 m/20 m/50 m/100 m/200 m/500 m/1/2/5 A (760902)
- Current ranges (External current sensor input):
50 m/100 m/200 m/500 m/1/2/5/10 V
- Measurement bandwidth (Power): DC, 0.1 Hz to 1 MHz
- Basic power accuracy (45 Hz to 66 Hz):
± (0.01% of reading + 0.02% of range)
- DC power accuracy:
± (0.02% of reading + 0.05% of range)
- Date update rate: 50 m/100 m/200 m/500 m/1/2/5/10/20 s
- Effect of Power factor: ±0.02% of S
(S: Apparent power at cos φ = 0)
- A/D converter
Sample rate: Up to 10 MS/s
Resolution: 18 bits
- Display: 10.1 inch Color TFT (WXGA) Touch screen
- Communication I/F: Standard function
GP-IB, Ethernet (1000Base-T, VXI-11) and USB (3.0 USB-TMC)
- External dimensions: Approx. 426(W) × 177(H) × 469(D) mm
- Weight: Approx. 12.5 kg (Main frame without input element)

30 A and 5 A High Accuracy Elements (760901 and 760902) include LAZER source inside.

CLASS 1 LASER PRODUCT
クラス1レーザー製品
1类激光产品
(EN 60825-1:2014)
(IEC 60825-1:2007, GB 7247.1-2012)

Complies with 21 CFR 1040.10 and 1040.11 except for deviations pursuant to Laser Notice No.50, dated June 24, 2007
4-9-8 Myojin-cho, Hachioji-shi, Tokyo 192-8566, Japan

Features

The next-generation WT series that can flexibly respond to the ever-changing market needs with its world highest class accuracy, modular architecture and various filters.

- Excellent basic performance polished to details
Basic power accuracy: ± (0.01% of reading + 0.02% of range)
Measurement bandwidth: Voltage DC to 10 MHz, Current DC to 5 MHz
Capture a slight value change in various condition of motor drive
- Functions to support simultaneous, synchronized measurement of multi-input systems
Simultaneous power measurement of up to 7 inputs
Evaluation of up to 4 motors (optional)
WXGA LCD with touch screen
USB (3.0)/Ethernet/GP-IB communications (standard)
Up to 32 GB of non-volatile internal memory (optional)
- Improved measurement performance for inverters
Max. 10 MS/s & 18 bits AD converter equipped
Simultaneous dual harmonic measurement up to the 500th order (standard)
Harmonic analysis of fundamental waveform up to 300 kHz
High-accuracy simultaneous measurement of power parameters of an entire bandwidth and fundamental components
Various Line/Frequency filter functions for detail analysis



Model Number and Suffix Code

Model	Suffix Code	Descriptions
WT5000		Precision Power Analyzer
Language Menu	-HC	Chinese/English Menu
	-HE	English Menu
	-HG	German/English Menu
	-HJ	Japanese/English Menu
Power Cord	-B	Indian Standard
	-D	UL/CSA Standard, PSE Compliant
	-F	VDE/Korean Standard
	-H	Chinese Standard
	-N	Brazilian Standard
	-Q	BS Standard
	-R	Australian Standard
	-T	Taiwanese Standard
	-U	IEC Plug Type B
Option	/M1	32 GB Built-in Memory
	/MTR1	Motor Evaluation 1
	/DA20*	20 CH D/A Output
	/MTR2*	Motor Evaluation 2
	/DS	Data Streaming
	/G7	IEC Harmonic/Flicker Measurement

*When select from these options, please select only one. /MTR2 option requires installation of /MTR1 option.

Model	Suffix Code	Descriptions
760901		30 A High Accuracy Element
760902		5 A High Accuracy Element

Standard accessories
 WT5000: Power cord, Rubber feet, Cover panel B8216JA 7 sets, User's manual, expanded user's manual, communication interface user's manual, connector (provided only with/DA20),
 760901/760902: Safety terminal adapter B9317WB/B9317WC (provided two adapters in a set times input element number) Safety terminal adapter A1650JZ/A1651JZ (provided black/red two adapters in a set, times of 30 A input element number), Safety terminal adapter B8213YA/B8213YB (provided black/red two adapters in a set, times of 5 A input element number)

When need above standard accessories additionally, order accessory products, 758931, 761951 and 761953. See Accessory list (P.39).

Electric Vehicle development

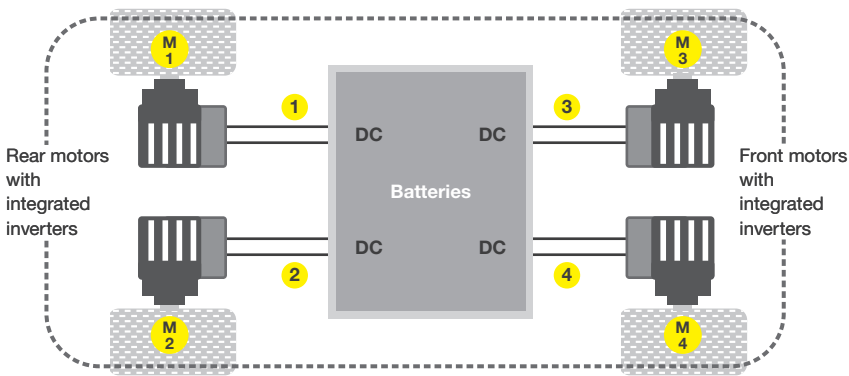

Case1: Modern drive systems with integrated inverters do not allow access to the AC signals. Here one of the main measurement tasks is to measure the overall drive train efficiency from DC to mechanical power. The example shows 4 DC measurements (1 to 4) with the corresponding 4 mechanical power measurements (M1 to M4)

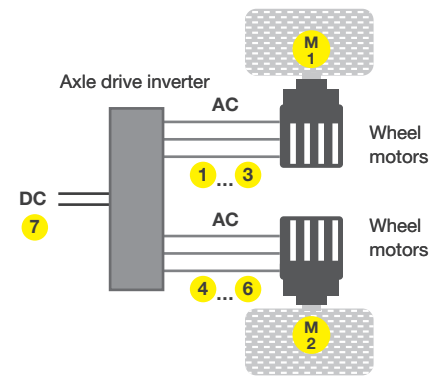

Case2: Example of an axle power efficiency measurement from DC (7) to dual 3-phase AC (1 to 3 and 4 to 6) plus dual mechanical power (M1 and M2)

Overview

Between 16 to 18% of the total charge of an electric car is consumed by electric drive system losses. Electric and hybrid car manufacturers therefore need to accurately evaluate motor and inverter control in order to achieve higher precision and greater efficiency.

Key requirements

- Multi-phase measurements from battery, inverter and motor
- Evaluation of motor characteristics such as torque, rotation speed and direction, slip and electrical angle
- Battery charging/discharging characteristics
- Harmonic analysis of inverter signals at various rotation speeds

Synchronous measurement of accurate power values and high-speed sampling waveform

In addition to benefitting from the highly accurate numerical data measured by the WT5000, one can stream to a PC the waveform data with a sample speed of up to 2 MS/s. Voltage and current waveforms as well as the motor signals can be streamed to a PC. This allows engineers to study the transient behavior simultaneously when measuring efficiency or energy consumption.

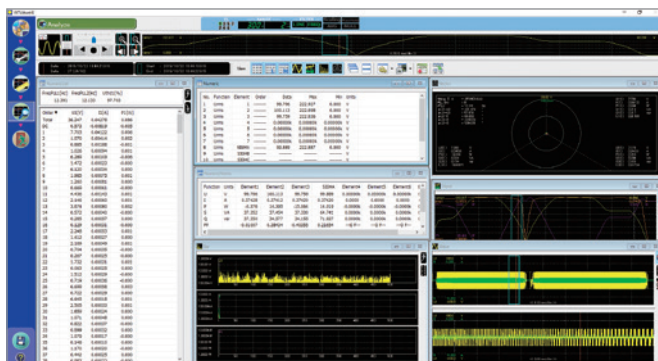

Display examples of WTViewerE

The WT5000 advantage

With high accuracy, multi-channel power measurements, evaluation of up to 4 motors and harmonic comparison capabilities, the WT5000 supports automotive engineers improve conversion efficiency, shorten charging times and improve driving range.

- Guaranteed accuracy in multichannel measurements
- Motor evaluation and mechatronic efficiency
- Battery charging & discharging characteristics
- Harmonics Analysis & comparisons

Harmonic limits compliance test for EV/PHV charging

Combined with the /G7 option and the Harmonic /Flicker measurement software, the WT5000 measured harmonic data can be saved into a PC and judge the level according to IEC regulations. To support large equipment over 16 A/phase (IEC61000-3-12), the CT200 current sensor model can be used.

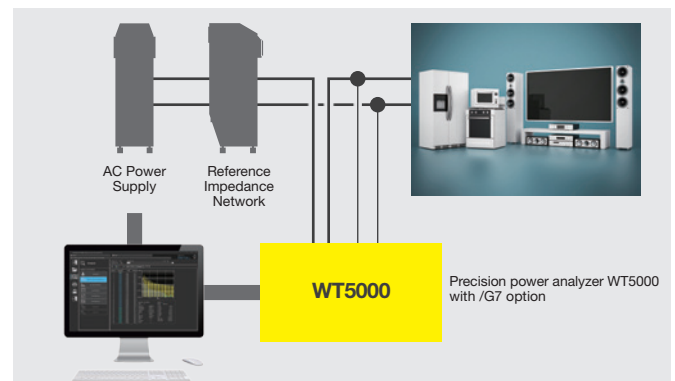

Precision power analyzer WT5000 with /G7 option

High Performance Power Analyzer **WT1800E**

Broad Ranges Power Measurement with One Unit



WT1800E
Bulletin WT1800E-01EN



Overview

The WT1800E High performance power analyzer can measure both the small currents of products called energy saving designed as well as the large currents involved in large-sized loads. As it handles voltages ranging from 1.5 V to 1000 V, it has a wide variety of uses. Since 3 phase power can be input from two separate systems (6 inputs), you only need one WT1800E to simultaneously measure Input/Output signals from inverters with normal/harmonics data as fast as 50 ms.

- Basic Power Accuracy ±0.1% of total
- DC Power Accuracy ±0.1% of total
- Voltage/Current Bandwidth 5 MHz (-3 dB, typical)
Voltage, 5 A direct input, external sensor input
- Sampling Rate 2 MS/s (16-bit resolution)
- Input Element number Max. 6
- Current Measurement 100 µA to 55 Arms direct

Motor and Drive Testing

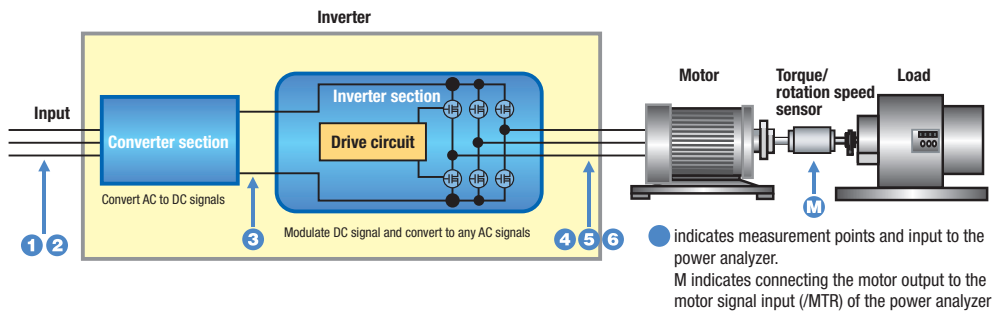

Advantages of WT1800E

Wide bandwidth and High speed sampling

The WT1800E is capable of 16-bit high resolution and 2 MHz sampling making it possible to measure faster signals with higher precision.

Motor evaluation: Electrical angle/rotation/direction

Measure rotation speed, torque, and output (mechanical power) of motors from analog/pulse inputs of rotation or torque sensors.

Harmonics and dual harmonics

Simultaneously measure distortion factors like THD, fundamental and harmonic components. Harmonics up to the 500th order can be measured even at 50 ms data update rate. Users can also measure harmonics on two different sources simultaneously.

Line filter to remove high frequency components

In the power evaluation of inverter waveforms, measurement values are affected by high frequency components. A digital filter function makes it possible to remove unnecessary high frequency components superimposed on signals. The filter can be independently set for each input element. An analog filter for 1 MHz/300 kHz, and a digital filter that can be set from 100 Hz to 100 kHz in increments of 100 Hz are available as standard.

DC power supply for AC/DC current sensors (/PD2 option)

The WT1800E can be equipped with a DC power supply for the CT series of AC/DC current sensors. By using dedicated connection cables and shunt resistors, the WT1800E can measure large currents. Improved S/N ratio and noise immunity is achieved by connecting the sensors in this way.

*/EX1 to /EX6 options must be installed in the WT1800E to be able to use the Shunt Resistor Box.



Inverter/ Converter Testing for Renewable Energy

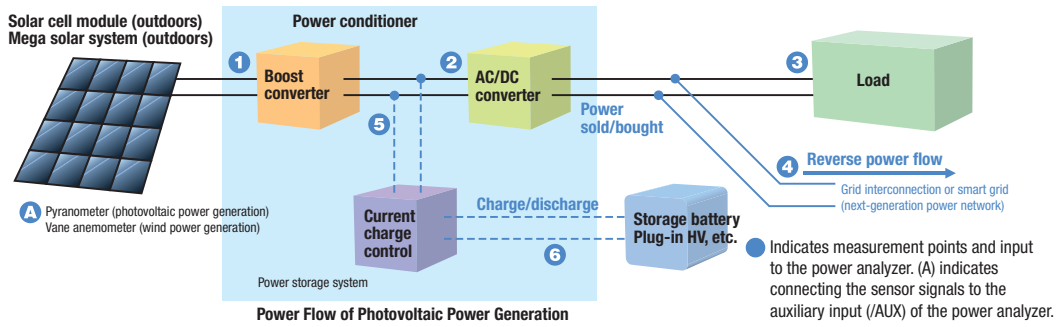

Digital Power Analyzers

Advantages of WT1800E

Multiple channels and wide input range

Evaluate Power conditioner efficiency using 6 input channels for simultaneous measurements from the inputs and outputs of boost converter, inverter, and storage battery. Direct input terminals (voltage range: 1.5 V to 1000 V and current range: 10 mA to 5 A or 1 A to 50 A) make it possible to perform high-precision measurements without using a current sensor. In addition, two units can be operated in synchronization for multi-channel power evaluation.

Measuring instantaneous peak power

In photovoltaic power generation, an MPPT control varies the voltage to maximize energy harvested from the solar panel. The WT1800E is capable of measuring not only the voltage, current, and power but also the voltage, current, and power peak values for both plus (+) and minus (-) sides.

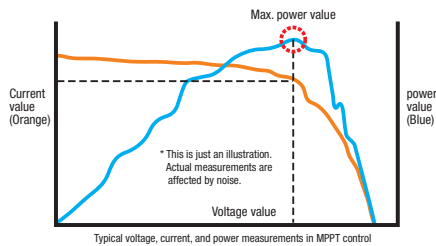

Basic Specifications

- Measurement Voltage range: (for Crest factor 3)
1.5/3/6/10/15/30/60/100/150/300/600/1000 V
- Measurement Direct Current range: (for Crest factor 3)
5 A input element
10 m/20 m/50 m/100 m/200 m/500 m/1/2/5 A
50 A input element
1/2/5/10/20/50 A
- Measurement External Current Sensor range: (for Crest Factor 3)
50 m/100 m/200 m/500 m/1/2/5/10 V
- Band width: DC, 0.1 Hz to 1 MHz
(5 A direct Current input, External Current Sensor input)
DC, 0.1 Hz to 200 kHz (50 A direct Current input)
- Basic Accuracy: (45 Hz ≤ f ≤ 66 Hz)
±(0.05% of reading + 0.05% of range)
- DC Accuracy: ±(0.05% of reading + 0.05% of range)
- A/D converter: Sampling frequency 2 MS/s
Resolution 16 bit
- External dimensions: Approx. 426 (W) × 177 (H) × 459 (D) mm
Approx. 426 (W) × 221 (H) × 459 (D) mm
(with /PD2 option)
- Weight: Approx. 15 kg (with 6-input element)

*5 A and 50 A Input Element can be installed in one unit

Model Number and Suffix Code

Model	Suffix Code	Description
One input element model		
WT1801E	-5A0-50A1	50 A × 1 Input Element
	-5A1-50A0	5 A × 1 Input Element
Two input elements model		
WT1802E	-5A0-50A2	50 A × 2 Input Elements
	-5A1-50A1	5 A × 1 Input Element 50 A × 1 Input Element
	-5A2-50A0	5 A × 2 Input Elements
Three input elements model		
WT1803E	-5A0-50A3	50 A × 3 Input Elements
	-5A1-50A2	5 A × 1 Input Element 50 A × 2 Input Elements
	-5A2-50A1	5 A × 2 Input Elements 50 A × 1 Input Element
	-5A3-50A0	5 A × 3 Input Elements
Four input elements model		
WT1804E	-5A0-50A4	50 A × 4 Input Elements
	-5A1-50A3	5 A × 1 Input Element 50 A × 3 Input Elements
	-5A2-50A2	5 A × 2 Input Elements 50 A × 2 Input Elements
	-5A3-50A1	5 A × 3 Input Elements 50 A × 1 Input Element
	-5A4-50A0	5 A × 4 Input Elements
Five input elements model		
WT1805E	-5A0-50A5	50 A × 5 Input Elements
	-5A1-50A4	5 A × 1 Input Element 50 A × 4 Input Elements
	-5A2-50A3	5 A × 2 Input Elements 50 A × 3 Input Elements
	-5A3-50A2	5 A × 3 Input Elements 50 A × 2 Input Elements
	-5A4-50A1	5 A × 4 Input Elements 50 A × 1 Input Element
	-5A5-50A0	5 A × 5 Input Elements
Six input elements model		
WT1806E	-5A0-50A6	50 A × 6 Input Elements
	-5A1-50A5	5 A × 1 Input Element 50 A × 5 Input Elements
	-5A2-50A4	5 A × 2 Input Elements 50 A × 4 Input Elements
	-5A3-50A3	5 A × 3 Input Elements 50 A × 3 Input Elements
	-5A4-50A2	5 A × 4 Input Elements 50 A × 2 Input Elements
	-5A5-50A1	5 A × 5 Input Elements 50 A × 1 Input Element
	-5A6-50A0	5 A × 6 Input Elements
Standard Options		
Menu Language	-HC	Chinese/English
	-HE	English/Japanese
	-HG	German/English
	-HR	Russian/English
Power Cord	-D	UL/CSA Standard PSE compliant
	-F	VDE Standard
	-H	GB Standard
	-N	NBR Standard
	-Q	BS Standard
	-R	AS Standard
	-T	Taiwanese Standard
Additional Options		
Option	/EX1 ^{*1}	External Current Sensor Input for WT1801E
	/EX2 ^{*1}	External Current Sensor input for WT1802E
	/EX3 ^{*1}	External Current Sensor Input for WT1803E
	/EX4 ^{*1}	External Current Sensor Input for WT1804E
	/EX5 ^{*1}	External Current Sensor Input for WT1805E
	/EX6 ^{*1}	External Current Sensor Input for WT1806E
	/B5	Built-in Printer
	/G5 ^{*2}	Harmonic Measurement
	/G6 ^{*2}	Simultaneous Dual Harmonics (except for WT1801E)
	/V1	RGB Output
	/DA	20-Channel D/A Output
	/MTR ^{*3}	Motor Evaluation Function
	/AUX ^{*3}	2-Channel Auxiliary Input
	/PD2 ^{*4}	6-Channel Current Sensor Power

*1, *4: When use Shunt Resistor Box for measurement, both /EX1 to /EX6 and /PD2 options are required. *2, *3: When select these functions, please specify only one. *4: /PD2 option requires Firmware version Ver. 3.1 or later.

Digital Power Meters **WT300E Series**

Compact WT300E series for reliable power measurement

Useful in the development of home appliances and office equipment as well as in the measurement of power consumption and standby power on production line



The WT300E series is the enhanced 5th generation of Yokogawa's compact power meter portfolio.

Specifications

- Direct voltage input range
15/30/60/150/300/600 V
- Direct current input range
5/10/20/50/100/200 mA (WT310E only)
0.5/1/2/5/10/20 A (Common for WT300E series)
1/2/5/10/20/40 A (WT310EH only)
- External sensor input range (optional)
2.5/5/10 V or 50 m/100 m/200 m/500 m/1/2 V
- Frequency range: DC, 0.1 Hz to 100 kHz
(up to 20 kHz for WT310EH)
- Basic accuracy (45 Hz to 66 Hz)
Voltage/current $\pm(0.1\% \text{ of rdg}^{*1} + 0.05\% \text{ of rng}^{*2})$
Power $\pm(0.1\% \text{ of rdg}^{*1} + 0.05\% \text{ of rng}^{*2})$
- Influence of power factor (when $\cos \phi = 0$)
Add $\pm 0.1\%$ of S
- Data update rate: 100 m/250 m/500 m/1/2/5/10/20 s, Auto
- External dimensions
· WT310E/WT310EH: Approx. 213(W) × 88(H) × 379(D) mm
(excluding protrusions)
· WT332E/WT333E: Approx. 213(W) × 132(H) × 379(D) mm
(excluding protrusions)
- Weight: Approx. 3.0 kg (WT310E/WT310EH), approx. 5.0 kg (WT332E/WT333E)

*1 rdg: reading, *2 rng: range

New Functions to Improve Measurement Efficiency

Range skip (range configuration) function

The WT300E series is equipped with the range skip (range configuration) function of the high-end models, which reduces the range-change time in auto-ranging mode that is long due to the wide voltage and current ranges. This function skips the ranges other than the pre-selected range to speed up the change to the selected range in auto-ranging mode. (The included WTViewerFreePlus software is required for the setting)

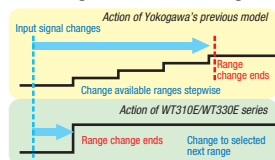

Integration measurement auto-ranging function

This is the industry's first function to automatically change the range in response to changes of the consumption power and current values in integration mode. This function continues integration even if the level of the input exceeds the maximum of the selected range and the range is changed to a higher level as a result of a rapid change in the conditions. This function eliminates the need for repeating the test even if a range is exceeded, thus reducing the evaluation time. Furthermore, separate power integration for each polarity ($\pm Wh$), current integration (Ah), and DC integration (charge/discharge) are also available. (The measurement accuracy depends on the input level and variation. It is recommended to set a fast data update rate.)

Features

- **Basic power accuracy: $\pm 0.15\%$ of total**
- **Measurement frequency range: DC, 0.1 Hz to 100 kHz (to 20 kHz for WT310EH)**
- **Fast data update rate: 100 ms**
- **Auto data update rate function for fluctuating input**
- **Small current measurement: 5 mA range (WT310E)**
- **40 A large current range (WT310EH)**
- **Multiple communication interfaces: USB, GP-IB or RS-232 and Ethernet (option and supports the Modbus/TCP Protocol)**
 - Integration energy measurement with auto ranging function
 - Simultaneous harmonics measurement of voltage, current, and power (mode switching is not required, but the included PC software is required)
 - Compact half-rack mount size
 - The included standard PC software allows you to display values, harmonic bar graph, and waveforms

Models and Suffix Codes

Model	Suffix Code	Description
WT310E		1 Input element model
Communication Interface	-C1	GP- IB
	-C2	RS- 232
Power Cord	-D	UL, CSA standard, PSE
	-F	VDE standard
	-R	AS standard
	-Q	BS standard
	-H	GB standard
	-N	NBR standard
	-T	Taiwanese standard
	/C7	Ethernet interface
Optional function	/EX1	External sensor input 2.5 V/5 V/10 V
	/EX2	External sensor input 50 mV/100 mV/200 mV/500 mV/1 V/2 V
	/G5	Harmonics Measurement
	/DA4	D/A output (4 CH)
Model	Suffix Code	Describe
WT310EH		1 Input element /High current model
Communication Interface	-C1	GP- IB
	-C2	RS- 232
Power Cord	-D	UL, CSA standard, PSE
	-F	VDE standard
	-R	AS standard
	-Q	BS standard
	-H	GB standard
	-N	NBR standard
	-T	Taiwanese standard
	/C7	Ethernet interface
Optional function	/EX1	External sensor input 2.5 V/5 V/10 V
	/EX2	External sensor input 50 mV/100 mV/200 mV/500 mV/1 V/2 V
	/G5	Harmonics Measurement
	/DA4	D/A output (4 CH)
Model	Suffix Code	Describe
WT332E		2 Input elements model
WT333E		3 Input elements model
Communication Interface	-C1	GP- IB
	-C2	RS- 232
Power Cord	-D	UL, CSA standard, PSE
	-F	VDE standard
	-R	AS standard
	-Q	BS standard
	-H	GB standard
	-N	NBR standard
	-T	Taiwanese standard
	/C7	Ethernet interface
Optional function	/EX1	External sensor input 2.5 V/5 V/10 V
	/EX2	External sensor input 50 mV/100 mV/200 mV/500 mV/1 V/2 V
	/G5	Harmonics Measurement
	/DA12	D/A output (12 CH)

Standard accessories
Power cord (1 set), Rubber foot (1 set), Current input protective cover (each 1 set), Start up guide (1 set), Connector (provided only with /DA4 or /DA12, each 1 set), Safety terminal adapter 758931 (provided two adapters in a set times input element number), CD (1 piece, included the startup guide, user guide, instruction manual and the communication manual by PDF data, and Viewer Software)

WTViewerFreePlus For WT300E series (included)

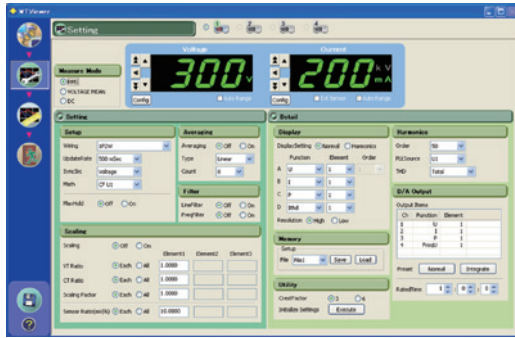

Setting Window

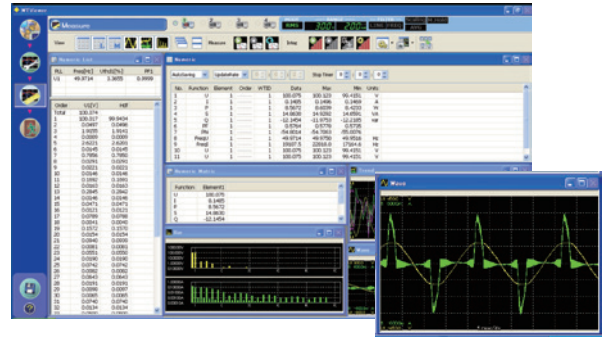

Measurement Window

The WTViewerFreePlus software installed on a PC uses a USB, GP-IB/RS-232, or Ethernet (optional) interface to capture, transfer, and display* five or more numeric values, bar graph of harmonic order components, trend graph of measurement data, or voltage/current waveforms that cannot be displayed on the LED display of the WT300E series. The use of this software extends the application range of the WT300E series.

With the aim of simplifying the connection and setup, the details were redesigned so that the communication function is recognized automatically, a dedicated setting window was added, and all measurement data can be displayed simultaneously.

* Waveform display requires the /G5 harmonic measurement option.

WT300E series can be used for a Variety of Applications

Production line or QA testing of electric Devices

- Compact half rack mount size helps customers build smaller test systems with a better Return on Investment (ROI).
- D/A output function and Modbus/TCP Protocol (/C7 option) for data recording
- Multiple communication interfaces. USB, RS-232 or GP-IB and Ethernet capability

The simultaneous measurement of power consumption parameters such as U, I, P, frequency, Power Factor and Harmonics for production line or QA testing results in reduced tact times. Thus testing is faster and cheaper. The DA output and communication interfaces enable data to be remotely and flexibly captured.

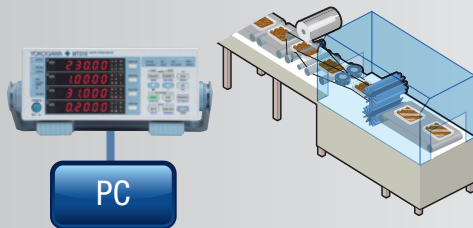

Duration testing and efficiency measurement for industrial motors and rotating machinery

- Integration measurement for long period
- D/A output function and Modbus/TCP Protocol (/C7 option) for data recording
- DC, 0.1 Hz to 100 kHz broad bandwidth capability

The WT300E series provides reliable current integration (Ah) and Energy (Wh) measurement for up to 10,000 hours (approx. 1 year). The D/A option is used to save and monitor the measurement results (WT310E/WT310EH: 4 ch, WT332E/WT333E: 12 ch). An external recorder or data logger like, a ScopeCorder, can be used to save this D/A function data along with other parameters such as temperatures, torque and rotation speed.

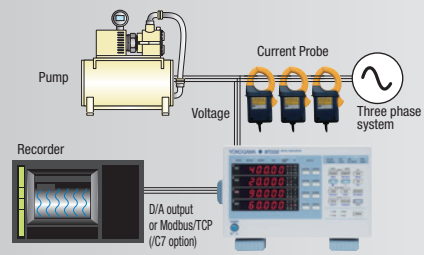

Comparison between WT210/230 series, WT300 series and WT300E series

	WT300E series	WT300 series	WT210/WT230
Basic power measurement accuracy (50/60 Hz)	0.1% of reading + 0.05% of range	0.1% of reading + 0.1% of range	0.1% of reading + 0.1% of range
Influence of power factor	When power factor (λ) = 0 (S: apparent power) ±0.1% of S for 45 Hz ≤ f ≤ 66 Hz	When power factor (λ) = 0 (S: apparent power) ±0.2% of S for 45 Hz ≤ f ≤ 66 Hz	When power factor (λ) = 0 (S: apparent power) ±0.2% of S for 45 Hz ≤ f ≤ 66 Hz
Frequency bandwidth	DC, 0.1 Hz to 100 kHz (WT310EH DC, 0.1 Hz to 20 kHz)	DC, 0.5 Hz to 100 kHz (WT310HC DC, 0.5 Hz to 20 kHz)	DC, 0.5 Hz to 100 kHz
Direct input Current range	WT310E: 12 ranges/5 mA to 20 A, WT310EH: 6 ranges/1 to 40 A, WT332E/WT333E: 6 ranges/0.5 to 20 A	WT310: 12 ranges/5 mA to 20 A, WT310HC: 6 ranges/1 to 40 A, WT332/WT333: 6 ranges/0.5 to 20 A	WT210: 12 ranges/5 mA to 20 A, WT230-2ch/WT230-3ch: 6 ranges/0.5 to 20 A
External current input	EX1: 2.5/5/10 [V] EX2: 50 m/100 m/200 m/500 m/1/2 [V] (OP.)	EX1: 2.5/5/10 [V] EX2: 50 m/100 m/200 m/500 m/1/2 [V] (OP.)	EX1: 2.5/5/10 [V] EX2: 50 m/100 m/200 m [V] (OP.)
Expansion of effective input range for voltage & current (CF = 6A)	2% to 260% ¹	No	No
Expansion of maximum displaying value for voltage & current (CF = 6A)	2% to 280% ²	No	No
Simultaneous measurement of RMS, Voltage MEAN & DC	Yes ³	Yes ³	No
Frequency measurement	2 channels (voltage and current)	2 channels (voltage and current)	selected voltage or current (one)
Number of display item	4 items	4 items	3 items
Sampling rate	Approximately 100 kS/s	Approximately 100 kS/s	Approximately 50 kS/s
Data Update rate	100 m/250 m/500 m/1/2/5/10/20 sec. Auto	100 m/250 m/500 m/1/2/5 sec	100 m/250 m/500 m/1/2/5 sec
Harmonic measurement	Yes (OP./G5)	Yes (OP./G5)	Yes (OP./HRM)
THD calculation maximum order setting	Yes (OP., 1 to 50th)	Yes (OP., 1 to 50th)	No
Auto ranging of integration	Yes	Yes	No
USB	Yes	Yes	No
GP-IB	Yes GP-IB or RS-232	Yes GP-IB or RS-232	Yes (OP) GP-IB or RS-232C
RS-232	Yes GP-IB or RS-232	Yes GP-IB or RS-232	Yes (OP) GP-IB or RS-232C
Ethernet	Yes (OP)	Yes (OP)	No
Modbus/TCP (Ethernet)	Yes (OP./C7)	No	No
IEEE standard for GP-IB	IEEE488.2	IEEE488.2	IEEE488.1 and IEEE488.2
Comparator function	Yes	Yes	Yes
Viewer software (setting & data capturing)	Free (included)	Free (included)	Free (download)

¹: WT310EH input range is 2% to 260% (20 A range only up to 200%)
²: WT310EH input range is 2% to 280% (20 A range only up to 220%)
³: Simultaneous, mode independent measurement using the WTViewerFreePlus PC software.

⁴A command compatible mode for the previous WT200 series is prepared. (IEEE488.2 only)
 In that mode, the WT300E series and WT300 series works identically to a WT200 series except for the Store (and recall operation) and the Compare functions.
⁵Modbus/TCP communication requires /C7 Ethernet option.

Precision Power Scope PX8000

Power Analyzer Capable of Measuring Waveform Parameters and Transient Power



PX8000
Bulletin PX8000-01EN



The PX8000 is a compact sophisticated power analyzer that can incorporate up to four measurement power elements. It can calculate the transient voltage, current, and power for each cycle, the average voltage, current, and power between cursors, and measure waveform parameters.

Features

- High-speed sampling and wide range measurement
The power of devices driven at a high frequency can be measured at a 100 MS/s sampling rate, at a 12-bit resolution, and in the 20 MHz range*1.
 - Waveform measurement function
Instantaneous power waveforms can be displayed as standard in addition to voltage and current waveforms, and power changes can be observed directly.
Voltage, current, and power waveforms for each cycle can be calculated and numerical values can be displayed by cursor.
The average voltage, current, and power values in a specified period by the cursor can be calculated.
Acquisition memory is up to 100 M points per channel (when equipping the /M2 option), allowing for capturing and displaying detailed waveforms.
 - Waveform analysis function
Up to the 500th order harmonic components can be measured simultaneously (when installing the /G5 option).
2-channel FFT function is available as standard.
 - De-skew (phase compensation) function when using an external current sensor, etc. is available.
 - Motor characteristics can be evaluated (mechanical output calculation with torque and rotation speed input, as well as analog and pulse input).
- *1: Direct current input at 10 MHz (-3 dB typical)

Various functions to measure transient power*2

Simultaneous calculation and display of instantaneous power waveforms

The PX8000 calculates the instantaneous power waveform simultaneously with the voltage and current waveforms. The instantaneous waveform can be obtained as the product of the voltage and current waveforms that are sampled at the same time. This function is a standard function so no special setting is required. This instantaneous power value can be displayed using the cursor.

Waveform data in the displayed entire range can be displayed on the numerical display screen.

The instantaneous power waveform indicates the trend of power change. The value at any point in time can be displayed using the cursor.



Power calculation in a range specified by the cursor

The average numerical values in a range specified by the cursor can be calculated. Values between cursors of waveforms displayed on the screen can be displayed on the upper numerical display screen. The MEASURE function cursor can be used for the measurement in the specified range.

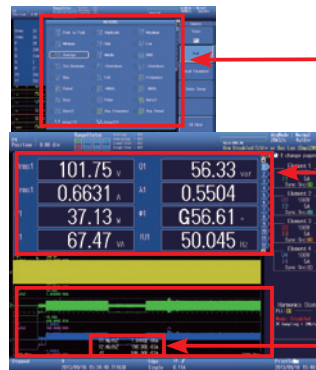

Waveform parameters to be calculated can be set in detail.

Measured values of waveforms displayed between cursors indicating the start and stop positions can be displayed on the numerical display screen.

Displaying result of automated measurement of waveform parameters.

Trend power calculation for each cycle

Power trend waveform for each cycle can be calculated using the User Defined Computation (waveform calculation, MATH) at up to 4 M points. The captured waveforms can be used to obtain the value for a particular cycle and calculate the difference between cycles using the cursor function.

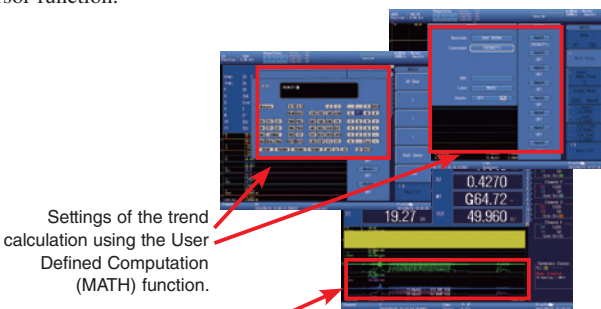

Settings of the trend calculation using the User Defined Computation (MATH) function.

The cursor (horizontal, vertical, and marker) allows you to display the numerical data of trend waveform for each cycle calculated using the User Defined Calculation (MATH).

Viewer software PowerViewerPlus

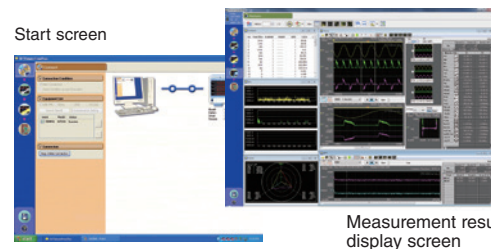

A PC application software for the PX8000, 760881 PowerViewerPlus allows you to transfer measurement data of the PX8000 to a PC to display and analyze a large amount of waveform data on the PC.

*2: Accuracy is not specified for the numerical data of the measured transient power.

Power measurement elements (voltage and current modules) and Auxiliary (AUX) module

Power measurement elements

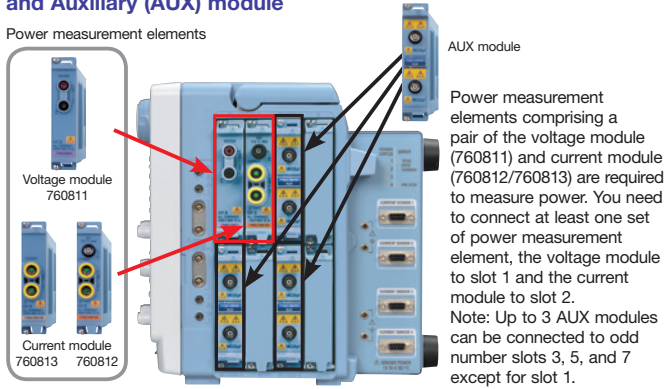

Functions to prevent mismatch between the voltage and current modules

- Warning message
- Check on the overview screen (you can check paired modules)



Safety design

Different types of voltage input terminal and current input terminal are used to keep the user from confusing one from the other.

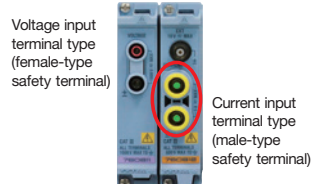

Specifications

- Voltage direct input range: 1.5/3/6/10/15/30/60/100/150/300/600/1000 Vrms
- Current direct input range: 10 m/20 m/50 m/100 m/200 m/500 m/1/2/5 Arms
- Current sensor input range: 50 m/100 m/200 m/500 m/1/2/5/10 Vrms
- Frequency range: DC to 20 MHz (-3 dB, voltage and current sensor input)
DC to 10 MHz (-3 dB, current direct input)
- Power basic accuracy (45 Hz to 66 Hz): ±(0.1% of reading + 0.1% of range)
- Influence of power factor error (cos φ = 0): ±0.15% of S (apparent power)
- A/D converter: Maximum sampling rate 100 MS/s
Resolution 12-bit
- Acquisition memory: Standard: 10 M points per channel
Max: 100 M points per channel (/M2 option)
- Maximum waveform viewing time: 20 minutes (not dependent on the memory size)
- History memory: This function can save up to 1000 records of waveform data and display and calculate them as needed (when the /M2 option installed)
- Waveform display: Up to 16 waveforms can be displayed. Voltage and current waveforms and simultaneous power waveform can be displayed.
- Snapshot: Waveform at an arbitrary moment on the screen can be saved.
- De-skew (phase compensation) function: Phase difference between the voltage and current modules is compensated.
- Trend measurement (waveform measurement, MATH): Voltage, current, and power waveform calculation for each cycle
- Calculation in the specified period (waveform parameter calculation, MEASURE): Average value between cursors can be measured.
- Simultaneous harmonic measurement: Up to the 500th order harmonic measurement (/G5 option)
- 2-channel FFT function available as standard
- Printer: Screens can be copied (/B5 option)
- External storage: USB port (x2), SD card
- Video output: RGB analog, video output
- Display unit: 10.4-inch color TFT XGA display
- GP-IB, Ethernet, and USB communication available as standard
- IRIG function: Data measured with multiple PX8000 units can be synchronized (/C20 option)
- Sensor power supply: 4CH DC power supply ±15Vdc Max. of 1.8A/CH
- External dimensions: 355 (W) × 259 (H) × 180 (D) mm (excluding protrusions)
- Weight: Approximately 6.5 kg (main unit only, excluding paper and options)

* For common options and accessories, see Model and Suffix codes.

Application example: Inverter evaluation using the PX8000 and DL950

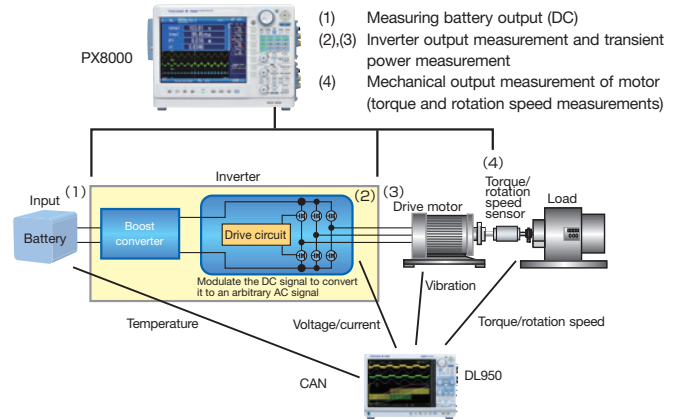

Overview of the evaluation with the PX8000 and DL950

Electric vehicles (EVs) and hybrid electric vehicles (HEV) are made of a large number of electrical and mechanical parts. To evaluate their efficiency, electrical parts and mechanical parts must be measured simultaneously. The DL950 is a data acquisition instrument that can measure many types of physical quantities at multiple points simultaneously. On the other hand, the PX8000 measures the efficiency of the inverter and the motor, as well as transient changes at every moment based on the electrical signals of voltage and current and the mechanical output calculated from the torque and rotation speed.

Model and Suffix Codes

Product name	Model	Suffix code	Description
Precision Power Scope	PX8000		Precision Power Scope main unit
		-D	UL and CSA standards (PSE compliant, 3-pole type)
		-F	VDE standard
		-R	AS standard
		-Q	BS standard
		-H	GB standard
		-N	NBR standard
		-HE	English menu language
		/B5	Built-in printer
		/C20	IRIG function
	/G5	Simultaneous harmonic measurement	
	/M1*1	50 M point/CH memory extension	
	/M2*1	100 M point/CH memory extension	
	/P4	4 CH probe power output	
	/PD2	4 CH sensor power output*2	

Product name	Model	Suffix code	Description
Voltage Module	760811	*3	Necessary to order the same number as that of the 760812/760813 Current Modules at the same time
Current Module	760812	*3	Necessary to order the same number of that of the 760811 Voltage Modules at the same time
	760813	*3	Necessary to order the same number of that of the 760811 Voltage Modules at the same time The 760813 is direct current input only
Auxiliary (AUX) Module	760851		Can measure the sensor signals of torque and rotation speed on 2 channels

*1 Selection of both /M1 and /M2 is not available for one main frame. The standard memory length is 10 M points/CH.

*2 When use Shunt resistor Box for measurement, /PD2 option and Current module 760812 are required. The /PD2 option requires Firmware version Ver 3.2 or later.

*3 The power value will be calibrated using a pair of Voltage (760811) and Current (760812/760813) modules, therefore an equal quantity of these must be ordered together.

Product name	Model	Suffix code	Description
Power Viewer Plus	760881		Dedicated PC application software for PX8000 It is a waveform data analysis software



Safety Precautions for Laser Products
The voltage module (760811), the current modules (760812/760813) and the AUX module (760851) uses laser light sources internally. These modules or respond to Class 1 laser product as defined in the IEC60825-1: 2007 Safety of Laser Products-Part 1: Equipment Classification and Requirements.

AC/DC Current Sensor **CT60/CT200/CT1000/CT1000A/CT2000A**

Wide Variety of precision Current Sensors for broad applications



Bulletin CT1000-00E



CT60/CT200/CT1000/CT1000A/CT2000A

AC/DC Current Sensors, DC, up to 800 kHz, up to 3000 A peak

Rated Current	
CT60	DC: 0 to 60 A, AC: 60 A peak
CT200	DC: 0 to 200 A, AC: 200 A peak
CT1000	DC: 0 to 1000 A, AC: 1000 A peak
CT1000A	DC: 0 to 1000 A, AC: 1000 Arms (1500 A peak)
CT2000A	DC: 0 to 2000 A, AC: 2000 Arms (3000 A peak)

Frequency bandwidth	
CT60	DC to 800 kHz (-3 dB)
CT200	DC to 500 kHz (-3 dB)
CT1000	DC to 300 kHz (-3 dB)
CT1000A	DC to 300 kHz (-3 dB)
CT2000A	DC to 40 kHz (-3 dB)

Measurement Accuracy
 DC, 50/60 Hz: $\pm (0.05\% \text{ of reading} + 30 \mu\text{A})$
 DC, 50/60 Hz: $\pm (0.04\% \text{ of reading} + 30 \mu\text{A})$ CT1000A only
 Power Supply Voltage $\pm (15 \text{ V} + 5\%)$

The WT1800E and the PX8000 provide a power supply (/PD2 option) for the CT-series current sensor. It's easy to connect with the dedicated cable.

Current Probe **751552**

Accessory for Digital Power Meters and Power Analyzer



Bulletin CT1000-00E

751552

Current Clamp-on Probe, AC 1000 Arms (1400 A Peak)

- Measurement bandwidth: 30 Hz to 5 kHz
- Basic accuracy: $\pm 0.3\%$ of reading
- Maximum allowable input: AC 1000 Arms
1400 Apk (AC)
- Current output type: 1 mA/A

To connect this probe to the WT series, you need the Model 758921 (Fork terminal adapter) and Model 758917 (Measurement lead set) accessories sold separately. For details, please see the Power Meter Accessories Catalog (Bulletin CT1000-00E).

Current Sensor Unit **751522/751524**

Accessories for Digital Power meters and Power Analyzers



751522 : For Single-Phase



751524 : For Three-Phase

Bulletin CT1000-00E

751522/751524

AC/DC Current Sensor Unit. DC, up to 100 kHz, up to 1000 A peak

- Large current measurement:
DC: 0 to 1000 A / AC: 1000 A peak
- Wide measurement frequency range:
DC to 100 kHz (-3 dB)
- High-precision fundamental accuracy:
 $\pm (0.05\% \text{ of rdg}^* + 40 \mu\text{A})$
- Superior noise withstanding ability and CMRR characteristic due to optimized casing design
- Calibration enabled in combination with WT Series

* rdg: reading

WT Series Accessory Software **761941 WtViewerE Application Software**

PC-based Control and Data Acquisition

WtViewerE

761941

Ideal for multichannel power measurements

The WtViewerE allows users to:

- Connect, synchronize and configure up to four WT units via Ethernet, USB, GPIB or RS232
- Remotely monitor, collect, and analyze live or stored multichannel measurements in a numeric, bar, trend, or vector formats
- Enables user defined computation such as efficiency with measured data from multiple units
- Save/load configuration and measurement data

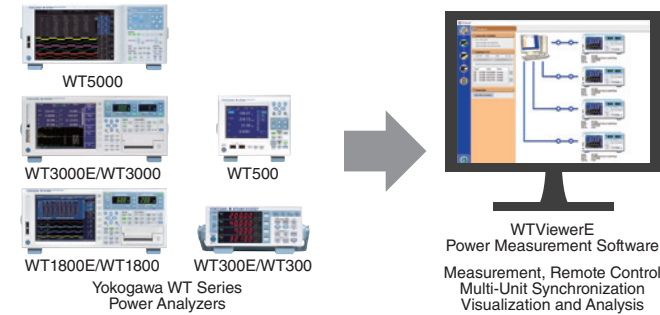

WtViewerE software enables PC connectivity for Yokogawa power analyzers such as the WT5000, WT3000E, WT1800E, WT500 and WT300E through Ethernet, USB, GPIB or RS232. This connectivity allows users to easily control, monitor, collect, analyze, and save measurements remotely.

To stream the waveform data to a PC, it is possible to make use of WtViewerE 761941. This can also be done by making use of dedicated communication commands for programming. (The data streaming function is not available in the free software of WtViewerEfree.)

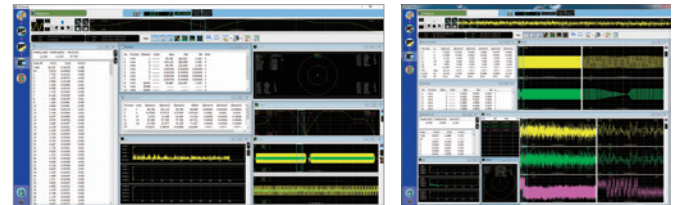

Display examples of WtViewerE

* WT5000 will be supported soon.

Overview of specifications

Compatible WT series model and permissible combinations for multi unit connections

Series model	Number of permissible connections	Model	Firmware version
WT3000E/WT3000 series	Up to 4 units from all 8 models	WT3001E/WT3002E/WT3003E/WT3004E	No restriction
		WT3000 (760301/760302/760303/760304) *	6.11 or later
WT1800E/WT1800 series	Up to 4 units from all 12 models	WT1801E/WT1802E/WT1803E/WT1804E/WT1805E/WT1806E	No restriction
		WT1801/WT1802/WT1803/WT1804/WT1805/WT1806*	2.31 or later
WT500 series	Up to 4 units from all 3 models	WT500 (760201/760202/760203)	1.21 or later
WT300E/WT300 series	Up to 4 units from all 8 models	WT310E/WT310EH/WT332E/WT333E	No restriction
		WT310/WT310HC/WT332/WT333*	No restriction

* discontinued products

Functions

Measuring items	Normal, Harmonics, Integration
Display screens	Numeric, Waveform ¹⁻⁴ , Trend, Harmonic list ² , Harmonic bar graph ² , Vector ²⁻³ and Analysis graph
Data acquisition interval	50 ms at maximum speed
Data conversion	Numeric and Waveform data: CSV format (.csv)

¹ Harmonic measurement option must be installed in the WT300 or WT300E.

² Harmonic measurement option must be installed in the WT.

³ A vector window cannot be displayed on the WT300 or WT300E.

⁴ When WT update interval is 1 second or longer and the WT waveform observation period is same as the update interval, measured waveform data can be acquired continuously. Continuous waveform data cannot be acquired from the WT300 or WT300E.

WT Series Accessory Software **Power Consumption Measurement Software**

Support for IEC62301 Standby Power Testing

Power Consumption Measurement Software

Free Software

- The IEC62301 Ed 2.0 is a reference standard in the EN 50564: 2011 Directive. This software corresponds to a test method of those two standards.
- Allows you to acquire the necessary data such as a power value with simple operations such as just pressing the Start button.
- Allows you to print out a report on the measurement results.

(The free software can be downloaded from Yokogawa's website)

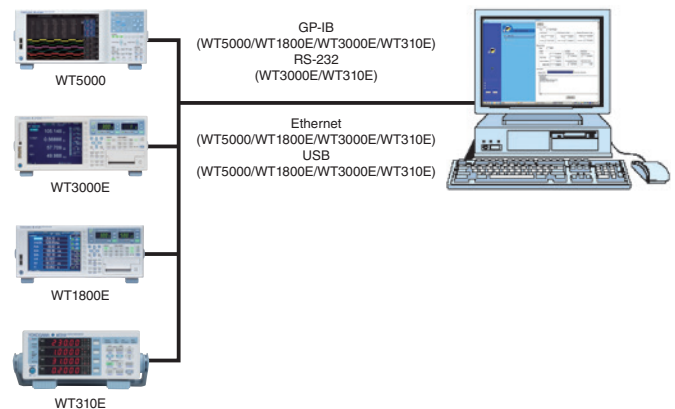
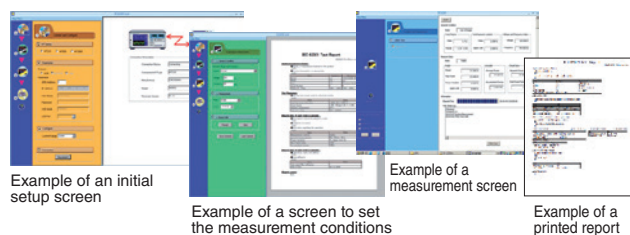

WT Series Accessory Software 761922 IEC regulation software

Support for IEC Standards Testing

Harmonic/Flicker Measurement Software

761922

- Allows you to judge high current equipment with input current of 16 A or more per phase (IEC61000-3-11/3-12).
- Support for the method that does not consider interharmonics in the window of 16 cycles specified in IEC61000-4-7
- Best-in-class high-precision current and voltage measurements (also allows you to calculate the limits of the standard)
- All Judgment graph display shows a list of all the measurement results in a time series by order.

- Allows you to measure harmonics for up to 24 hours, so capable of measuring equipment that needs more than one hour for one cycle.
- Continuous data acquisition at a measurement interval of 200 ms ensures continuous measurement over a long period of time with no missing data
- Support for the standard tests of single- and three-phase equipment



Launcher screen



Example of an initial setup screen

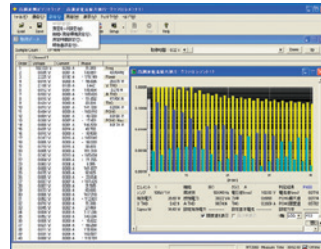

Example of a measurement screen

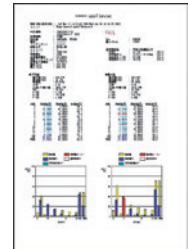

Example of a printed report

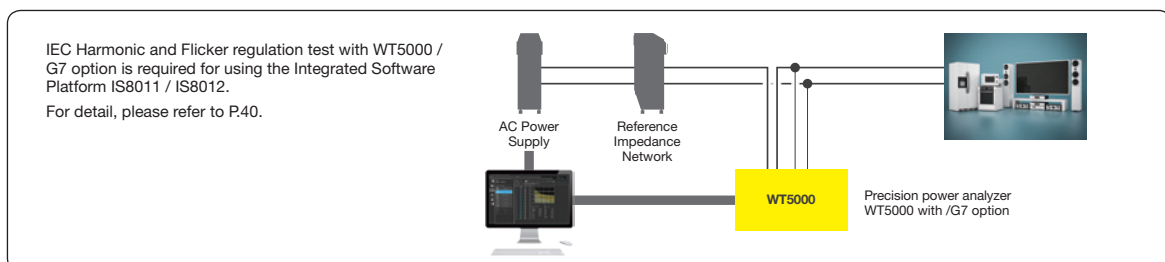
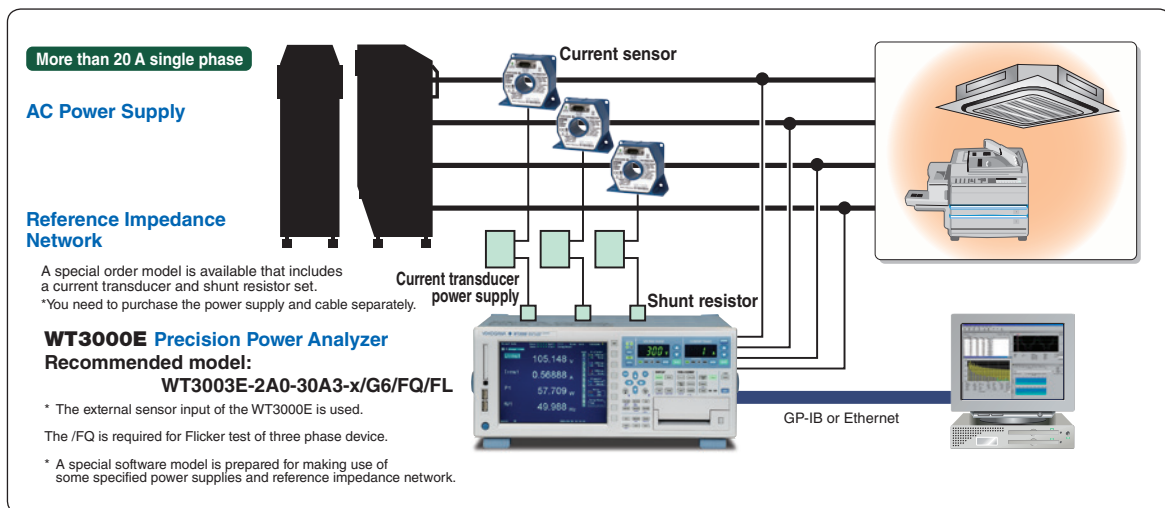
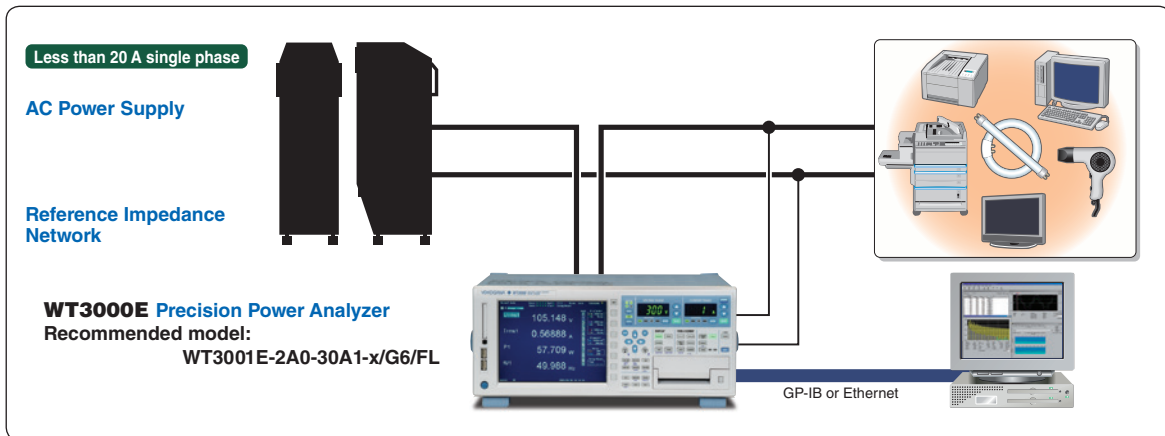

Digital Power Analyzers Accessories List **Accessories List**

Product	Part No.	Description	Image						
				WT5000	WT3000E	WT1800E	WT500	WT310E/WT330E	PX8000
1:1 BNC safety adapter lead	701901	1000 Vrms-CAT II, 1.8 m long Safety BNC (male) to safety banana (female) use in combination with 701959, 701954, 758921, 758922 or 758929		●	●	●	●	●	●
Measurement leads	758917	Two leads in a set. Use 758917 in combination with 758922 or 758929. Total length: 75 cm Rating: 1000 V, 32 A		●	●	●	●	●	●
Small alligator adapters	758922	For connection to measurement leads (758917). Two in a set. Rating: 300 V		●	●	●	●	●	●
Large alligator adapters	758929	For connection to measurement leads (758917). Two in a set. Rating: 1000 V		●	●	●	●	●	●
Safety terminal adapter set	758923	Spring-hold type. Two adapters in a set.		●	●	●	●	●	●
Safety terminal adapter set	758931	Screw-fastened adapters for voltage input. Two adapters in a set. 1.5 mm Allen wrench for tightening is required.		●	●	●	●	●	●
Safety terminal adapter set	761953	Screw-fastened adapters for current input of WT5000 and PX8000. Two adapters in a set. Allen wrench for tightening is required.		●					●
Safety terminal adapter set	761951	Screw-fastened adapters for large current input of WT5000. Two adapters in a set. Allen wrench for tightening is required.		●					
Fork terminal adapter	758921	Two adapters (red and black) to a set. Used when attaching banana plug to binding post.			●	●	●	●	
Conversion adapter	758924	For conversion between BNC and female banana plug		●	●	●	●	●	●
Conversion adapter	366971	9-pin/25-pin conversion adapter			●				
External sensor cable	B9284LK	For the external input of the WT series. Length: 50 cm		●	●	●	●	●	●
BNC cable	366924	BNC cable BNC-BNC, 1 m		●	●	●	●		
BNC cable	366925	BNC cable BNC-BNC, 2 m		●	●	●	●		
26 pin cable	705926	For/DA4 and/DA12 option						●	
Current sensor cable	A1559WL	Cable length 3 m for CT60/CT200/CT1000				●			●
Current sensor cable	A1560WL	Cable length 5 m for CT60/CT200/CT1000				●			●
Current sensor direct cable	A1589WL	Cable length 3 m (Burden resistor 2.7 ohm) for CT60/CT200/CT1000				●			●
Current sensor direct cable	A1628WL	Cable length 5 m (Without Burden resistor) for CT60/CT200/CT2000A				●			●
Shunt resistor box	A1323EZ	5 ohm ±0.05% for CT1000				●			●
Shunt resistor box	A1324EZ	10 ohm ±0.02% for CT1000, Max 640 A peak				●			●
Shunt resistor box	A1325EZ	20 ohm ±0.02% for CT200 and CT60				●			●
Rack mounting kit	751535-E4	For EIA			●	●			
Rack mounting kit	751535-J4	For JIS			●	●			
Rack mounting kit	751533-E2	For WT310E/WT310EH EIA standalone installation						●	
Rack mounting kit	751533-J2	For WT310E/WT310EH JIS standalone installation						●	
Rack mounting kit	751534-E2	For WT310E/WT310EH EIA connected installation						●	
Rack mounting kit	751534-J2	For WT310E/WT310EH JIS connected installation						●	
Rack mounting kit	751533-E3	For WT332E/WT333E EIA standalone installation						●	
Rack mounting kit	751533-J3	For WT332E/WT333E JIS standalone installation						●	
Rack mounting kit	751534-E3	For WT332E/WT333E EIA connected installation						●	
Rack mounting kit	751534-J3	For WT332E/WT333E JIS connected installation						●	
Rack mounting kit	751533-E4	For WT500 EIA standalone installation					●		
Rack mounting kit	751533-J4	For WT500 JIS standalone installation					●		
Rack mounting kit	751534-E4	For WT500 EIA connected installation					●		
Rack mounting kit	751534-J4	For WT500 JIS connected installation					●		
Rack mounting kit	751542-E4	For WT5000 EIA connected installation		●					
Rack mounting kit	751542-J4	For WT5000 JIS connected installation		●					

Integrated Software Platform **IS8000 Series**

Accelerate Product Engineering Workflow

Integrated Software Platform



The IS8000 software platform is an integrated solution that accelerates engineering workflow. It is a revolutionary platform that tightly integrates the timing, control, and data collection from multiple instruments, creating a comprehensive measurement suite that delivers confidence, efficiency, and unity.

Overview

High-speed waveform data streaming

In combination with the 10 Gb Ethernet interface option (C60 option) on the DL950 and the IS8000, up to eight channels of data can be stored in real time on a PC at a sampling rate of up to 10 M Sample/s.

Longer recording times are now possible for high-speed, multi-channel inputs such as gate signals and switching waveforms of multi-phase inverters.

In the absence of the C60 option, up to 16 channels of data can be stored in real time on a PC at a sampling rate of up to 200 k Sample/s.

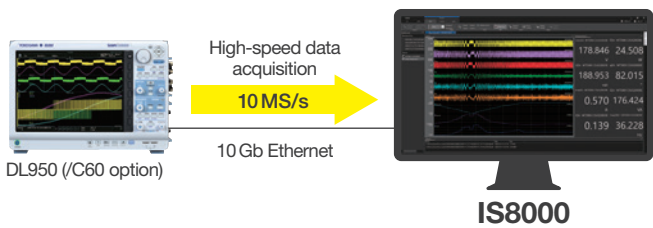

Multi-unit Monitoring with Time Synchronization

Accurate power and waveform data synchronization is available across multiple channels with minimal error. Data from the WT5000 power analyzer and DL950 ScopeCorder is time-correlated with less than 10 μ s error using IEEE1588 PTP technology. Precise power parameters and waveforms are displayed on the same time axis.

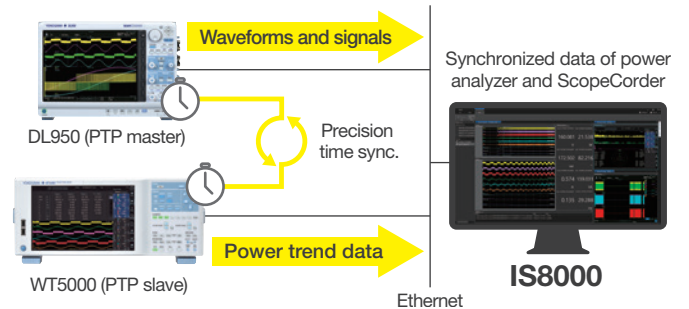

FFT and Math Function

Measure up to 16 Fast Fourier Transform (FFT) processes for a wealth of analysis functions for automatic calculation of frequency and integrated value and filter processing.

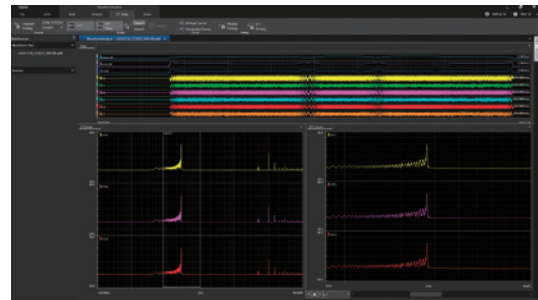

FFT Analysis window

File Import and Export

The IS8000 supports binary, ASCII, and the MDF format, a very common format for the automotive industry. Power, waveform and image data on the IS8000 can be shared with a development system or third-party software.

File Format	Import	Export
WDF (Binary)	✓	—
CSV (Ascii)	✓*1	✓
MDF (Binary)	✓*2	✓

*1 WT5000 data file *2 Data file recorded by IS8000

Device control	Measurement	Analysis	Export
Device Settings	High-speed Acquisition	Enhanced Viewer	Export to CSV
Remote Monitoring	Power & Waveform Sync.	FFT Analysis	Export to MDF
Connect to Multi units	High-Speed Cam. Sync.	Enhanced Math	Report Generator
IEC Harmonic/Flicker Test & Analysis			Standard functions of the software platform Add-on Functions Only available in IS8011/8012

Power of One

Unity Efficiency Synchronization Scalability



An Intuitive User Interface

- 1 Ribbon menu**
Format depends on which window is active.
- 2 Numeric display**
Numerical data from the WT5000 power analyzer can be displayed here.
- 3 Trend and waveform window**
Acquired data from single or multiple devices is displayed simultaneously.
- 4 Zoom/Pan window**
Up to four zoom regions can be defined and displayed simultaneously.
- 5 Remote control interface**
It works with the WT5000, DL350/850/950 and DLM3000/5000 series.
- 6 Recording file list**
Name, creation date and file size of the acquired data files are displayed here.
- 7 FFT Analysis (MH1 option required)**
Measure up to 16 FFT processes at the same time.
- 8 High-speed camera images (FS1 option required)**
IS8000 can synchronize high-speed video with acquired waveforms.

Integrated Software Platform

*This image has been partially processed.

Report Generator

Customized reports are easily created by dragging and dropping measurement data, waveforms, graphs, etc. onto the sheet.



RP1 option

Synchronize High-speed camera

IS8000 synchronizes high speed camera images with related current, voltage, and control signals. Simultaneous slow motion playback allows visualization between design and results.



FS1 option

Two license types

Subscription License

This license type is based on annual subscription renewal for the platform and optional features. Customers can purchase the software for as long as they need it, keeping their initial investment to a minimum.

Customers will always have the latest version of the software available for the duration of the subscription, so will always be able to use the latest features, standards and security.

Perpetual License

This is a one-time purchase and can be used indefinitely. Additional optional features can be purchased at a later date. The platform can be upgraded free of charge for up to five major software version revisions after purchase. After that, customers can continue to use the software in the same environment.

This license is suitable for customers who do not plan to change their equipment environment at the time of installation.

Model and Suffix code

IS8000 Integrated Software Platform

Model	Code	Description
IS8001		IS8000 Integrated Software Platform Subscription (Annual license)
IS8002		IS8000 Integrated Software Platform Perpetual (Permanent license)
	/SY1	Multi-Unit Synchronization Option
	/MH1	Waveform Math Option
	/RP1	Report Generator Option
	/FS1	High-speed Camera Synchronization Option

Add-on Packages

Model	Code	Description
IS8001EX		IS8000 Add-on Package Subscription (Annual license)
IS8002EX		IS8000 Add-on Package Perpetual (Permanent license)
	-SY1	Multi-Unit Synchronization
	-MH1	Waveform Math
	-RP1	Report Generator
	-FS1	High-speed Camera Synchronization

Optional software package for IEC Harmonic and Flicker compliance test

The IS8011/IS8012 optional software package is designed to perform harmonic and flicker tests in accordance with IEC61000-3-2, 3-3, 3-11 and 3-12 standards using the WT5000 precision power analyzer. Users can easily set the conditions and output the test report without any specialized knowledge.

Users can make a pass/fail judgment by class A, B, C, and D of the harmonic current measurement values.

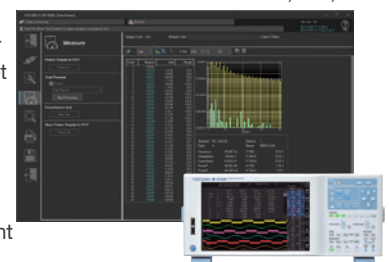

IS8010 IEC Harmonic/Flicker Measurement Software

Model	Code	Description
IS8011		IEC Harmonic/Flicker Software Subscription (Annual license)
IS8012		IEC Harmonic/Flicker Software Perpetual (Permanent license)

DC Voltage/Current Source **GS200**

Higher Accuracy — The New Advanced DC Voltage/Current Source



Functions

The GS200 generates high accuracy, high stability, high resolution, and extremely low-noise voltage and current signals that are required for many applications.

- Voltage source up to ± 32 V and current source up to ± 200 mA
- 5 1/2-digit, $\pm 120,000$ -count output resolution
- Voltage and current simple monitoring feature (optional)
- Programmable output up to 10,000 points
- Built-in USB mass storage device
- Channel expansion through synchronous operation

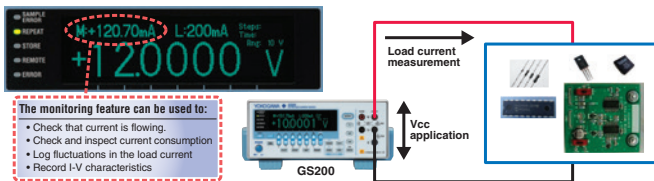

Voltage and Current Source Range

The GS200 can perform four-quadrant operation by operating as a current source or a current sink in the range of ± 30 V and ± 200 mA. When the GS200 is sinking current, it can operate over the exact same range as when it is operating as a current source. You can use the GS200 not just as a highly accurate voltage source but also as a highly accurate constant-current electronic load.

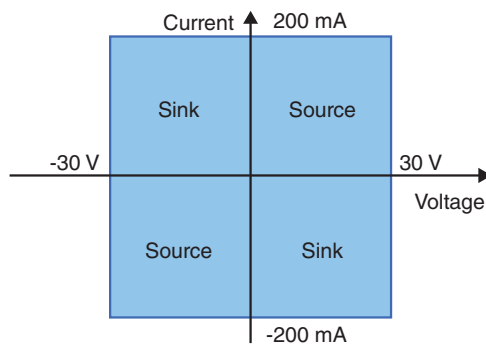

Functions and Specifications

■ Source

- Voltage source
 - Range : 10 mV, 100 mV, 1 V, 10 V, 30 V (Use a highly accurate voltage divider at 10 mV and 100 mV ranges)
 - Maximum output : ± 200 mA (at 1 V, 10 V, and 30 V ranges)
- Current source
 - Range : 1 mA, 10 mA, 100 mA, 200 mA
 - Maximum output : ± 30 V
- Program Feature
 - Maximum number of steps : 10,000
 - Trigger source : Internal timer (0.1s resolution), External, Step input, measurement end

■ Monitoring (option)

- Function : Voltage (during current generation), Current (during voltage generation)
- Integration time : 1 to 25 PLC (Power Line Cycle)
- Trigger source : Internal timer (0.1 s resolution), READY, Communication and Immediate
- Delay : 0 to 999,999 ms (1 ms resolution)
- Maximum storage : 10,000 points

■ External Input and Output

- Input signal : TRIG IN, OUTPUT IN
- Output signal : TRIG OUT, OUTPUT OUT, READY OUT
- Connector : RJ-11 connector
BNC connector (Select any one of the signals for both the input and output)

- Input and output level : TTL
- Minimum pulse width : 10 μ s

■ Interface

- GP-IB interface
- USB interface
- Ethernet interface (option) 100BASE-TX/10BASE-T

■ General Specifications

- Display : 256 \times 64 dot vacuum fluorescent display
- External dimensions: Approx. 213 (W) \times 88 (H) \times 350 (D) mm (excluding protrusions)
- Weight : Approx. 5 kg

Model and Suffix Codes

Model	Suffix Code	Description
GS210		DC voltage/current source (front panel output terminals)
GS211		DC voltage/current source (rear panel output terminals)
Supply voltage	-1	100 VAC, 50/60 Hz
	-4	120 VAC, 50/60 Hz
	-7	230 VAC, 50/60 Hz
Power cord	-D	UL/CSA standard
	-F	VDE standard
	-R	AS standard
	-Q	BS standard
	-H	GB standard
Options	/MON	Monitoring function
	/C10	Ethernet interface function

Multi Channel Source Measure Unit **GS820**

Highly Accurate 2-Channel Voltage/Current Source Measure Unit

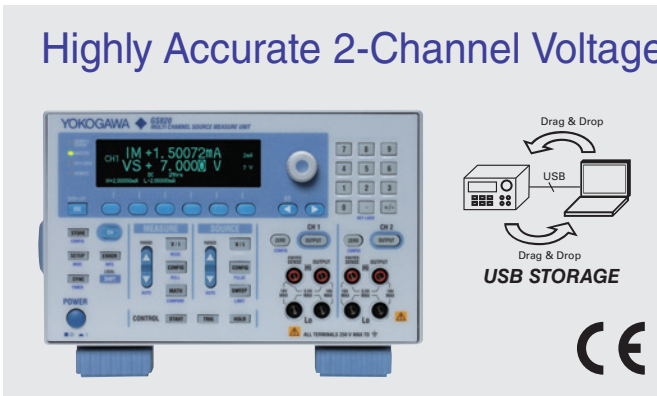

Features

The GS820 is a highly accurate and highly functional 2-channel programmable DC voltage/current source that incorporates voltage/current generation and measurement functions.

- Isolated 2-channel source and measurement function
- Basic accuracy : $\pm 0.02\%$ (DC voltage source)
- 1 pA resolution at extremely small current range 200 nA
- Generate arbitrary waveforms consisting of up to 100,000 points at 100- μ s intervals
- Channel expansion through master-slave synchronization link
- Fast test speeds
- 16-bit digital I/O (model 765602/765612)

Source and Measurement Range

Four-quadrant operation consisting of source operation (current source) and sink operation (current sink) is available. The output and measurement resolutions are 5.5 digits. Two models are available for your application.

18 V range model (765601/02)

Voltage ranges: 200 mV/2 V/7 V/18 V

Maximum output:

- ± 3.2 A (at an output voltage of ± 7 V or less)
- ± 1.2 A (at an output voltage of ± 18 V or less)

Current ranges: 200 nA/2 μ A/20 μ A/200 μ A/
2 mA/20 mA/200 mA/1 A/3 A

Maximum output: ± 18 V (at an output current of ± 1.2 A or less)
 ± 7 V (at an output current of ± 3.2 A or less)

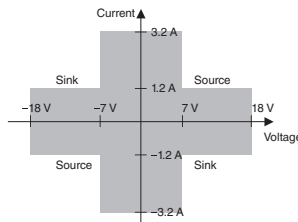

50 V range model (765611/12)

Voltage ranges: 200 mV/2 V/20 V/50 V

Maximum output:

- ± 1.2 A (at an output voltage of ± 20 V or less)
- ± 0.6 A (at an output voltage of ± 50 V or less)

Current ranges: 200 nA/2 μ A/20 μ A/200 μ A/2 mA/
20 mA/200 mA/0.5 A/1 A

Maximum output: ± 50 V (at an output current of ± 0.6 A or less)
 ± 20 V (at an output current of ± 1.2 A or less)

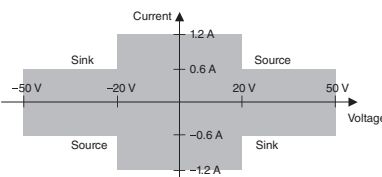

Functions

Source and Measurement Functions

- Voltage source and current measurement (VS&IM)
- Current source and voltage measurement (IS&VM)
- Voltage source (VS)
- Current source (IS)
- Voltmeter (VM)
- Ammeter (IM)
- Resistance meter (IS&VM)

Source

- Function: Voltage or current
- Mode: DC or pulse (pulse width: 50 μ s to 3,600 s)
- Sweep mode: Linear, logarithmic or program (up to 100,000 steps)
- Trigger source: External or internal timers 1 and 2 (period: 100 μ s to 3,600 s)
- Sweep start source: External or internal timers 1 and 2 (period: 100 μ s to 3,600 s)
- Source delay: 15 μ s to 3,600 s
- Response characteristics: Normal or stable

Measurement

- Function: Voltage, current, auto, voltmeter mode, ammeter mode or resistance meter mode
- Integration time: 0.001 to 25 PLC (Power Line Cycle)
- Trigger source: External or internal timers 1 and 2 (period: 100 μ s to 3,600 s)
- Measure delay: 0 μ s to 3,600 s
- Measurement data storage: Up to 100,000 data points
- Average: Moving average (average count: 2 to 256)
- Voltage sense: Two-wire system or four-wire system
- Auto zero: Measure the internal zero reference every measurement and correct the measured value

NULL computation: Computes the difference with respect to the current measured value or user-defined value

User-defined computation: Computes user-defined equations in real-time

External I/O and Communication Interface

- BNC I/O
- Digital I/O
- I/O for synchronized Operation

- D-Sub 15-pin (model 765601/11)
- Half-pitch 50-pin (model 765602/12)
- RJ-11 connector 6-pin, BNC connector
- GPIB
- RS232
- USB
- Ethernet
- 100 BASE-TX/10 BASE-T
- Display: 256 x 64 dot VFD
- Dimensions: Approx. 213(W) x 132(H) x 450(D) mm
- Weight: Approx. 8 kg

Model and Suffix code

Model	Suffix Code	Description
765601		GS820 Multi Channel Source Measure Unit 18 V range/2-bit digital I/O model
765602		GS820 Multi Channel Source Measure Unit 18 V range/16-bit digital I/O model
765611		GS820 Multi Channel Source Measure Unit 50 V range/2-bit digital I/O model
765612		GS820 Multi Channel Source Measure Unit 50 V range/16-bit digital I/O model
Power cord	-D	UL/CSA standard, PSE compliant
	-F	VDE standard
	-R	AS standard
	-Q	BS standard
	-H	GB standard
	-N	NBR standard

Source Measure Unit **GS610**

Combines High Accuracy and High Speed in a Single Unit



Functions

■ Function

- Generation
 - Generation function : Voltage or current
 - Generation mode : DC or pulse
 - Sweep mode : Linear, logarithmic or program (up to 65,535 steps)
- Measurement
 - Measurement function : DC voltage, DC current and resistance
 - Measurement data storage : Up to 65,535 data points
 - Average : Block average or moving average (Specified count: 2 to 256)
- Trigger
 - Trigger mode : Internal, external and immediate
- Time setting
 - Pulse width : 100 μ s to 3,600 s, 1 μ s resolution
 - Period time : 1 ms to 3,600 s, 1 μ s resolution (during source and measure operation)
100 μ s to 3,600 s, 1 μ s resolution (during source-only operation)
 - Source delay : 1 μ s to 3,600 s, 1 μ s resolution
 - Measurement delay : 1 μ s to 3,600 s, 1 μ s resolution
 - Integration time : 250 μ s, 1 ms, 4 ms, 16.6 ms/20 ms, 100 ms, 200 ms (auto detect from the power supply frequency when the power is turned ON for 16.6 ms/20 ms)
- Computation function
 - Operators: +[addition], -[subtraction], *[multiplication], /[division] and ^ [exponentiation]
 - Functions: ABS(), EXP(), LN(), LOG(), SQRT(), SIN(), COS(), TAN(), ASIN(), ACOS(), ATAN(), SINH(), COSH(), TANH(), RAND()

■ External Input/Output

- Synchronization signal input/output (TRIG, SWEEP, CTRL IN and OUT) (BNC)
- External input/output (D-Sub 15-pin)
- GP-IB interface
- RS-232 interface
- USB interface
- Ethernet interface (option) 100BASE-TX/10BASE-T

■ Internal memory

- ROM : 4 MB Area for storing setup and output pattern files
- RAM : 4 MB Area for storing the measured results (cleared when the power is turned OFF)

■ Display

: 256 \times 64 dot vacuum fluorescent display

■ External dimensions

: Approx. 213 (W) \times 132 (H) \times 400 (D) mm (excluding protrusions)

■ Weight

: Approx. 7 kg

Model and Suffix code

Model	Suffix Codes	Description
765501		GS610 Source Measure Unit
Power cord	-D	UL/CSA standard
	-F	VDE standard
	-R	AS standard
	-Q	BS standard
	-H	GB standard
Option	/C10	Ethernet interface

Features

The GS610 is a highly accurate and highly functional programmable voltage/current source that incorporates voltage/current generation and measurement functions. The maximum output voltage and current are 110 V and 3.2 A, respectively. Evaluation of over a wide range of basic electrical characteristics is possible, because the GS610 can operate as a current source or a current sink.

- Source and sink operation up to 110 V/3.2 A (four-quadrant operation)
- Basic accuracy: $\pm 0.02\%$ *1
- Sweep output at up to 100 μ s intervals
- Comes with abundant sweep patterns (linear, logarithmic, and arbitrary)
- Stores up to 65,535 points of source measure data in the internal memory
- Easy file operation with the USB storage function
- Remote control and FTP using Web server function (Optional)

*1: DC voltage generation

Voltage/Current Generation and Measurement Range

Four-dimensional operation with source operation (current source) and sink operation (current sink) is possible at up to 110 V, 3.2 A, and 60 W. The output and measurement resolutions are 5.5 digits.

Voltage generation/measurement range: 200 mV to 110 V

Current generation/measurement range: 20 μ A to 3.2 A

Maximum output current:

- ± 3.2 A (at an output voltage of ± 12 V or less)
- ± 2 A (at an output voltage of ± 30 V or less)
- ± 1 A (at an output voltage of ± 60 V or less)
- ± 0.5 A (at an output voltage of ± 110 V or less)

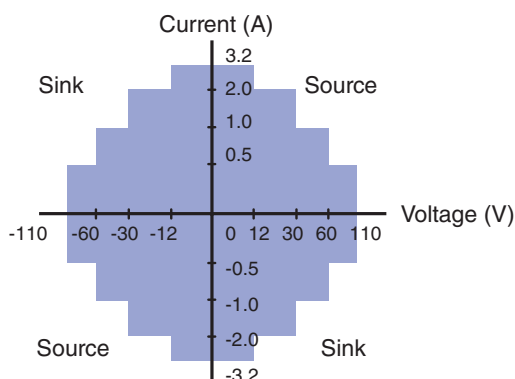

GS Series Accessory Software 765670 Curve Tracer Software for the GS Series

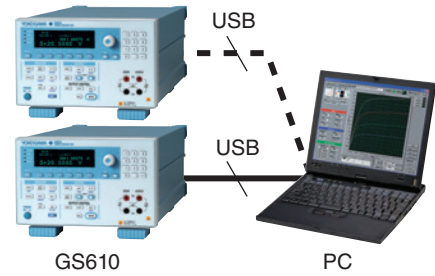
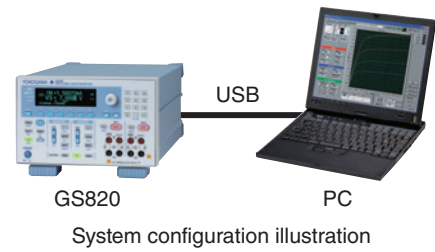
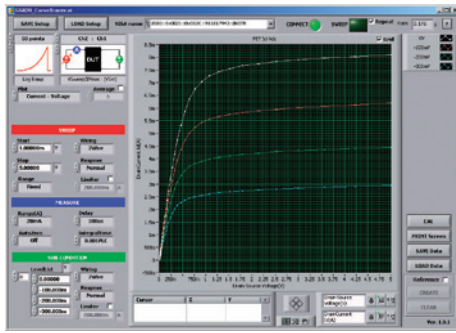

Product Overview

This product is a high-speed, high-accuracy real-time I-V curve tracer that consists of the GS series Source Measure Unit and the 765670 Curve Tracer Software. It is particularly well-suited to DC parametric tests of minute signals.

Features

- **Simple system configuration, easy connection, compact and light**
This system is configured by connecting the GS series Source Measure Unit to a PC that contains the 765670 Curve Tracer Software via USB. You can perform high speed, high-accuracy curve tracing despite its compact size, light weight, and simple system configuration.
- **Real-time, High-Speed Drawing**
The GS series is high-speed communication and sweep features allow high-speed graph update rate up to 25 pages/s(GS820). You can use the real-time curve tracer with comfort.

■ **Field of Applications**

- Discrete semiconductors such as transistors and diodes
- Analog ICs such as voltage regulators and op- amps
- MOS logic and other digital ICs
- LEDs and other optical devices
- Solar battery cells

Drawing Speed (times/s; reference values)

Plot Points	Model Number	
	GS610	GS820
20	20	25
50	10	16
100	5	11
200	3	6

Measurement conditions: Using Core2Duo CPU, 1.5 GHz, USB 2.0, and LabVIEW
Measurement integration time: 0.001 PLC for GS820 / 250 μs for GS610

Specifications

- **Graph drawing:**
Voltage vs. current, voltage vs. voltage, gain vs. voltage, voltage vs. timestamp, current vs. voltage, current vs. current, gain vs. current, current vs. timestamp
Sweep axis: Voltage source or current source
Measurement axis: Voltage measurement or current measurement
Parameter: Voltage source or current source
Sweep shape: Ramp (linear or log), triangle (linear or log), rectangle
Sweep points: 5, 10, 20, 50, 100, 200, 1000
Scaling: Auto scale or fixed scale
Averaging count: 2 to 100
- **Analysis feature:**
Cursor, zoom & scroll, reference curve designation
- **File operations:**
CSV data storage and loading, graphic image storage, panel image storage, setup storage and recall

Examples of Measurements of Characteristics

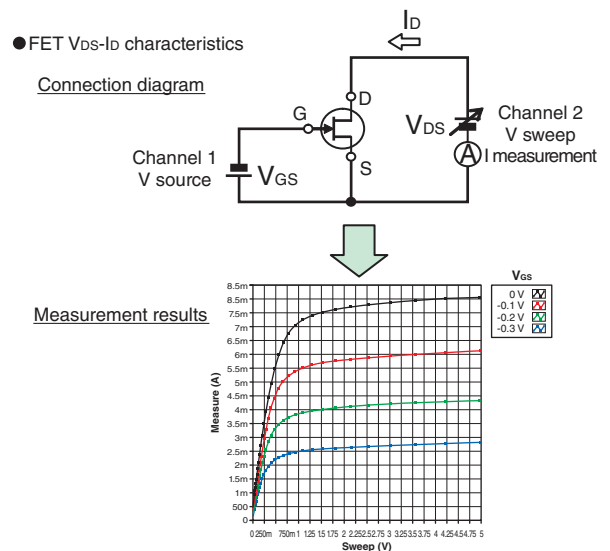

Generators, Sources, Manometers etc.

AC Power Calibrator LS3300

AC Power Calibrator for Highly Accurate, Stable, and Wide Range Output

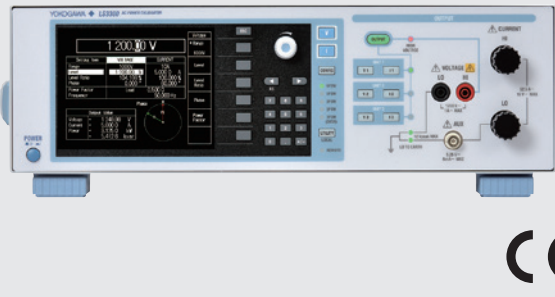

Features

The LS3300 is a single-phase AC power calibrator that can generate highly accurate, stable, and wide range output current and voltage. A single LS3300 unit supports 1P2W, and multiple LS3300 units support 1P3W, 3P3W and 3P4W. It can support AC voltage/current, active/reactive power, power factor and phase angle. It can calibrate Power meter of 0.15% class, Clamp-on power meter, AC clamp-on tester and Power monitor.

- High accuracy (At 1 year) AC voltage: ± 350 ppm ($\pm 0.035\%$)
AC current: ± 450 ppm ($\pm 0.045\%$)
AC power : ± 450 ppm ($\pm 0.045\%$)
- High stability AC voltage, current: ± 50 ppm/h ($\pm 0.005\%/h$)
AC power: ± 100 ppm/h ($\pm 0.01\%/h$)
 $\pm 0.03^\circ$ at 50/60 Hz
- Phase accuracy
- Wide generation range AC voltage: 10 mV to 1250 V
AC current: 0.3 mA to 62.5 A
- Large current output up to 180 A
- The calibration by AUX output

The power meter calibration software supports the automated calibration for the WT series power meters (Free of charge). It is possible to shorten the calibration time.

* For details, please refer to the power meter calibration software on page 48.

Main specification

AC Voltage

Range	Output Range*	Resolution
1 V	0 to 1.25000 V	10 μ V
10 V	0 to 12.5000 V	100 μ V
30 V	0 to 37.5000 V	100 μ V
100 V	0 to 125.000 V	1 mV
300 V	0 to 375.000 V	1 mV
1000 V	0 to 1250.00 V	10 mV

AC Current

Range	Output Range*	Resolution
30 mA	0 to 37.5000 mA	0.1 μ A
100 mA	0 to 125.000 mA	1 μ A
1 A	0 to 1.25000 A	10 μ A
10 A	0 to 12.5000 A	100 μ A
50 A	0 to 62.500 A	1 mA

AUX

Range	Output Range*	Resolution
500 mV	0 to 625.00 mV	10 μ V
5 V	0 to 6.2500 V	100 μ V

*: The output level can be set up to 120% of the range.
For outputs exceeding 120%, the ratio must be set to 100% or higher.

Main specification

Item		Specifications
Voltage	Range	1 V, 10 V, 30 V, 100 V, 300 V, 1000 V
	Level	0 to 120% (of range)
	Level Ratio	0 to 120% (of setting)
	Phase Angle	-180° to $+359.999^\circ$
Current	Range	30 mA, 100 mA, 1 A, 10 A, 50 A, 100 A, 150 A, AUX Output 500 mV, 5 V
	Level	0 to 120% (of range)
	Level Ratio	0 to 120% (of setting)
	Phase Angle	-180° to $+359.999$
Power Factor		LEAD/LAG -1 to 0 to $+1$
Frequency		40 Hz to 1.2 kHz
Wiring	kind of wiring	1P2W, 1P2W (Hi Current), 1P3W, 3P3W, 3P3W (3V3A), 3P4W
	Oscillator	INternal: 40 Hz to 1.2 kHz EXternal: Input from the external oscillator (I/Q) LINE: 50/60 Hz
Sweep	Time	8 s, 16 s, 32 s, 64 s
	Range	0 to 100%, 0 to 105%, 0 to 110%, 0 to 120%
AUX	V/A Conversion Ratio	0.0001 mV/A to 99999.9999 mV/A
Ground/Ungrounded		Voltage and current (including AUX) can be switched separately.
Distortion Rate	Voltage output	0.07% or smaller
	Current output	0.18% or smaller
	AUX output	0.10% or smaller
Response Time		Approx. 2 sec, at 0 \rightarrow 100% of the setting

Output terminal	Type
Voltage	Plug-in terminal (Safety terminal)
Current	Binding post

General Specifications

Item	Specifications
Computer Interface	USB / GPIB / Ethernet
Warm-up time	Approx. 30 minutes
Operating environment	Temperature: 5°C to 40°C
	Humidity: 20% RH to 80% RH
Storage environment	Temperature: -15°C to 60°C
	Humidity: 20% RH to 80% RH
Rated supply voltage	100 VAC to 120 VAC, 200 VAC to 240 VAC
Rated supply frequency	50 Hz/60 Hz
Permitted power supply frequency range	48 Hz to 63 Hz
Maximum power consumption	Approx. 200 VA
External dimensions	426 (W) \times 132 (H) \times 450 (D) mm
Weight	Approx. 20 kg

Model and Suffix code

Model	Suffix code	Description
LS3300		AC Power Calibrator
Power cord	-D	UL/CSA standard, PSE compliant
	-F	VDE standard
	-R	AS standard
	-Q	BS standard
	-H	GB standard
	-N	NBR standard

Precision DC Calibrator 2560A

High-voltage and High-current Output and Intuitive Operation



Bulletin: 2560A-01EN

Features

The 2560A can accurately and stably generate DC voltage of up to 1224 V and DC current of up to 36.72 A. In addition to voltage and current meters, the 2560A can calibrate thermometers and temperature controllers that use thermocouples and RTDs.

- Wide output range DC voltage : ± 1224 V
DC current : -12.24 A to $+36.72$ A
- High accuracy DC voltage : ± 50 ppm (0.005%)
DC current : ± 70 ppm (0.007%)
- High stability DC voltage : ± 10 ppm (0.001%/h)
DC current : ± 20 ppm (0.002%/h)
- High resolution : 5.5 digits, $\pm 120,000$ count display
6.5 digits, $\pm 1,200,000$ count display
- Intuitive operability with dials for each digit
- Sweep, output division, deviation, scale setting
- Ten types of thermocouples, and RTD Pt100
- User-defined temperature calibration, three RJC modes

The power meter calibration software supports the automated calibration for the WT series power meters (Free of charge). It is possible to shorten the calibration time.

* For details, please refer to the power meter calibration software on page 48.

Main Specifications

Voltage and current generating parts

Range	Output range	Resolution
100 mV	± 122.400 mV	1 μ V
1 V	± 12.2400 V	10 μ V
10 V	± 1.22400 V	100 μ V
100 V	± 122.400 V	1 mV
1000 V	± 12.2400 V	10 mV
100 μ A	± 122.400 μ A	1 nA
1 mA	± 12.2400 mA	10 nA
10 mA	± 1.22400 mA	100 nA
100 mA	± 122.400 mA	1 μ A
1 A	± 12.2400 A	10 μ A
10 A	± 1.22400 A	100 μ A
30 A	0 to $+36.720$ A	1 mA

Range	Accuracy (one year) \pm (ppm of setting + V or A)	Stability (1 h) \pm (ppm of setting + V or A)
100 mV	60 + 4 μ V	20 + 3 μ V
1 V	55 + 15 μ V	5 + 5 μ V
10 V	55 + 150 μ V	5 + 50 μ V
100 V	55 + 15 mV	5 + 500 μ V
1000 V	55 + 15 mV	5 + 5 mV
100 μ A	150 + 20 nA	50 + 5 nA
1 mA	70 + 30 nA	5 + 15 nA
10 mA	70 + 300 nA	5 + 150 nA
100 mA	90 + 3 μ A	10 + 1.5 μ A
1 A	350 + 70 μ A	25 + 2.5 μ A
10 A	380 + 12 mA	50 + 500 μ A
30 A	540 + 1.8 mA	70 + 1.2 mA

Main Specifications

Temperature generation for thermocouples

Setting temperature: Accuracy for one year (\pm °C)

R	S	B	J	T
-50°C: 1.10	-50°C: 1.03	400°C: 1.00	-210°C: 0.25	-250°C: 0.72
0°C: 0.80	0°C: 0.75	600°C: 0.70	-100°C: 0.11	-200°C: 0.29
100°C: 0.55	100°C: 0.56	1000°C: 0.50	0°C: 0.08	-100°C: 0.16
600°C: 0.40	400°C: 0.47	1200°C: 0.44	1200°C: 0.15	100°C: 0.10
1600°C: 0.40	1600°C: 0.44	1820°C: 0.44		400°C: 0.09
1768°C: 0.45	1768°C: 0.51			

E	K	N	C	A
-250°C: 0.50	-250°C: 0.94	-240°C: 1.00	0°C: 0.30	0°C: 0.34
-200°C: 0.20	-200°C: 0.30	-200°C: 0.44	200°C: 0.26	100°C: 0.29
-100°C: 0.10	-100°C: 0.15	-100°C: 0.21	600°C: 0.25	600°C: 0.28
0°C: 0.07	0°C: 0.11	0°C: 0.16	1000°C: 0.30	1600°C: 0.47
1000°C: 0.12	800°C: 0.15	800°C: 0.15	2000°C: 0.51	2500°C: 0.79
	1300°C: 0.21	1300°C: 0.20	2315°C: 0.70	

Three RJC modes

INT: Uses a temperature measured at the output terminal as a compensation value.

EXT: Uses a temperature detected by a sensor connected to the RJ sensor terminal as a compensation value.

MAN: Uses a value input manually as a compensation value.

Temperature generation for RTDs

Type	Output range	Resolution	Accuracy (one year)
Pt100	-200.0 to 850.0°C	0.1°C	± 0.12 °C

Resistance generation

Range	Output range	Resolution	Accuracy (one year) \pm (ppm of setting + Ω)
400 Ω	1.00 to 400.00 Ω	0.01 Ω	75 + 0.005

Interface

: USB interface (PC connection)

: Ethernet

: GP-IB

Warm-up time

: Approx. 30 min

Operating environment

: Temperature 5 to 40°C

Humidity 20 to 80%RH

(no condensation)

Rated power supply voltage

: 100 to 120 V AC/200 to 240 V AC

Rated power supply frequency

: 50/60 Hz

Max. power consumption

: Approx. 200 W A

Dimensions

: 426 (W) \times 177 (H) \times 400 (D) mm

Weight

: Approx. 13 kg

Model and suffix codes

Model code	Suffix code	Description
2560A		Precision DC Calibrator
	-VA	Version A
	-UC	Deg C
	-UF	Deg C and F
	-D	UL/CSA standard, PSE compliant
	-F	VDE standard
	-R	AS standard
	-Q	BS standard
	-H	GB standard
	-N	NBR standard

Power Meter Calibration Software (Free Software)

Supports The Automated Calibration for The WT Series Power Meters

Software Overview

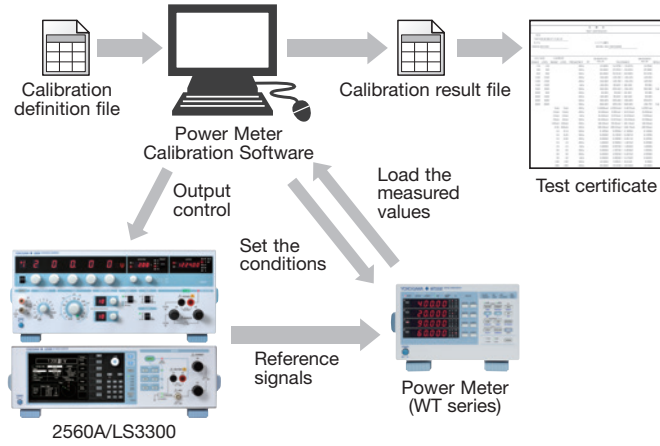

No.	Calibration contents	Generate Measured value	Tolerance	Error rat	Result
1	Voltage 15V Range 15V 60Hz	15.000V	14.970V ~ 15.030V	-26%	
2	Voltage 30V Range 30V 60Hz	30.000V	29.940V ~ 30.060V	-26%	
3	Voltage 60V Range 60V 60Hz	60.000V	59.880V ~ 60.120V	-69%	Warning
4	Voltage 150V Range 150V 60Hz	150.00V	149.70V ~ 150.30V	-30%	
5	Voltage 150V Range 150V 60Hz	150.00V	149.70V ~ 150.30V	-33%	
6	Voltage 150V Range 150V 60Hz	150.00V	149.70V ~ 150.30V	-30%	
7	Voltage 300V Range 300V 60Hz	300.00V	299.40V ~ 300.60V	-26%	
8	Voltage 600V Range 60V 60Hz	60.00V	59.34V ~ 60.66V	-11%	
9	Voltage 600V Range 100V 60Hz	100.00V	99.30V ~ 100.70V	-7%	
10	Voltage 600V Range 300V 60Hz	300.00V	299.10V ~ 300.90V	-3%	
11	Voltage 600V Range 600V 60Hz	600.00V	598.80V ~ 601.20V	-2%	
12	Current 5mA Range 5mA 60Hz	5.0000mA	4.9990mA ~ 5.0010mA	-0.02%	
13	Current 10mA Range 10mA 60Hz	10.000mA	9.9900mA ~ 10.0100mA	-0.10%	
14	Current 20mA Range 20mA 60Hz	20.000mA	19.9800mA ~ 20.0200mA	-0.10%	

Wizard function

For calibration patterns and instrument connection methods, operation instructions and wiring diagrams are shown on the screen.

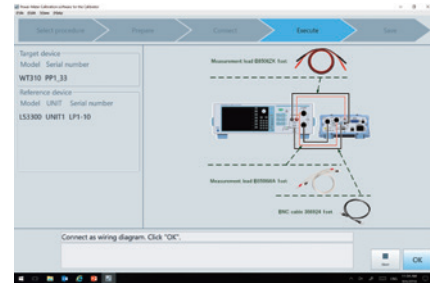

Automatically calibrates a power meter (WT series) using YOKOGAWA's AC Power Calibrator LS3300 or Precision DC Calibrator 2560A!!

Shortening of calibration time

Example: Calibrating WT310E AC 52 points
 Manual calibration: Approx. 20 min
 -> Calibration software : Approx. 2 min 40 sec

Comparison of calibration time	
Manual calibration	approx. 20 min
Calibration software	approx. 2 min 40 sec
	Reduced to 1/8

Features

- Pass/fail judgment of a calibration value "Pass (Blank), Warning, Fail"

Generated val	Measured value	Tolerance	Error ratio	Result
15.000V	14.992V	14.970V ~ 15.030V	-26%	
30.000V	29.984V	29.940V ~ 30.060V	-26%	
60.000V	59.917V	59.880V ~ 60.120V	-69%	Warning
150.00V	149.91V	149.70V ~ 150.30V	-30%	
150.00V	149.90V	149.70V ~ 150.30V	-33%	

Calibration definition file

Sample files are provided for each WT series model. Calibration points can be created arbitrarily as a calibration definition file.

Model	Contents	File name
WT210	WT210 EX1 Sample	WT210_EX1_Sample.csv
WT210	WT210 EX2 Sample	WT210_EX2_Sample.csv
WT210	WT210 Sample	WT210_Sample.csv
WT310E	WT310E AC DCVA Sample	WT310E_AC_DCVA_Sample.csv
WT310E	WT310E AC Sample	WT310E_AC_Sample.csv
WT310E	WT310E Sample	WT310E_Sample.csv
WT310	WT310 AC EX1 Sample	WT310_AC_EX1_Sample.csv
WT310	WT310 AC EX2 Sample	WT310_AC_EX2_Sample.csv
WT310	WT310 AC Sample	WT310_AC_Sample.csv
WT310	WT310 EX1 Sample	WT310_EX1_Sample.csv
WT310	WT310 EX2 Sample	WT310_EX2_Sample.csv
WT310	WT310 Sample	WT310_Sample.csv

Function to calibrate desired points

You can also choose certain desired points from among the created calibration points.

Specifications

- Calibration Target Instruments
WT300E, WT300, WT200, WT100series
- Calibratable point
Output range of LS3300 (AC) and 2560A (DC)
- Supported communication interface
USB, GP-IB, ETHRNET, RS-232

Instrument configuration

Up to 3 units of LS3300, up to 2 units of 2560A can be connected as reference calibrators. Power meter wiring systems are available from single-phase two-wire to three-phase four-wire.

Calibration Function		LS3300	2560A	
AC	Voltage	●	N/A	
	Current	60 A	●	
		120 A	● 2 units	
		180 A	● 3 units	
	Power	1P2W	● 60 A	N/A
			● 120 A 2 units	
		● 180 A 3 units		
1P3W		● 2 units	N/A	
	3P3W	● 2 units	N/A	
	3P4W	● 3 units	N/A	
DC	Voltage	N/A	●	
	Current	N/A	●	
	Power	N/A	● 2 units	

How to download (free of charge)

Registered users can download the software free of charge from our HP.

<https://tmi.yokogawa.com/library/documents-downloads/software/power-meter-calibration-software/>

Precision DC Calibrator 2553A

DC Calibrator for Temperature, Voltage, and Current



Features

The 2553A outputs DC voltage in the range of ± 32 V and DC current in the range of ± 120 mA. In addition to being able to calibrate analog meters, the 2553A can calibrate thermometers and temperature controllers that utilize a thermocouple or RTD.

- High accuracy DC voltage : ± 75 ppm (0.0075%)
- High accuracy DC current : ± 120 ppm (0.012%)
- High stability : ± 15 ppm (0.0015%) / h
- Low noise : $2 \mu\text{Vrms}$
- High resolution : 5.5 digits
- Intuitive operation by dials
- 10 types of thermocouple and RTD Pt100
- User defined temperature calibration
- 3 RJC modes
- Calibration by temperature value

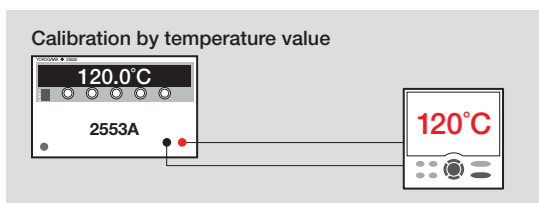

Main specification

Voltage, current generation

Range	Source range	Resolution
10 mV	± 12.0000 mV	100 nV
100 mV	± 120.000 mV	1 μV
1 V	± 120000 V	10 μV
10 V	± 12.0000 V	100 μV
30 V	± 32.000 V	1 mV
1 mA	± 120000 mA	10 nA
10 mA	± 12.0000 mA	100 nA
30 mA	± 32.000 mA	1 μA
100 mA	± 120.000 mA	1 μA

Range	Accuracy (1 year) \pm (ppm of setting + μV or μA)	Stability (1 hour) \pm (ppm of setting + μV or μA)
10 mV	60 + 4	20 + 3
100 mV	60 + 4	20 + 3
1 V	60 + 15	5 + 10
10 V	60 + 150	5 + 100
30 V	60 + 450	5 + 300
1 mA	80 + 0.04	5 + 0.015
10 mA	100 + 0.5	5 + 0.15
30 mA	100 + 1.5	10 + 0.9
100 mA	100 + 5	10 + 3

Main specification

Temperature generation for Thermocouple

Setting temperature : Accuracy for 1 year ($\pm^\circ\text{C}$)

R	S	B	J	T
-50°C: 1.10	-50°C: 1.03	400°C: 1.00	-210°C: 0.25	-250°C: 0.72
0°C: 0.80	0°C: 0.75	600°C: 0.70	-100°C: 0.11	-200°C: 0.29
100°C: 0.55	100°C: 0.56	1000°C: 0.50	0°C: 0.08	-100°C: 0.16
600°C: 0.40	400°C: 0.47	1200°C: 0.44	1200°C: 0.15	100°C: 0.10
1600°C: 0.40	1600°C: 0.44	1820°C: 0.44		400°C: 0.09
1768°C: 0.45	1768°C: 0.51			

E	K	N	C	A
-250°C: 0.50	-250°C: 0.94	-240°C: 1.00	0°C: 0.30	0°C: 0.34
-200°C: 0.20	-200°C: 0.30	-200°C: 0.44	200°C: 0.26	100°C: 0.29
-100°C: 0.10	-100°C: 0.15	-100°C: 0.21	600°C: 0.25	600°C: 0.28
0°C: 0.07	0°C: 0.11	0°C: 0.16	1000°C: 0.30	1600°C: 0.47
1000°C: 0.12	800°C: 0.15	800°C: 0.15	2000°C: 0.51	2500°C: 0.79
	1300°C: 0.21	1300°C: 0.20	2315°C: 0.70	

3 RJC modes

INT: Detect temperature of output terminal as compensation value

EXT: Detect compensation value by sensor connected to RJC terminal

MAN: Input compensation value

Temperature generation for RTD

Type	Source range	Resolution	Accuracy (1 year)
Pt100	-200.0 to 850.0°C	0.1°C	$\pm 0.15^\circ\text{C}$

Resistance generation

Range	Source range	Resolution	Accuracy (1 year) \pm (ppm of setting + Ω)
400 Ω	18.00 to 400.00 Ω	0.01 Ω	75 + 0.015

Interface	: USB
	: Ethernet
	: GPIB
Warm-up time	: Approx. 30 minutes
Operating environment	: Temperature 5 to 40°C
	: Humidity 20 to 80% RH
Storage environment	: Temperature -15 to 60°C
	: Humidity 20 to 80% RH
Operating Height	: 2000 m or less
Operating Attitude	: Horizon
Rated power supply voltage	: 100 to 120 VAC/200 to 240 VAC
Allowable power supply voltage fluctuation range	: 90 to 132 VAC/180 to 264 VAC
Rated power supply frequency	: 50/60 Hz
Allowable power supply frequency fluctuation range	: 48 to 63 Hz
Max. power consumption	: 30 VA
Withstand voltage	: Between power and case 1500 VAC 1 min.
Dimensions	: 213 (W) \times 132 (H) \times 300 (D) mm
Weight	: Approx. 3 kg

Model and Suffix code

Model	Suffix code	Description
2553A		Precision DC Calibrator
	-VA	Version A
	-UC	Deg C
	-UF	Deg C and F
	-D	UL/CSA standard, PSE
	-F	VDE standard
	-R	AS standard
	-Q	BS standard
	-H	GB standard
	-N	NBR standard

AC Voltage Current Standard 2558A

AC Standard Source with Improved Performance and Usability



2558A



Functions and Specifications

Stability	: $\pm(20 \text{ ppm of setting} + 30 \text{ ppm of range})/\text{h}$
Distortion factor	Voltage : 0.07% or less
	Current : 0.18% or less
Frequency range	Internal : 50 / 60 / 400 Hz / VAR VAR: 40 to 1000 Hz (0.001 Hz resolution)
	External : EXT1/EXT2 (Use the terminals for synchronized operations)
FREQUENCY METER	: MIN/MAX 20 to 1000 Hz (0.001 Hz resolution)
	Sweep, output divider and deviation functions are used for the frequency.
Sweep	Target : Voltage / Current / Frequency Speed : Approx. 8/16/32/64 sec. selectable
	Output divider
Deviation	
	Output terminal Type
Interface	
	Warm-up time
Operating environment	Temperature : 5 to 40°C Humidity: 20 to 80%RH (no condensation)
	Rated power supply voltage
Rated power supply frequency	: 50/60 Hz
Max. power consumption	: 200 VA
Weight	: Approx. 20 kg
Dimensions	: 426(W) \times 132(H) \times 400(D) mm

Features

The wide output ranges of 1.00 mV to 1200.0 V AC and 1.00 mA to 60.00 A AC mean that the 2558A is the instrument of choice for the cost effective calibration of AC analog meters.

- Wide output range AC voltage : 1.00 mV to 1200.0 V
AC current : 1.00 mA to 60.00 A
- High accuracy AC voltage : 0.04%
AC current : 0.05%
- High output stability : ± 50 ppm/h
- Wide frequency range : 40 to 1000 Hz
Accuracy : ± 50 ppm
- Intuitive operation with dials for setting each digit
- Sweep function : 8/16/32/64 sec. (selectable)
- Output divider function (Divided output of the main setting)
- Direct readout of the deviation (Displays the deviation from the main setting)

Functions and Specification

Output

Range	Output Range	Guaranteed Accuracy Range
100 mV	0 to 144.00 mV	1 to 120.00 mV
1 V	0 to 144.00 V	0.01 to 120.00 V
10 V	0 to 14.400 V	0.1 to 12.000 V
100 V	0 to 144.00 V	1 to 120.00 V
300 V	0 to 432.0 V	3 to 360.0 V
1000 V	0 to 1440.0 V	10 to 1200.0 V
100 mA	0 to 144.00 mA	1 to 120.00 mA
1 A	0 to 144.00 A	0.01 to 120.00 A
10 A	0 to 14.400 A	0.1 to 12.000 A
50 A	0 to 72.00 A	0.5 to 60.00 A

Accuracy (180 days)

1 to 10% output of range $\pm(\%$ of range)

Voltage	50/60 Hz	: 0.013
	40 to 400 Hz	: 0.015
	400 to 1000 Hz	: 0.030

Current	50/60 Hz	: 0.014
	40 to 400 Hz	: 0.016
	400 to 1000 Hz	: 0.032

10 to 120% output of range $\pm(\%$ of setting + % of range)

Voltage	50/60 Hz	: 0.03 + 0.01
	40 to 400 Hz	: 0.05 + 0.01
	400 to 1000 Hz	: 0.10 + 0.02

Current	50/60 Hz	: 0.04 + 0.01
	40 to 400 Hz	: 0.06 + 0.01
	400 to 1000 Hz	: 0.12 + 0.02

Model and Suffix Codes

Model	Suffix Code	Description
2558A		AC Voltage Current Standard
Power cord	-D	UL/CSA standard, PSE
	-F	VDE standard
	-R	AS standard
	-Q	BS standard
	-H	GB standard
	-N	NBR standard
Option	/C1	GP-IB interface

Digital Multimeter **DM7560**

Bring new value by the multiple display formats and high sampling speed



Features

The DM7560 provides high sampling rates of up to 30 kS/s with high accuracy and provides all the basic functions of a Digital Multimeter. With its capability to monitor transitional voltage variations, it can be applied to a wide range of applications.

- Multiple display formats
- High speed data logging (Maximum 30 kS/s)
- High capacity internal memory up to 100 k points
- Offline browsing to provide trend and histogram analysis
- Productivity improvement by varied interfaces

Functions and Specifications

DC voltage (DCV)	Range: 100 mV to 1000 V Accuracy: $\pm(0.0035\%$ of reading + 0.0005% of range) at the 10 V range
DC current (DCI)	Range: 1 mA to 3 A Accuracy: $\pm(0.050\%$ of reading + 0.005% of range) at the 100 mA range
AC voltage (ACV)	Range: 100 mV to 750 V (Frequency: 20 Hz to 300 kHz, up to 100 kHz at the 750 V range) Accuracy: $\pm(0.06\%$ of reading + 0.03% of range) at the 1 to 750 V range and 100 Hz to 20 kHz
AC current (ACI)	Range: 1 to 3 A (Frequency: 20 Hz to 5 kHz) Accuracy: $\pm(0.10\%$ of reading + 0.04% of range) at the 1 A range and 100 Hz to 5 kHz
Resistance measurement (2 W Ω /4 W Ω)	Range: 100 Ω to 100 M Ω Accuracy: $\pm(0.010\%$ of reading + 0.001% of range) at the 1 M Ω range
Continuity test (CONT)	Resistance range: 1 k Ω
Diode test	Measuring current: Approx. 1 mA
Temperature measurement (TEMP, TC)	Thermocouple type: R/K/T/J/E (Internal RJC is not supported)
Temperature measurement (TEMP, RTD)	Resistance temperature detector: Pt100, JPt100
Frequency measurement (FREQ)	Range: 3 Hz to 300 kHz Accuracy: $\pm 0.01\%$ of reading at 40 Hz to 300 kHz

Generators, Sources, Manometers etc.

Model and suffix codes

Model code	Suffix code	Description
DM7560		Digital Multimeter
Supply voltage	-1	100 VAC, 50/60 Hz
	-3	115 VAC, 50/60 Hz
	-6	220 VAC, 50/60 Hz
	-8	240 VAC, 50/60 Hz
Power cord	-D	UL/CSA standard, PSE compliant
	-F	VDE Standard
	-R	AS Standard
	-Q	BS Standard
	-H	GB Standard
	-N	NBR Standard
Options	/C1	GP-IB Interface*
	/C2	LAN & RS-232 Interface*
	/CMP	DIO Interface

* Only one can be selected.

Advantage points

Comprehensive observation by multiple display formats

Annunciator
Indicates the status of the instrument status by icons.

Primary display (examples)

- Trend display (Plots time domain variation)
- Histogram display (Plots distribution)
- Arc scale meter display (Shows values intuitively)

Secondary display (examples)

- Analog meter display
- Statistics display
- LIMIT judgment display

High-speed data logging

The case of 10 ms pulse width, 2 Vpp measurement with DC voltage measuring function.

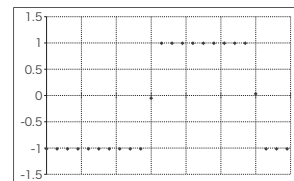

Sample of 1 kS/s

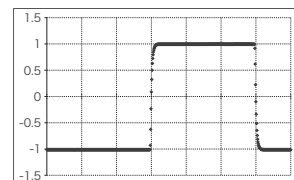

Sample of 30 kS/s

Fast signal change can be measured exactly with high sampling rate.

Arbitrary/Function Generator **FG400 Series**

Easily Generate Basic, Application Specific and Arbitrary Waveform



FG420



Functions and Specifications

- Number of channels FG410: 1-channel model
FG420: 2-channel model
- Output waveforms Sine, square, pulse, ramp, DC, parameter-variable waveform (25 types), noise (Gaussian distribution), arbitrary waveform
- Oscillation modes Continuous, modulation, sweep, burst, sequence
- Frequency Sine 0.01 μ Hz to 30 MHz
Square/pulse 0.01 μ Hz to 15 MHz
Ramp/parameter-variable waveform 0.01 μ Hz to 5 MHz
- Arbitrary waveform Waveform length 4 K to 512 K words or 2 to 10,000 control points
- Modulation type FM, FSK, PM, PSK, AM, DC offset, PWM
- Sweep type Frequency, phase, amplitude, DC offset, duty
- Synchronization Sync operation is possible. Up to 6 units can be connected with BNC cables in the form of master/slave connections, using the frequency reference output and external 10 MHz frequency reference input
- Power supply AC 100 V to 230 V \pm 10% (250 V max.)
50 Hz/60 Hz \pm 2 Hz
- Power consumption FG410 50 VA or less
FG420 75 VA or less
- Weight Approx. 2.1 kg
- Dimensions 216 (W) \times 88 (H) \times 332 (D) mm

Features

The FG400 Arbitrary/Function Generator provides a wide variety of waveforms as standard and generates signals simply and easily. There are one channel (FG410) and two channel (FG420) models. As the output channels are isolated, an FG400 can also be used in the development of floating circuits. (up to 42 V)

- 0.01 μ Hz to 30 MHz output (sine wave)
- 20 Vp-p output/open, 10 Vp-p output/50 Ω
- Arbitrary waveform generation function
- 3.5-inch color display
- Up to 6 units (12 channels) can be synchronized
- A variety of sweeps, modulations and functions
- Parameter-variable waveforms

Models and Suffix Codes

Model	Suffix code	Description
FG410		Arbitrary /Function Generator, 1-Channel Model
FG420		Arbitrary /Function Generator, 2-Channel Model
Power cord	-D	UL/CSA standard, PSE
	-F	VDE standard
	-R	AS standard
	-Q	BS standard
	-H	GB standard
	-N	NBR standard

Related Software

XviewerLITE

This software allows you to display the waveforms and measurement results on a PC for the data measured with Yokogawa's DLM/DL/SL series. It allows you to clip part of a waveform and generate an arbitrary waveform with the FG400.

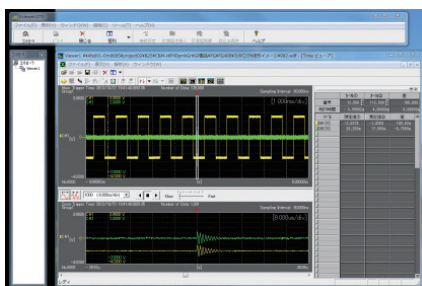

Arbitrary Waveform Editor

This software supports the arbitrary waveform function of the FG400. It allows you to edit waveforms and transfer data to the FG400. It also makes it easy to work on a pre-installed waveform to generate an arbitrary waveform.

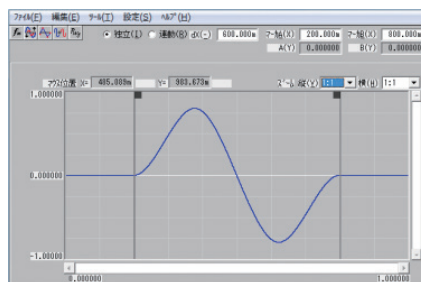

Sequence Editor

This software supports the sequence function of the FG400 that outputs different waveforms sequentially. It controls the edit, transfer, and execution of sequence data. Complex programs can also be created easily.

ステップ	波形	ARB	周波数設定	振幅	位相	パルス幅	Duty Enable
0	Sine	----	1000	Norm	+FS	0	----
1	Sine	----	1000	Norm	+FS	0	----
2	Sine	----	1000	Norm	+FS	0	----
3	Sine	----	1000	Norm	+FS	0	----
4	Sine	----	1000	Norm	+FS	0	----
5	Sine	----	1000	Norm	+FS	0	----
6	Sine	----	1000	Norm	+FS	0	----
7	Sine	----	1000	Norm	+FS	0	----
8	Sine	----	1000	Norm	+FS	0	----
9	Sine	----	1000	Norm	+FS	0	----
10	Sine	----	1000	Norm	+FS	0	----

Generators, Sources, Manometers etc.

Pneumatic Pressure Standard **MC100****High Accuracy and Long Term Stability****Features**

- High accuracy: $\pm 0.05\%$ of full scale
- Output ranges and resolution:
 - 0 to 25 kPa range model (767401) :
0 to 25 kPa (resolution 0.001 kPa)
 - 0 to 200 kPa range model (767402):
0 to 200 kPa (resolution 0.01 kPa)
- Useful functions for instrument calibration:
Divided output, auto-step output, and sweep output
- Excellent temperature coefficient:
Zero point: $\pm 0.003\%$ of full scale/ $^{\circ}\text{C}$
Span: $\pm 0.002\%$ of full scale/ $^{\circ}\text{C}$

Main Specifications

Supplied input	50 \pm 10 kPa (767401) / 280 \pm 20 kPa (767402)
Max. allowable input	100 kPa gauge (767401) / 500 kPa gauge (767402)
Output noise	$\pm 0.02\%$ of full scale
Influence of positional setup	90° tilt forward or backward: $\pm 0.1\%$ of full scale (767401) / $\pm 0.01\%$ of full scale (767402) 30° tilt right or left : $\pm 2.5\%$ of full scale (767401) / $\pm 0.2\%$ of full scale (767402)
Readout unit (Select from the following when ordered)	kPa only; kPa, kgf/cm ² , mmHg, mmH ₂ O (selectable); kPa, inH ₂ O, inHg, psi (selectable)
Supply pressure source	Dry air only. Temperature must be between 5 $^{\circ}\text{C}$ and 40 $^{\circ}\text{C}$, and the amount of temperature change must be small.
Air consumption rate	Approx. 30 L/min (with supply pressure in specified range)

Basic Specifications

Warm-up time	Approx. 5 min
Operating temperature and humidity	5 $^{\circ}\text{C}$ to 40 $^{\circ}\text{C}$, 20 to 80%RH, no condensation
Maximum operating altitude	2000 m
Storage temperature range	-20 $^{\circ}\text{C}$ to 60 $^{\circ}\text{C}$
AC power ratings	100 to 120 VAC/200 to 240 VAC, at 50/60 Hz
Power consumption	40 VA Max. (100 to 120) / 50 VA Max. (200 to 240 V)
Dimensions	Approx. 213 mm (W) \times 132 mm (H) \times 400 mm (D), excluding protrusions
Weight	Approx. 9.5 kg

Functions

- Divided output function with as many as 20 steps.
Outputs a pressure equal to the specified value x n/m ($n = 0$ to m , $m = 1$ to 20)
- Auto-step output function
Divider output is automatically generated in steps.
Interval time : 10 to 600 seconds in 5-second intervals
Repetitions : One to infinity (stopping partway through is also permitted)
- Sweep output function
The generated pressure is increased or decreased linearly over the interval time from 0% to 100% of the set pressure.

Models & Suffix Codes

Model	Suffix Codes	Description
767401	-	Pneumatic pressure Standard (25 kPa range model)
767402	-	Pneumatic pressure Standard (200 kPa range model)
Pressure unit	-U1	Displayed unit: kPa
	-U2	Displayed unit: kPa, kgf/cm ² , mmH ₂ O, and mmHg
	-U3	Displayed unit: kPa, psi, inH ₂ O, and inHg
Communication function	-C1	GP-IB interface
	-C2	RS-232 interface
I/O connection unit	-P1	Rc 1/4" female-thread
	-P2	1/4" NPT female-thread
Power cord	-B	Indian Standard
	-D	UL/CSA Standard and PSE compliant
	-F	VDE/Korean Standard
	-H	Chinese Standard
	-N	Brazilian Standard
	-Q	BS/Singapore Standard
	-R	Australian Standard
	-T	Taiwanese Standard
-U	IEC Plug Type B	

Digital Manometer **MT300****High Accuracy and Long Term Stability****Main Specifications**

Display resolution	6 digits Max. (7 digits Max. when /R1 is selected)
Guaranteed accuracy range	
G01 (10 kPa gauge pressure model)	-10 kPa to 10 kPa
G03 (200 kPa gauge pressure model)	-80 kPa to 200 kPa
G05 (1000 kPa gauge pressure model)	-80 kPa to 1000 kPa
G06 (3500 kPa gauge pressure model)	-80 kPa to 3500 kPa
G07 (16 MPa gauge pressure model)	0 kPa to 16000 kPa
G08 (70 MPa gauge pressure model)	0 kPa to 70000 kPa
A03 (130kPa absolute pressure model)	0 kPa to 130 kPa abs
A05 (700kPa absolute pressure model)	0 kPa to 700 kPa abs
A06 (3500kPa absolute pressure model)	0 kPa to 3500 kPa abs
D00 (1 kPa Differential pressure model)	0 kPa to 1 kPa
D01 (10 kPa Differential pressure model)	0 kPa to 10 kPa
D03 (130 kPa Differential pressure model)	0 kPa to 130 kPa
D05 (700 kPa Differential pressure model)	0 kPa to 700 kPa
Readout unit	Pa, hPa, kPa, MPa, mbar, bar, atm only, or add mmHg, inHg, gf/cm ² , kgf/cm ² , Torr, psi, mmH ₂ O@4°C, mmH ₂ O@20°C, ftH ₂ O@4°C, ftH ₂ O@20°C, inH ₂ O@4°C, inH ₂ O@20°C
Applicable fluids	Gases and liquid (non-flammable, non-explosive, non-toxic and non-corrosive fluids)

Basic Specifications

Display device	4.3-inch TFT color LCD
Warm-up time	Approx. 5 min
Operating temperature and humidity	5°C to 40°C, 20 to 80%RH, no condensation 10°C to 35°C, 20 to 80%RH, no condensation (when -D00 is selected)
Operating altitude range	2000 m or less
Storage temperature range	-20°C to 60°C RH, no condensation
Power Supply	AC or Li-ion battery (739883) with battery pack cover (269918)
AC power rating	100 to 120 VAC/200 to 240 VAC, at 50/60 Hz
Dimensions	Approx. 213 mm (W) × 132 mm (H) × 350 mm (D), excluding protrusions
Weight	Approx. 6.2 kg (When -G03 selected.)

Features**High accuracy and long term stability**

- Relative accuracy* of pressure measurement: 0.01%
- Accuracy guarantee period: 12 months

*Relative value for the measure toward the working standard of YOKOGAWA.

Rich lineup

- Gauge pressure models: 10 kPa, 200 kPa, 1000 kPa, 3500 kPa, 16 MPa, 70 MPa
- Absolute pressure models: 130 kPa, 700 kPa, 3500 kPa
- Differential pressure models: 1 kPa, 10 kPa, 130 kPa, 700kPa

Functions**For High precision measurements**

- High resolution display (When /R1 is selected.)
- Synchronous measurement
- High speed measurement (When /F1 is selected.)

Support for efficient works

- Leak test
- Scaling
- Statistical processing (Max, Min, Avg and σ)

Support for linkage with external devices

- D/A output (When /DA is selected)
- Comparator output
- GPIB, USB (type-B), and ETHERNET are available as standard features.

Battery operation

- Running time: Approx. 6 hours with all functions turned on
- Charge time: Approx. 6 hours

Model and Suffix code

Model	Suffix code	Descriptions
MT300		Digital Manometer
Pressure type and range	-G01	10 kPa range Gauge pressure model
	-G03	200 kPa range Gauge pressure model
	-G05	1000 kPa range Gauge pressure model
	-G06	3500 kPa range Gauge pressure model
	-G07	16 MPa range Gauge pressure model
	-G08 ^{*1}	70 MPa range Gauge pressure model
	-A03	130 kPa range Absolute pressure model
	-A05	700 kPa range Absolute pressure model
	-A06	3500 kPa range Absolute pressure model
	-D00	1 kPa range Differential pressure model
Pressure unit	-D01	10 kPa range Differential pressure model
	-D03	130 kPa range Differential pressure model
	-D05	700 kPa range Differential pressure model
	-U1	Pa, hPa, kPa, MPa, mbar, bar, atm
	-U2	Pa, hPa, kPa, MPa, mbar, bar, atm, mmHg, inHg, gf/cm ² , kgf/cm ² , Torr, psi, mmH ₂ O@4°C, mmH ₂ O@20°C, ftH ₂ O@4°C, ftH ₂ O@20°C, inH ₂ O@4°C, inH ₂ O@20°C
Input connection	-P1	Rc 1/4" female-thread
	-P2	1/4" NPT female-thread
	-P3	VCO 1/4" male-thread
	-P4 ^{*2}	1/2" NPT female-thread
Power cord	-D	UL/CSA Standard and PSE compliant
	-F	VDE/Korean Standard
	-Q	British Standard
	-R	Australian Standard
	-H	Chinese Standard
	-N	Brazilian Standard
	-T	Taiwanese Standard
	-B	Indian Standard
-U	IEC Plug Type B	
Option	/F1 ^{*3}	Measurement mode switching function (Normal, Medium or High)
	/DM ^{*4}	DCV/DCA measurement, 24 VDC output
	/DA	DA conversion output
	/R1 ^{*5}	One additional display resolution digit
	/EB	Battery pack + battery pack cover

*1: -G08 is shield gauge pressure model.

*2: When -G08 is selected, only -P4 can be selected for -G08.

*3: Not selectable for -G07, -G08, or the differential pressure model.

*4: Selectable on the gauge pressure model and absolute pressure model.

*5: Not selectable for -G08 or -D00.

Optical Spectrum Analyzer **AQ6370 Series**

High Performance Optical Spectrum Analyzers Meeting Measurement Needs in a Broad Range of Applications

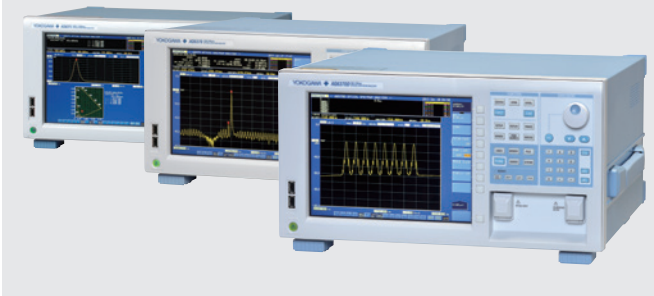

Three Models Covering a Wide Wavelength from 350 nm to 5500 nm

- **AQ6370D (600 to 1700 nm)**
Standard model optimized to the wavelengths often used in telecommunication applications
- **AQ6373B (350 to 1200 nm)**
Model for short-wavelength including visible light (VIS)
- **AQ6374 (350 to 1750 nm)**
Wide range model covering the spectrum from visible to communication wavelengths
- **AQ6375B (1200 to 2400 nm)/AQ6376 (1500 to 3400 nm)/AQ6377 (1900 to 5500 nm) NEW!**
Model for emerging applications in exNIR+MWIR regions

Optical Applications

Today, optical technology is used in a wide variety of applications, which include biomedical application and environmental measurement, as well as information and communication, where demand for broadband connectivity is growing rapidly, driven by the popularity of the Internet, IP telephony, and video streaming. Yokogawa's optical spectrum measurement technology contributes to the development of such optical applications.

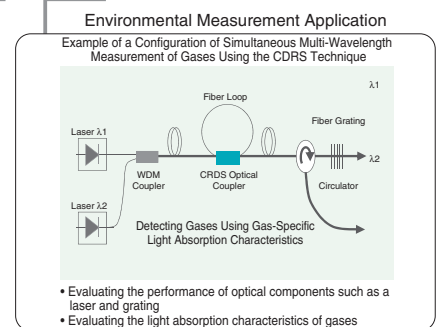
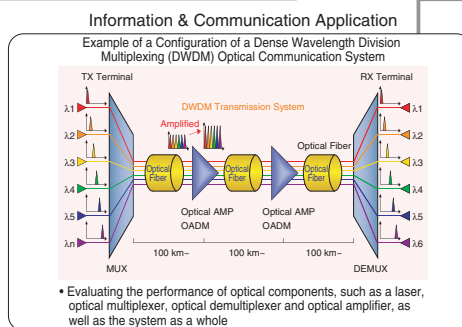
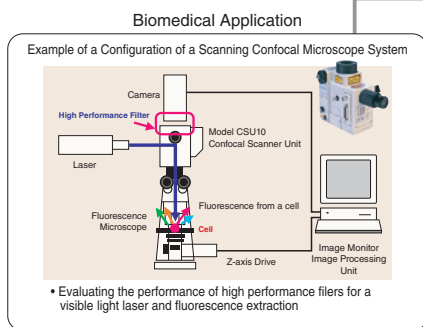
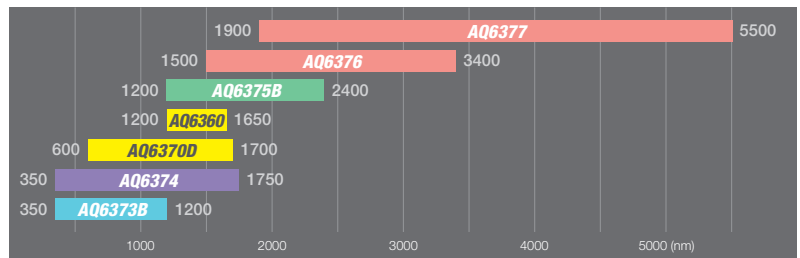

AQ6370 Series of Optical Spectrum Analyzers Common Specifications

Items	Specifications
Electrical interface	GP-IB, RS-232, Ethernet, USB, SVGA output, Analog output port, Trigger input port, Trigger output port
Remote control ¹⁾	GP-IB, RS-232, Ethernet (TCP/IP), AQ6317 series compatible commands (IEEE488.1) and IEEE488.2
Purge gas input/output terminals ²⁾	Outer diameter 1/4 inch, nylon tube
Data storage	Internal storage: 512 MBytes, Internal memory: 64 Traces, 64 programs, 3 template lines, External storage: USB storage (memory/HDD), FAT32 format File types: CSV (text), Binary, BMP, TIFF
Display ²⁾	10.4-inch color LCD (Resolution: 800 × 600)
Dimensions	Approx. 426 (W) × 221 (H) × 459 (D) mm (Excluding protector and handle)
Mass	AQ6370D/AQ6373B/AQ6374: Approx. 19 kg, AQ6375B/AQ6376/AQ6377: Approx. 23 kg
Power requirements	100 to 240 V AC, 50/60 Hz, approx. 100 VA
Environmental conditions	Performance guarantee temperature: +18 to +28°C, Operating temperature: +5 to +35°C, Storage temperature: -10 to +50°C, Humidity: 20 to 80%RH (no condensation)
Safety standards	EN 61010-1
Recommended calibration period	Laser ⁴⁾
	1 year

¹⁾ Some AQ6317 series commands may not be compatible due to changes in specifications or functions. ²⁾ Liquid crystal display may include a few defective pixels (within 0.002% with respect to the total number of pixels including RGB). There may be a few pixels on the liquid crystal display that do not emit all the time or remains ON all the time. These are not malfunctions. ³⁾ AQ6374, AQ6375B, AQ6376, and AQ6377 ⁴⁾ With built-in calibration light source

Optical communication model **AQ6370D**

Redefining Optical Spectrum Measurement Excellence



Features

- **World Class Optical Performance & Flexibility**
 High wavelength accuracy: ± 0.01 nm
 High close-in dynamic range: 78 dB typ.
 Single and multimode fiber test capability (up to GI 62.5/125 μ m)
- **Improved Measurement Throughput**
 Double-speed mode
 Fast measurement and fast data transfer
- **Enhanced User Friendliness**
 USB for Mouse, keyboard, and external storage devices
 Bright 10.4" LCD
 Trace zoom capability
 Various built-in analysis functions
- **Expedites Development of Automated Test Systems**
 Supports GP-IB, RS-232C, and Ethernet interfaces
 Compatible with SCPI and supports AQ6317 series remote commands
 Built-in simple macro programming function
- **Includes Wavelength Calibration Source (Optional)**
- **AQ6370 Viewer: Emulation/Remote control software (Optional)**

Enhanced functions

- **Data logging function**
 The Data Logging function records analysis results such as WDM analysis (OSNR, optical signal/noise ratio), distributed feedback laser diode (DFB-LD) analysis, and multi-peak measurements at up to 10,000 points per channel with time stamps. Recorded data can be displayed in table and graphical forms.
- **Advanced marker function**
 The Advanced Marker function adds markers to obtain the power density and the integrated power of a designated spectrum.
- **Gate sampling function**
 The Gate Sampling function facilitates the recirculating loop testing of optical transmission systems.
- **Resolution calibration function**
 The Resolution Calibration function is used to calibrate the noise equivalent bandwidth with an external light source.

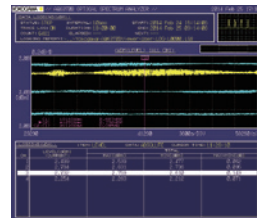

Data Logging display

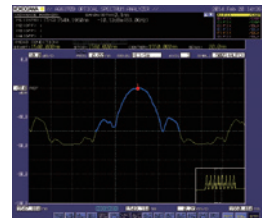

Advanced marker display

World-class optical performance

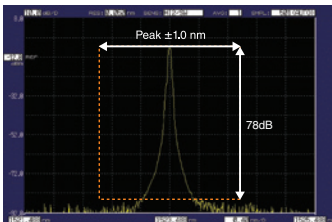

Example of the dynamic range

Peak ± 1.0 nm, Resolution setting 0.05 nm, High dynamic mode: ON, High performance model



DWDM signal measurement

DWDM channels allocated at 50 GHz spacing can be measured and analyzed.

Enhanced User Friendliness

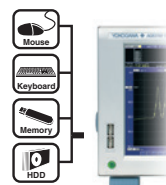

USB interface

Supports mouse, keyboard, and external storage devices.

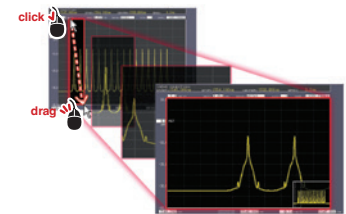

Trace zoom function

Enlarges a designated area

Main Specifications

Items	Specifications	
	Standard (-12)	High performance (-22)
Wavelength range ^{*1}	600 to 1700 nm	
Span ^{*1}	0.1 nm to 1100 nm (Full span), and 0 nm	
Wavelength accuracy ^{*1, *2, *5}	± 0.02 nm (1520 to 1620 nm)	
Wavelength resolution setting ^{*1, *2}	0.02, 0.05, 0.1, 0.2, 0.5, 1 and 2 nm	
Number of sampling	101 to 50001, AUTO	
Level sensitivity setting	NORM_HOLD, NORM_AUTO, NORMAL, MID, HIGH1, HIGH2 and HIGH3	
High dynamic mode	SWITCH (Sensitivity: MID, HIGH1-3)	
Level sensitivity ^{*2, *3, *4, *7}	-90 dBm (1300 to 1620 nm), -85 dBm (1000 to 1300 nm), -60 dBm (600 to 1000 nm) (Sensitivity: HIGH3)	
Maximum input power ^{*2, *3}	+20 dBm (Per channel, full range)	
Level accuracy ^{*2, *3, *4, *6}	± 0.4 dB (1310/1550 nm, Input level: -20 dBm, Sensitivity: MID, HIGH1-3)	
Dynamic range ^{*1, *2, *8}	Resolution: 0.02 nm	55 dB (Peak ± 0.2 nm), 37 dB (Peak ± 0.1 nm)
	Resolution: 0.1 nm	57 dB (Peak ± 0.4 nm), 40 dB (Peak ± 0.2 nm)
Stray-light suppression ratio ^{*2, *10}	73 dB	
Applicable fiber	SM (9.5/125 μ m), GI (50/125 μ m, 62.5/125 μ m)	
Optical connector	Optical input: AQ9447 (□) Connector adapter (option) required. Calibration output: AQ9441 (□) Universal adapter (option) required. (□) Connector type FC or SC	
Built-in calibration light source ^{*11}	Wavelength reference source (For optical alignment and wavelength calibration)	
Sweep time ^{*1, *7, *9}	NORM_AUTO: 0.2 sec, NORMAL: 1 sec, MID: 2 sec, HIGH1: 5 sec, HIGH2: 20 sec, HIGH3: 75 sec	
Warm-up time	Minimum 1 hour (After warming up, optical alignment adjustments required.)	

*1: Horizontal scale: Wavelength display mode.
 *2: With 9.5/125 μ m single mode fiber with a PC type connector, after 1 hour of warm-up, after optical alignment with built-in reference light source or a single longitudinal mode laser (wavelength 1520 to 1560 nm, peak level ≥ -20 dBm, level stability ≤ 0.1 dBpp, and wavelength stability $\leq \pm 0.01$ nm).
 *3: Vertical scale: Absolute power display mode, Resolution setting: ≥ 0.05 nm, Resolution correction: OFF.
 *4: With 9.5/125 μ m single mode fiber (B1.1 type defined on IEC60793-2, PC polished, mode field diameter: 9.5 μ m, NA: 0.104 to 0.107).
 *5: After wavelength calibration with built-in reference light source or a single longitudinal mode laser (wavelength 1520 to 1560 nm, peak level ≥ -20 dBm and absolute wavelength accuracy ± 0.003 nm).

*6: Temperature condition changes to 23 $\pm 3^\circ$ C at 0.05 nm resolution setting.
 *7: High dynamic mode: OFF, Pulse light measurement mode: OFF, Resolution correction: OFF.
 *8: 1523 nm, High dynamic mode: SWITCH, Resolution correction: OFF
 *9: Span: ≤ 100 nm, Number of sampling: 1001, Average number: 1.
 *10: With He-Ne laser (1523 nm), 0.1 nm resolution setting, 1520 nm to 1620 nm except for peak wavelength ± 2 nm.
 *11: Option.
 "Typical" or "typ." in this document means "Typical value", which is for reference, not guaranteed specification.

Short wavelength model **AQ6373B**

Short Wavelength OSA 350 to 1200 nm



Applications

- Active optical device (semiconductor laser, fiber laser, LED)
- Passive active device (filter, FBG, special optical fiber)
- Support for the development of optical devices
 - Medical and biological applications (medical laser treatment, DNA analysis, laser microscope)
 - Industrial equipment (laser processing, laser marking)
 - Home electronics (laser projector, next-generation optical disc, LED products)
 - Measurement (LIDAR, interferometer)
 - Communication (plastic optical fiber (POF) communication)

Visible LED Test

The optical spectrum of visible LEDs used in a wide variety of applications such as lighting, indication, and measurement can be measured and analyzed. By supporting the large core fiber input, the AQ6373B can efficiently acquire the LED light and measure its spectrum. The standard built-in color analysis function automatically evaluates a dominant wavelength and XYZ color coordinates.

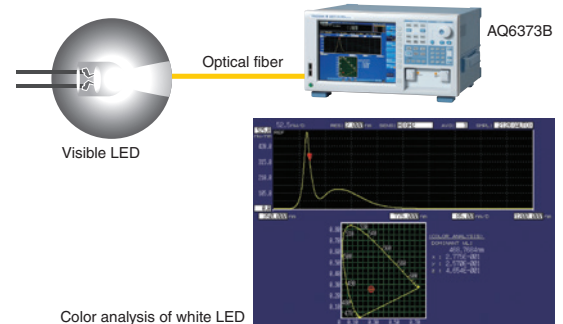

- Wavelength accuracy: ± 0.05 nm
- Wavelength resolution setting: 0.02 to 10 nm (Settable to 0.01 nm at 400 to 470 nm)
- Max. safe input power: +20 dBm
- Level sensitivity: -80 dBm
- Dynamic range: ≥ 60 dB
- Single-mode, multimode, and large-core fibers
- Built-in optical alignment source
- Automatic wavelength calibration with an external source
- Data logging function
- Built-in color analysis function for VIS



Example of 405 nm FP-LD measurement (Resolution setting: 0.01 nm)

Higher resolution measurement is possible in 400 to 470 nm range.

Main Specifications

Item	Specifications
Wavelength range *1	350 to 1200 nm
Span *1	0.5 nm to 850 nm (full span), and 0 nm
Wavelength accuracy *1	± 0.05 nm (633 nm), ± 0.20 nm (400 to 1100 nm) (after wavelength calibration with 633 nm He-Ne laser)
Wavelength resolution setting *1, *2	0.02, 0.05, 0.1, 0.2, 0.5, 1, 2, 5, 10 nm (full range), and 0.01 nm (400 to 470 nm)
Minimum sampling resolution *1	0.001 nm
Number of sampling points	101 to 50001, AUTO
Level sensitivity setting	NORM_HOLD, NORM_AUTO, NORMAL, MID, HIGH1, HIGH2 and HIGH3
High dynamic mode	SWITCH (sensitivity setting: MID, HIGH1 to 3)
Level sensitivity *3	-80 dBm (500 to 1000 nm), -60 dBm (400 to 500 nm, 1000 to 1100 nm) (Typical, Resolution setting: ≥ 0.2 nm, Averaging: 10 times, Sensitivity: HIGH3)
Maximum safe input power *3	+ 20 dBm (550 to 1100 nm), + 10 dBm (400 to 550 nm) (total input power)
Level accuracy *2	± 1.0 dB (850 nm, Input level: -20 dBm, Resolution: ≥ 0.2 nm, Sensitivity: MID, HIGH1 to 3, SMF [MFD5 μm @850 nm, NA0.14])
Level linearity *3	± 0.2 dB (Input level: -40 to 0 dBm, Sensitivity: HIGH1-3)
Dynamic range *1	60 dB (Peak ± 0.5 nm, Resolution: 0.02 nm, 633 nm, Sensitivity: HIGH1 to 3)
Applicable fiber	SM, GI (50/125 μm , 62.5/125 μm), Large core fiber (up to 800 μm)
Optical connector	FC type (optical input and calibration light source output)
Built-in calibration light source	Optical alignment light source (not equipped with wavelength reference light source.)
Sweep time *1, *4	NORM_AUTO: 0.5 sec, NORMAL: 1 sec, MID: 2 sec, HIGH1: 5 sec, HIGH2: 20 sec, HIGH3: 75 sec
Warm-up time	Minimum 1 hour (after warming up, optical alignment adjustment with built-in light source is required.)

Performance and functions can be limited by type of used fiber. The specifications are only guaranteed when a single mode fiber in which light travels in single mode at the measured wavelength is used. In the case in which the measured wavelength is less than the cut-off wavelength of the used fiber, or a multimode fiber is used, a measured spectrum may be inaccurate due to speckle noise. Please be careful especially when measuring high coherency sources like gas laser and laser diode.

*1: Horizontal scale: Wavelength display mode.

*2: Actual wavelength resolution varies according to the measured wavelength. Actual resolution at the 10 nm resolution setting is about 8 nm at most.

*3: Vertical scale: Absolute power display mode.

*4: High dynamic mode: OFF, Pulse light measurement mode: OFF, Number of sampling points: 1001, Average number: 1, Span: ≤ 100 nm excluding 450 to 470 nm and 690 to 700 nm.

Wide range model **AQ6374**

Wide range model covering the spectrum from visible to communication wavelengths



Applications

- Active device: semiconductor laser, LED, broadband light source etc.
- Passive device: fiber cable, optical coupler, FBG etc.

Loss wavelength characterization of optical fibers

The amount of the signal loss in a fiber is dependent on the propagation wavelength. Such dependency is caused by the typical absorption of optical fibers and by the effect of Rayleigh scattering. The material and type of fiber influence the loss values: in the case of a quartz single mode fiber, the loss around 1.55 μm is approx. 0.2 dB/km, which is the smallest reachable, while around 1.4 μm a bigger loss occurs due to water ions (OH). The loss wavelength characterization of this type of optical fiber requires measurements over a wide range of wavelengths.

In combination with a white light source, the AQ6374 efficiently measures the losses over a wide range of wavelengths. The loss value is displayed in terms of the loss per unit length of the optical fiber.

Features

- Wavelength range: 350 to 1750 nm
- Resolution setting: 50 pm to 10 nm
- Wide measurement level range: -80 to +20 dBm
- Close-in dynamic range: 60 dB
- Number of sampling: 100001
- High speed measurement
- Built-in light source for optical alignment and wavelength calibration
- Built-in cut filter for high order diffracted light
- Purge feature

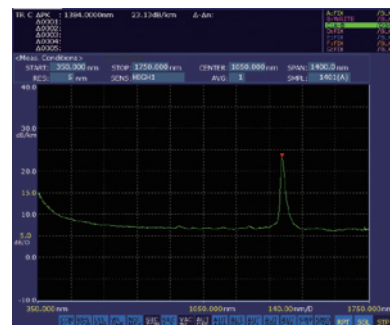

Measurement example of wavelength loss characterization

Main specifications

Items	Specifications
Wavelength range ^{*1}	350 to 1750 nm
Span ^{*1}	0.5 nm to 1400 nm (Full span), 0 nm
Wavelength accuracy ^{*1, *2, *5}	±0.05 nm (633 nm) (After wavelength calibration with 633 nm He-Ne laser.), ±0.05 nm (1523 nm), ±0.20 nm (Full range)
Wavelength repeatability ^{*1, *2, *5}	±0.015 nm (1 min.)
Wavelength resolution setting ^{*1, *2}	0.05, 0.1, 0.2, 0.5, 1, 2, 5 and 10 nm
Minimum sampling resolution ^{*1}	0.002 nm
Number of sampling	101 to 100001, AUTO
Level sensitivity setting	NORM_HOLD, NORM_AUTO, NORMAL, MID, HIGH1, HIGH2 and HIGH3
High dynamic mode	SWITCH (Sensitivity: MID, HIGH1-3)
Level sensitivity ^{*2, *3, *6}	-80 dBm (900 to 1600 nm), -70 dBm (400 to 900 nm) (Sensitivity: HIGH3)
Maximum safe input power ^{*2, *3}	+20 dBm (550 to 1750 nm), +10 dBm (400 to 550 nm) (Total input power)
Level accuracy ^{*2, *3, *4}	±1.0 dB (1550 nm, input level: -20 dBm, Sensitivity: HIGH1-3)
Level linearity ^{*2, *3}	±0.2 dB (Input level: -40 to 0 dBm, Sensitivity: HIGH1-3)
Polarization dependence ^{*2, *3, *4}	±0.15 dB (1550 nm)
Dynamic range ^{*1, *2}	60 dB (Peak ±1.0 nm, Resolution: 0.05 nm, 633 nm/1523 nm)
Applicable fiber	SM (9.5/125 μm), GI (50/125 μm, 62.5/125 μm), Large core fiber (up to 800 μm)
Optical connector	Optical input: AQ9447 (□□) Connector adapter (option) required. Calibration output: AQ9441 (□□) Universal adapter (option) required. (□□) Connector type FC or SC
Built-in calibration light source	Wavelength reference source (For optical alignment and wavelength calibration)
Sweep time ^{*1, *6, *7}	NORM_AUTO: 0.5 sec, NORMAL: 1 sec, MID: 2 sec, HIGH1: 5 sec
Warm-up time	Minimum 1 hour (After warming up, optical alignment adjustment with built-in light source required.)

^{*1}: Horizontal scale: Wavelength display mode.
^{*2}: With 9.5/125 μm single mode fiber, after optical alignment with built-in reference light source, when the purge gas is not used.
^{*3}: Vertical scale: Absolute power display mode, Resolution setting: ≥ 0.2 nm
^{*4}: With 9.5/125 μm single mode fiber (B1.1 type defined on IEC60793-2, PC polished, mode field diameter: 9.5 μm, NA: 0.104 to 0.107).
^{*5}: Resolution setting: 0.05 nm
^{*6}: Pulse light measurement mode: OFF.
^{*7}: Span: ≤ 100 nm (excluding 570 to 580 nm and 900 to 1080 nm), Number of sampling: 1001, Average number: 1.

Long wavelength model **AQ6375B/AQ6376**

The OSA for emerging applications in exNIR + MWIR regions

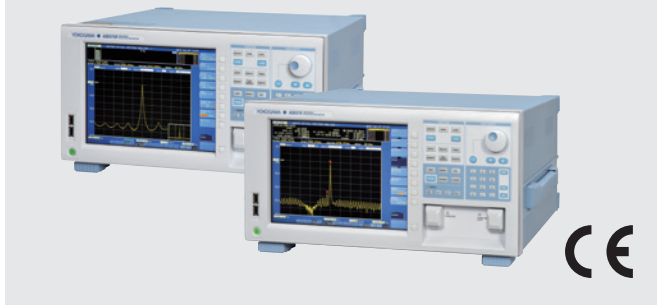

Features

- Unparalleled Performance
 - Wavelength range: 1200 to 2400 nm (AQ6375B)
1500 to 3400 nm (AQ6376)
 - Wavelength resolution setting: 50 pm to 2 nm (AQ6375B)
0.1 to 2 nm (AQ6376)
 - Wide measurement level range: -70 to +20 dBm (AQ6375B)
-65 to +13 dBm (AQ6376)
 - Close-in dynamic range: 55 dB
- Excellent Efficiency
 - High speed measurement
 - Fast command processing and data transfer
- Support Single-mode and Multimode Fibers
 - Free-space optical input
- Intuitive Easy Operation
 - Mouse & keyboard operation
 - Trace zoom function
- Easy Calibration
 - Built-in calibrator
- AQ6375&76 Viewer: Emulation/Remote control software (Optional)

■ Measurement Example

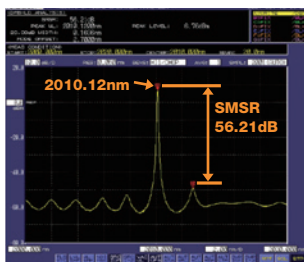

2010 nm DFB-LD with AQ6375B
(Res: 0.050 nm, Span: 20 nm)

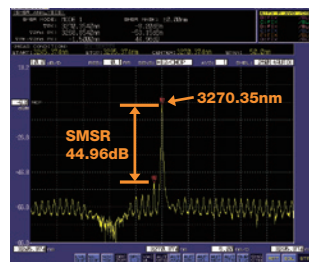

3270 nm DFB-LD with AQ6376
(Res: 0.1 nm, Span: 20 nm)

Main specifications

Items	Specifications	
	AQ6375B	AQ6376
Wavelength range *1	1200 to 2400 nm	1500 to 3400 nm
Span *1	0.5 nm to 1200 nm (Full span), 0 nm	0.5 nm to 1900 nm (Full span), 0 nm
Wavelength accuracy *1,*2,*5	±0.05 nm (1520 to 1580 nm), ±0.10 nm (1580 to 1620 nm), ±0.50 nm (Full range)	±0.50 nm (Full range)
Wavelength repeatability *1,*2	±0.015 nm (1 min.)	
Wavelength resolution setting *1,*2	0.05, 0.1, 0.2, 0.5, 1 and 2 nm	0.1, 0.2, 0.5, 1 and 2 nm
Minimum sampling resolution *1	0.002 nm	0.003 nm
Number of sampling	101 to 50001, AUTO	
Level sensitivity setting	NORM_HOLD, NORM_AUTO, NORMAL, MID, HIGH1, HIGH2 and HIGH3 (Only High dynamic mode (/CHOP) in HIGH1-3)	
Level sensitivity *2,*3,*6	-70 dBm (1800 to 2200 nm), -67 dBm (1500 to 1800 nm, 2200 to 2400 nm), -62 dBm (1300 to 1500 nm) (Sensitivity: HIGH3)*4	-65 dBm (1500 to 2200 nm), -55 dBm (2200 to 3200 nm), -50 dBm (3200 to 3400 nm) (Sensitivity: HIGH3)
Maximum input power *2,*3	+20 dBm (Per channel, full wavelength range)	+13 dBm (Per channel, full wavelength range)
Maximum safe input power *2,*3	+25 dBm (Total input power)	+20 dBm (Total input power)
Level accuracy *2,*3,*4,*8	±1.0 dB (1550 nm, input level: -20 dBm, Sensitivity: MID, HIGH1-3)	±1.0 dB (1550 nm, input level: -20 dBm, Sensitivity: HIGH1-3)
Level linearity *2,*3	±0.05 dB (Input level: -30 to +10 dBm, Sensitivity: HIGH1-3)	±0.2 dB (Input level: -30 to +10 dBm, Sensitivity: HIGH1-3)
Polarization dependence *2,*3,*8	±0.1 dB (1550 nm)	—
Dynamic range *1,*2	45 dB (Peak ±0.4 nm, Resolution: 0.05 nm), 55 dB (Peak ±0.8 nm, Resolution: 0.05 nm) (1523 nm, Sensitivity: HIGH1-3)	40 dB (Peak ±1 nm, Resolution: 0.1 nm), 55 dB (Peak ±2 nm, Resolution: 0.1 nm) (1523 nm, Sensitivity: HIGH1-3)
Applicable fiber	SM (9.5/125 μm), GI (50/125 μm, 62.5/125 μm)	
Optical connector	Optical input: AQ9447 (□ □) Connector adapter (option) required. Calibration output: AQ9441 (□ □) Universal adapter (option) required. (□ □) Connector type FC or SC	
Built-in calibration light source	Wavelength reference source (For optical alignment and wavelength calibration)	
Sweep time *1,*6,*7	NORM_AUTO: 0.5 sec, NORMAL: 1 sec, MID: 2 sec, HIGH1: 20 sec	
Warm-up time	Minimum 1 hour (After warming up, optical alignment adjustment with built-in light source required.)	

*1: Horizontal scale: Wavelength display mode.

*2: With 9.5/125 μm single mode fiber, after 2 hours of warm-up, after optical alignment with built-in reference light source, when the purge gas is not used.

*3: Vertical scale: Absolute power display mode, Resolution setting: ≥ 0.1 nm (AQ6375B)/ ≥ 0.2 nm (AQ6376).

*4: With 9.5/125 μm single mode fiber (B1.1 type defined on IEC60793-2, PC polished, mode field diameter: 9.5 μm, NA: 0.104 to 0.107).

*5: After wavelength calibration with built-in reference light source, Sampling resolution: ≤ 0.003 nm (AQ6375B)/AUTO (AQ6376), Sensitivity: MID, HIGH1-3

*6: Pulse light measurement mode: OFF.

*7: Span: ≤ 100 nm (The AQ6376 excluding 2200 to 2220 nm), Number of sampling: 1001, Average number: 1.

*8: Temperature condition changes to 23 ± 3°C at 0.1 nm resolution setting (AQ6375B only).

Long wavelength model **AQ6377**

The OSA for emerging applications in MWIR regions



Features

- Unparalleled Performance
 - Wavelength range: 1900 to 5500 nm
 - Wavelength resolution setting: 0.2 to 5 nm
 - Wide measurement level range: -60 to +13 dBm
 - Close-in dynamic range: 50 dB
- Excellent Efficiency
 - High speed measurement
 - Fast command processing and data transfer
- Support Single mode and large core fibers
 - Free-space optical input
- Intuitive Easy Operation
 - Mouse & keyboard operation
 - Trace zoom function
- Easy Calibration
 - Built-in calibrator
- AQ6377 Viewer: Emulation/Remote control software (Optional)

Applications

- Analyzing mid-infrared laser
 - Interband cascade laser (ICL)
 - Quantum cascade laser (QCL)
 - Fiber laser
 - Supercontinuum light sources (SC)

Measurement Example

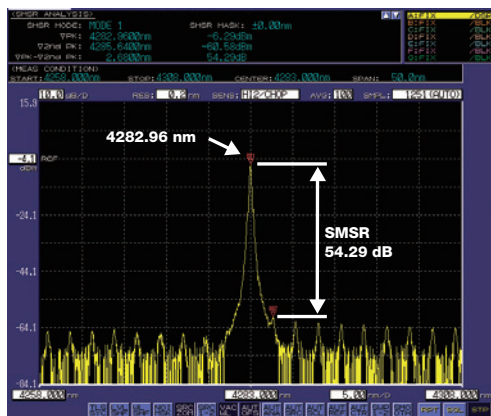

4.3 μm DFB laser
(Res: 0.2 nm, Span: 50 nm)

Main specifications

Items	Specifications
Wavelength range ^{*1}	1900 to 5500 nm
Span ^{*1}	1.0 nm to 3600 nm (Full span), 0 nm
Wavelength accuracy ^{*1, *2}	± 0.5 nm (Full range)
Wavelength resolution setting ^{*1, *2}	0.2, 0.5, 1, 2 and 5 nm
Minimum sampling resolution ^{*1}	0.01 nm
Number of sampling	101 to 50001, AUTO
Level sensitivity setting	NORM_HOLD, NORM_AUTO, NORMAL, MID, HIGH1, HIGH2 and HIGH3 (Only High dynamic mode (/CHOP) in HIGH1-3)
Level sensitivity ^{*3, *5, *6}	-40 dBm (1900 to 2200 nm), -50 dBm (2200 to 2900 nm), -60 dBm (2900 to 4500 nm) (Sensitivity: HIGH3)
Maximum input power ^{*3, *5, *6}	+13 dBm (Per channel, full wavelength range)
Maximum safe input power ^{*3, *5, *6}	+20 dBm (Total input power)
Level accuracy ^{*3, *4, *5, *6}	± 2.0 dB (2000 nm, input level: -10 dBm, Sensitivity: HIGH1-3, single mode fiber)
Dynamic range ^{*1, *2, *3}	50 dB (Peak ± 5 nm, Resolution: 0.2 nm, Sensitivity: HIGH1-3)
Applicable fiber	SM fiber, Large core fiber (up to 400 μm)
Optical connector	FC type (Optical input and Calibration output)
Built-in calibration light source	Wavelength reference source (For optical alignment and wavelength calibration)
Sweep time ^{*1, *6, *7}	NORM_AUTO: 0.5 s, NORMAL: 1 s, MID: 2 s, HIGH1: 20 s
Warm-up time	Minimum 1 hour (After warming up, optical alignment adjustment with built-in light source required.)

*1: Horizontal scale: Wavelength display mode.

*2: Single mode fiber, after 2 hours of warm-up, after optical alignment with built-in reference light source, when the purge gas is not used.

*3: Typical.

*4: Difference from Yokogawa's original standard device, with single mode fiber for 2 μm range.

*5: Vertical scale: Absolute power display mode, Resolution setting: ≥ 0.5 nm.

*6: Pulse light measurement mode: OFF

*7: Span: ≤ 100 nm (excluding 2200 to 2220 nm and 3900 to 3940 nm), number of sampling: 1001, average number: 1.

Optical Spectrum Analyzer **AQ6360**

Our fastest OSA optimized for optical device manufacturing

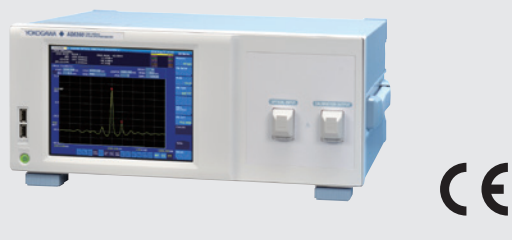

Applications

- SMSR measurement of LD chip and TOSA
- Optical transceiver, optical amplifier test

LD chip and TOSA

The AQ6360 delivers improvements in measurement throughput via a multimode fiber for free space laser beams from wafers, LD chip, TO CAN and TOSA measurements. This is due to the free space input structure of the OSA which accepts multimode fibers without high insertion loss, which occurs when multimode and single mode fibers are mismatched.

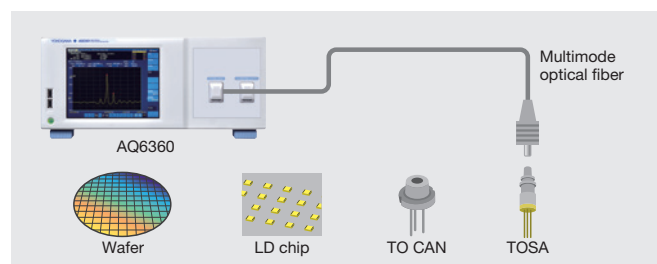

- **Ideal performance for manufacturing tests**

- Wavelength range: 1200 to 1650 nm
- Wavelength resolution: 0.1 to 2.0 nm
- High wavelength accuracy: ± 0.02 nm
- High dynamic range: 55 dB
- Wide measurement range: +20 to -80 dBm

- **Sweep up to two times faster**

The AQ6360 can sweep up two times faster than our models designed for R&D purposes.

- **Free space optical input**

- Accepts both single-mode and multimode optical fibers
- Accepts both flat and angle polished connectors

- **Built-in wavelength reference source (Factory option)**

- **Space saving 4U height**

- **Multi-touch touchscreen**

Main specifications

Items	Specifications
Applicable fiber	SM (9.5/125 μ m), GI (50/125 μ m, 62.5/125 μ m)
Wavelength range ¹	1200 to 1650 nm
Span ¹	0.1 to 450 nm (entire wavelength range), and 0 nm
Wavelength accuracy ^{1, 2, 4}	± 0.02 nm (1520 to 1580 nm), ± 0.04 nm (1580 to 1620 nm), ± 0.10 nm (1200 to 1650 nm)
Wavelength linearity ^{1, 2, 4}	± 0.02 nm (1520 to 1580 nm, 1580 to 1620 nm)
Wavelength repeatability ^{1, 2}	± 0.01 nm (1 min.)
Wavelength resolution setting ^{1, 2}	0.1, 0.2, 0.5, 1 and 2 nm
Wavelength resolution bandwidth accuracy ^{1, 2}	$\pm 5\%$
Minimum sampling resolution ¹	0.001 nm
Number of sampling points	101 to 50001, AUTO
Level sensitivity setting	NORM_HOLD, NORM_AUTO, NORMAL, MID, HIGH1, and HIGH2
Level sensitivity ^{2, 3}	-80 dBm (1300 to 1620 nm, sensitivity: HIGH2, resolution: 0.1 nm)
Maximum input power ²	+20 dBm (Input power per set wavelength resolution)
Maximum safe input power ²	+25 dBm (Total input power)
Level accuracy ^{2, 3}	± 0.5 dB (1310/1550 nm, -20 dBm, sensitivity: MID, HIGH1-2)
Level linearity ²	± 0.1 dB (Input level: -50 to +10 dBm, sensitivity: MID, HIGH1-2)
Level flatness ²	± 0.2 dB (1520 to 1580 nm, 1580 to 1620 nm)
Polarization dependence ²	± 0.1 dB (1550 nm)
Dynamic range ^{1, 2}	55 dB (Peak ± 0.4 nm), 40 dB (Peak ± 0.2 nm)(Resolution: 0.1 nm)
Optical return loss ⁵	35 dB (Typ., with angled-PC connector)
Optical input connector	FC or SC
Built-in calibration light source (option)	Wavelength reference source (For wavelength calibration)
Sweep time ^{1, 6}	NORM_AUTO: 0.2 s, NORMAL: 0.5 s, MID: 1 s, HIGH1: 2.5 s, HIGH2: 10 s
Warm-up time	Minimum 1 hour (After warm-up, the wavelength calibration is required.)
Electrical interface	GP-IB, Ethernet, USB, SVGA output
Remote control ⁷	GP-IB, Ethernet (TCP/IP), AQ6317 series compatible commands (IEEE488.1) and IEEE488.2
Data storage	Internal storage: 512 MBytes, external storage: USB storage (memory/HDD), file types: CSV (text), Binary, BMP, TIFF
Display ⁸	8.4-inch color LCD (Touchscreen, resolution: 800 \times 600 pixels)
Dimensions and weight	Approx. 426 (W) \times 177 (H) \times 459 (D) mm (excluding protector and handle), Approx. 15.5 kg
Power requirements	100 to 240 V AC, 50/60 Hz, approx. 100 VA
Environmental conditions	Performance guarantee temperature: +18 to +28°C, Operating temperature: +5 to +35°C, Storage temperature: .10 to +50°C, Humidity: 20 to 80%RH (no condensation)
Safety standards	EN 61010-1
	Laser ⁹ EN 60825-1: 2014, IEC 60825-1: 2007, GB 7247.1-2012 Class 1

"Typical" or "typ." in this document means "Typical value", which is for reference, not guaranteed specification.

¹: Horizontal scale: In the wavelength display mode

²: With 9.5/125 μ m single mode fiber with a PC type connector, after 1 hour of warm-up, sampling resolution ≤ 0.05 nm

³: With 9.5/125 μ m single mode fiber (B1.1 type defined on IEC60793-2, PC polished, mode field diameter: 9.5 μ m, NA: 0.104 to 0.107)

⁴: After wavelength calibration with built-in reference light source or a single longitudinal mode laser (wavelength 1520 to 1560 nm, peak level ≥ -20 dBm and absolute wavelength accuracy ± 0.003 nm).

⁵: With Yokogawa's master single mode fiber with an angled-PC connector. Typical 15 dB with PC connector.

⁶: Span: ≤ 100 nm, number of sampling: 1001, average number: 1

⁷: Some of AQ6317 series commands may not be compatible due to changes in specifications or functions.

⁸: There may be some pixels on the LCD that never light or are always lit (0.002% or less of the total number of pixels including RGB). These pixels are not defects.

⁹: When the built-in calibration light source is installed.

Optical Wavelength Meter **AQ6150 Series**

High performance and cost-effective Optical Wavelength Meter
Exceeding the testing needs of optical devices and transmission systems



Features

The AQ6150B & AQ6151B optical wavelength meters is an ideal instrument for accurately measuring the optical wavelength of optical devices and systems used in telecommunication applications from 900 to 1700 nm. By employing a Michelson interferometer and a high speed Fast Fourier Transform (FFT) algorithm, the AQ6150 series can measure not only a single wavelength laser signal but also a multiple wavelength laser signal from a DWDM system and Fabry-Perot laser.

- Wavelength Range: 1270 to 1650 nm, 1200 to 1700 nm, 900 to 1700 nm
- Wavelength accuracy: ±0.2 ppm (AQ6151B), ±0.7 ppm (AQ6150B)
- Simultaneous measurement of up to 1024 wavelengths
- Cope with modulated light and optical filter measurement
- Increase throughput with high speed measurement (≤0.2 sec)
- Reduce the lifetime ownership costs
- logging data function
- Add WDM (OSNR) analysis
- Abundant functions to increase work efficiency

Product Lineup

There are two models in the series. The High Accuracy AQ6151B model offers an accuracy of ±0.2 ppm to meet the most demanding precision requirements. The Standard Accuracy AQ6150B offers a ±0.7 ppm accuracy for applications with less demanding requirements at a more affordable price.

Model	Wavelength	Wavelength	Accuracy	Maximum number of wavelengths
Standard model AQ6150B	Standard	1270 to 1650 nm	±0.7 ppm (update rate: Normal, expect for 1200 to 1700 nm)	1024(-NW:Multi-wavelength) 1(-SW:Single-wavelength)
	Extended wavelength	1200 to 1700 nm		
	Wide range wavelength	900 to 1700 nm		
High accuracy model AQ6151B	Standard	1270 to 1650 nm	±0.2 ppm (update rate: Normal, expect for 1200 to 1700 nm)	1024(-NW:Multi-wavelength) 1(-SW:Single-wavelength)
	Extended wavelength	1200 to 1700 nm		
	Wide range wavelength	900 to 1700 nm		

Increase throughput with high speed measurement

Both models can acquire, analyze and transfer a measurement to a PC within 0.2 seconds. This vastly improves production throughput.



Various view modes

Multi wavelength view

Optical spectrum view

Other modes: Single wavelength view, Delta wavelength view, Grid view, and List view

Applications

- **WDM transmission systems**
 - Simultaneous measurement of multi channel and narrow spacing WDM system
 - Precise adjustment and inspection of laser sources
 - Measurement of modulated signals
- **Lasers / optical transceivers**
 - Precise adjustment and inspection of tunable lasers
 - Modulated signal measurement of optical transceivers and transponders.
 - Measurement of all channels of 25 G and 100 G optical transceivers with WDM technology.
- **Calibration of test systems**
 - Calibration of optical spectrum analyzers.
 - Calibration of DFB lasers for optical amplifier test system.
 - Calibration of tunable lasers for passive component test systems.

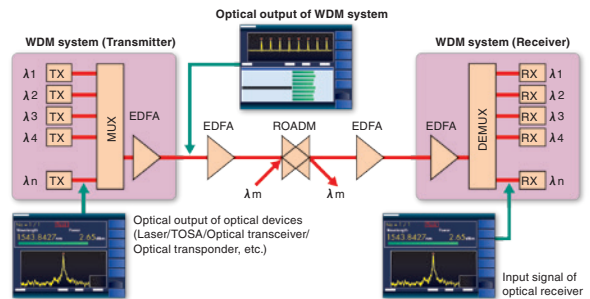

Specifications

Applicable optical fiber	SM (ITU-T G.652)
Wavelength range	1270 to 1650 nm, 1200 to 1700 nm, 900 to 1700 nm
Wavelength accuracy	AQ6150B: ±0.7 ppm (±1 pm at 1550 nm) AQ6151B: ±0.2 ppm (±0.3 pm at 1550 nm)
Min. resolvable separation	5 GHz (40 pm at 1550 nm)
Display resolution (Wavelength)	0.0001 nm
Power accuracy	±0.5 dB (1550 nm, -10 dBm)
Linearity	±0.3 dB (1550 nm, -30 dBm or higher)
Polarization dependency	±0.5 dB (1550 nm)
Display resolution (Power)	0.01 dB
Max. number of wavelengths	1024
Min. input power	-40 dBm (1270 to 1600 nm, single line input) -30 dBm (1600 to 1650 nm, single line input) +10 dBm (total of all lines) +18 dBm (total of all lines)
Max. input power	
Safe max. input power	
Return loss	35 dB
Measurement time	0.2 s or less (single measurement, update rate: Fast)
Display	5.7-inch color LCD (640 × 480 dots)
Data storage	Internal: 256 MB or more, External: USB
Interfaces	GP-IB, ETHERNET, USB, VGA output
Remote control	GP-IB, ETHERNET
Optical connector	FC/PC or SC/PC (AQ9441 Universal adapter)
Dimensions	Approx. 426 (W) × 132 (H) × 450 (D) mm
Mass	Approx. 11 kg

Please refer to the product brochure for details.

Model and Suffix Codes

Model	Suffix	Descriptions
AQ6150B		AQ6150B Optical Wavelength Meter
AQ6151B		AQ6151B Optical Wavelength Meter
Spec Code	-10	Standard type (1270 to 1650 nm)
	-20	Extended type (1200 to 1700 nm)
	-30	Wide range type (900 to 1700 nm)
Wavelength Detection	-SW	Single-wavelength type
	-MW	Multi-wavelength type
Optical input Connector	-FCC	FC/PC (AQ9441 Universal Adapter)
	-SCC	SC/PC (AQ9441 Universal Adapter)
Power Code	-D	UL/CSA standard and PSE compliant, 125 V
	-F	VDE/Korean standard, 250 V
	-R	Australian standard, 250 V
	-Q	British standard, 250 V
	-H	Chinese standard, 250 V
	-N	Brazilian standard, 250 V
-T	Taiwanese standard, 125 V	
-B	Indian standard, 250 V	

Multi Application Test System **AQ2200 Series**

Build Your Own Test Configurations in Small Footprint



Features

The AQ2200 Multi Application Test System is the ideal system for measuring and evaluating a wide range of optical devices and optical transmitters.

- Flexible and space effective
- Easy-to-View TFT color display
- Remote operation through Ethernet network
- Built-in applications
 - Optical power stability measurement
 - Short-term optical power fluctuation measurement
- Wide variety of plug-in modules
- Hot-swappable modules

Applications

- GE-PON ONU/OLT measurement system
- GE-PON optical three wavelength filter measurement
- Optical amplifier measurement system
- Optical transceiver measurement system
- Multicore fiber loss measurement

Frame and Module Lineup

- Frame controllers
 - AQ2211 Frame controller (3 slots for modules)
 - AQ2212 Frame controller (9 slots for modules)
- Light source modules
 - AQ2200-112 LS module (DFB, 1/2 channels)
 - AQ2200-131 Grid TLS module (C/L-band, 1 channel)
 - AQ2200-132 Grid TLS module (C/L-band, 2 channels)
- Sensor modules
 - AQ2200-215 Sensor module (+30 dBm, 970-1660 nm, 1-slot)
 - AQ2200-212 Sensor module (with analog output port, 800-1700 nm, 1-slot)
 - AQ2200-222 Dual sensor module (dual sensor, 800-1700 nm, 1 slot)
 - AQ2200-232 Optical sensor head (long wavelength)
 - AQ2200-242 Optical sensor head (short wavelength)
 - AQ2200-202 Interface module (2 channels)
- Optical attenuator modules
 - AQ2200-312 ATTN module [w/ Monitor output (optional)] (SMF/MMF, 1-slot)
 - AQ2200-332 ATTN module [w/ built-in monitor power meter] (SMF/MMF, 1-slot)
- Optical switch modules
 - AQ2200-411 OSW module (1 × 4/1 × 8, SMF/MMF, 1-slot)
 - AQ2200-412 OSW module (1 × 16, SMF, 2-slot)
 - AQ2200-421 OSW module (1 × 2/2 × 2, SMF/MMF, 1-slot)
- Modules for Optical Transceiver
 - AQ2200-642 Transceiver interface module (2-slot)



Transceiver Measurement System

The 10 Gbit/s optical transceiver modules such as XFP or SFP+ are frequently used in transmission systems and Ethernet systems. The measuring system for such modules requires many instruments including power supplies, multi-meters and the signal generators to control optical transceiver modules. The AQ2200 Multi Application Test System allows for building a space saving test system with a variety of plug-in modules.

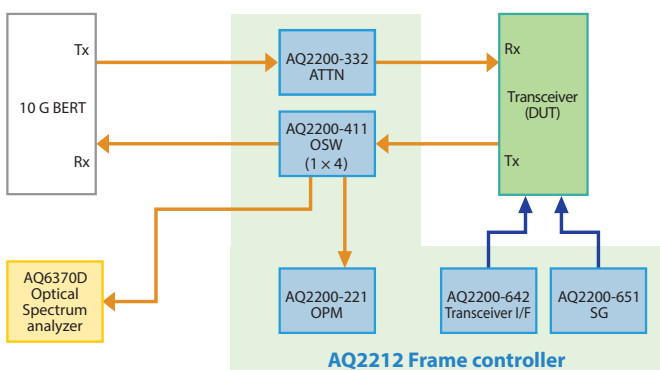

Optical Fiber Amplifier Measurement System

An optical fiber amplifier is an indispensable device for WDM transmission systems. This measurement system characterizes gains and noise figures (NF) of the fiber amplifier by measuring input light to an optical fiber amplifier, which was multiplexed using multiple light sources, as well as amplified output light with an optical spectrum analyzer. A high-power sensor allows for measuring total output power.

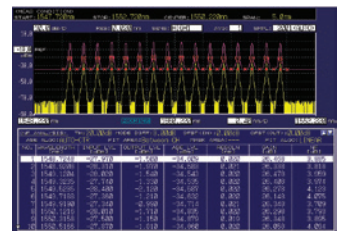

AQ6370D Measurement Screen

[Measurement items]
 • Gain, NF, and total output power

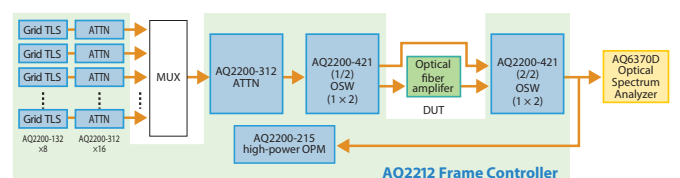

Optical Time Domain Reflectometer **AQ280 Series**



Model and Suffix Code

OTDR Mainframe

Models	Suffix codes	Descriptions
AQ280		AQ280 OTDR Mainframe
Language	-HJ	Japanese/English
	-HE	English (Multi language)
	-HM	Chinese
	-HC	Chinese/English
	-HK	Korean/English
	-HR	Russian/English
Options	/FST	Fiber Surface Test function
	/MNT	Monitoring function
	/SMP	Smart Mapper function
	/LAN	Ethernet
	/SB	Shoulder Belt

Standard accessories; Battery pack, hand belt, user's manual (CD-ROM), operation guide

AC adapter (Not included in AQ280. Please order separately.)

Models	Suffix codes	Descriptions
739874		AC Adapter ¹

¹: Used with power cord. Refer the bulletin of AQ280 OTDR for the select.

OTDR units

Models	Suffix codes	Descriptions
AQ282A		2WL 1310/1550 nm 38/36 dB
AQ283A		2WL 1310/1550 nm 42/40 dB
AQ284A		2WL 1310/1550 nm 46/45 dB
AQ285A		2WL 1310/1550 nm 50/50 dB
AQ283E		3WL 1310/1550, 1625 nm 42/40, 40 dB ⁴
AQ283F		3WL 1310/1550, 1650 nm 42/40, 40 dB ⁴
AQ283H		3WL 1310/1550/1625 nm 42/40/39 dB
AQ284H		3WL 1310/1550/1625 nm 46/45/44 dB
AQ282G		3WL 1310/1490/1550 nm 38/36/36 dB
AQ283K		4WL 1310/1490/1550/1625 nm 42/38/40/40 dB
AQ283J		4WL 1310/1383/1550/1625 nm 42/39/40/40 dB
AQ282M		2WL 850/1300 nm (MM) 25/27 dB
Optical connector	-USC	Universal Adapter (SC)
	-UFC	Universal Adapter (FC)
	-ULC	Universal Adapter (LC)
	-ASC	Universal Adapter (SC Angled-PC) ¹
	-NUA	No universal adapter
Options	/PC	Power Checker (Integrated optical power meter) ¹ , ²
	/SLS	Stabilized Light Source ³

¹: Not applicable to AQ282M

²: Not applicable to the Port2 of AQ283E and AQ283F

³: Not applicable to the wavelength 1383 nm of AQ283J.

⁴: The port for 1650 nm or 1625 nm is equipped with a built-in filter.

OPM/VLS modules

Models	Suffix codes	Descriptions	
AQ2780		OPM Module	
AQ2781		High Power OPM Module	
AQ2780V		OPM & VLS Module	
AQ2781V		High Power OPM & VLS Module	
	Optical connector	-SCC	Universal Adapter (SC)
		-FCC	Universal Adapter (FC)
-LMC		Ferrule Adapter (φ 1.25)	

Models	Suffix codes	Descriptions
AQ4780		VLS Module

Features

The AQ280 succeeds the high-end AQ2775 OTDR, which has been used for the installation and maintenance of a wide range of network systems, including core, metro, and access networks.

The AQ280 has a best-in-class 8.4-inch capacitive touchscreen that supports the same intuitive multi-touch functionality found in smartphones and other handheld devices, allowing users to reposition and resize objects on the screen. The AQ280 also has the same operation hard keys found on the preceding model. Users can opt to use either the touchscreen or the hard keys.

The AQ280 series offers remarkable flexibility and convenience with modular measuring units that can be replaced in the field. As new measuring units are developed to keep up with advances in optical technology, the AQ280 can be modified simply by replacing the measuring unit.

General Specifications

Display: 8.4-inch color TFT LCD Multi-touch capacitive touchscreen
 Power supply: AC adapter voltage 100 to 120 VAC or 200 to 240 VAC (auto switching) Battery(Li-ion) operation time 15 hours (Telcordia GR-196-CORE Issue 2). 10 hours (continuous measurement)

Electrical I/F: Unit interface × 1, Module interface × 1, USB 2.0 × 3, Ethernet × 1¹, SD card slot × 1

Dimensions: 287 mm (W) × 210 mm (H) × 80 mm (D)

Weight: Approx. 2.2 kg (OTDR mainframe)

*1 option

Application Software

Models	Suffix codes	Descriptions
AQ7933		AQ7933 OTDR Emulation Software
	-SP01	Download version (1 license)
	-SC01	Package version (1 license, 1 disc)
735071		AQ7940 Optical Fiber Monitoring Software (Ver. 5.01 or later)
	-HE	English
735050	-HJ	Japanese
		Additional option license for AQ280
	-FST	Fiber Surface Test function
	-MNT	Monitoring Function
	-SMP	Smart Mapper Function

Specifications by Model

OTDR unit	Number of wavelength	Dynamic range (dB)							Test application			Fiber network					
		SM 1310 (nm)	SM 1383 (nm)	SM 1490 (nm)	SM 1550 (nm)	SM 1625 (nm)	SM 1650 (nm)	MM 850 (nm)	MM 1300 (nm)	Installation	Maintenance		Core	Metro	Access	PON	MM fiber
AQ282A	2	38			36					●	●	●			●	●	
AQ283A	2	42			40					●	●	●			●	●	
AQ284A	2	46			45					●	●	●			●	●	
AQ285A	2	50			50					●	●	●			●	●	
AQ283E	3	42			40	40 ¹				●	●	●	●		●	●	●
AQ283F	3	42			40		40 ¹			●	●	●	●		●	●	●
AQ283H	3	42			40	39				●	●	○ ²	●		●	●	●
AQ284H	3	46			45	44				●	●	○ ²	●		●	●	●
AQ282G	3	38		36	36					●	●	●			●	●	●
AQ283K	4	42		38	40	40				●	●	○ ²			●	●	●
AQ283J	4	42	39		40	40				●	●	○ ²			●	●	●
AQ282M	2							25	27	●	●	●					●

¹: Port2, Built-in filter

²: Using an external filter

MFT-OTDR AQ1210 Series



Features

The AQ1210 is a latest model of MFT-OTDR.

The AQ1210 is a multifunctional handheld OTDR that combines all the necessary field test functions in one unit. It offers various functions, including an OTDR function that features short 50 cm event dead zone, a fault locator function that is effective in locating a fault, a loss test function that combines light sources and an optical power meter (option) in one unit, and a visible light source (option). You can also connect a fiber endface inspection probe. The AQ1210 retains the interface of the very popular AQ1200 or AQ7280 series. So you can use the variety of functions and the user-friendly interface.

Specifications

Items	Specifications							
Model	AQ1210A	AQ1215A	AQ1210E	AQ1215E	AQ1215F	AQ1216F	AQ1210D	
Wavelength (nm)	1310 ±20/1550 ±20		1310 ±20/1550 ±20, 1625 ±10	1310 ±20/1550 ±20, 1625 ±20	1310 ±20/1550 ±20, 1650 ±5	1310 ±20/1550 ±20, 1650 ±20	1310 ±20/1550 ±20, 850 ±15/1300 ±30	
Number of optical ports	1		2 (Port 2: 1625 nm, including a filter)		2 (Port 2: 1650 nm, including a filter)		2 (Port 2: 850/1300 nm)	
Applicable fiber	SM (ITU-T G.652)							
Distance range (km)	0.1 to 256	0.1 to 512	0.1 to 256	0.1 to 512			0.1 to 256, 0.1 to 100	
Pulse width (ns)	5 to 20000	3 to 20000	5 to 20000	3 to 20000			5 to 20000, 3 to 1000/3 to 5000	
Event dead zone (m)	0.75	0.5	0.75	0.5			0.75, 0.5	
Attenuation dead zone (m) (typ.)	4	2.5	4	2.5			4, 2.5	
PON dead zone (m) (typ.)	35	30	35	30			35, -	
Dynamic range (dB) (typ.)	37/35	42/40	37/35, 35	42/40, 39	42/40, 37	42/40, 40	37/35, 25/27	
Loss measurement accuracy	±0.05 dB/dB		±0.03 dB/dB	±0.05 dB/dB	±0.03 dB/dB		±0.05 dB/dB	
Optical connector	SC/FC/LC/SC Angled-PC (1310/1550/1625/1650 nm), SC/FC/LC (850/1300 nm)							
Light source function	Output power	-3 dBm ±1 dB					-3 dBm ±1 dB (1310/1550 nm), ≥-20 dBm (850/1300 nm)	
	Output power stability	±0.05 dB (1310 nm, 1550 nm), ±0.15 dB (1625 nm, 1650 nm)					±0.05 dB (1310/1550 nm), ±0.15 dB (850/1300 nm)	
	Modulation mode	CW, 270 Hz, 1 kHz, 2 kHz					CW, 270 Hz, 1 kHz, 2 kHz (1310/1550 nm), CW, 270 Hz (850/1300 nm)	
Laser class	Class 1M (EN 60825-1: 2007, GB 7247.1-2012), Class 1 (EN 60825-1: 2014) (1300/1310/1550/1625/1650 nm), Class 3R (IEC 60825-1: 2007, GB 7247.1-2012, EN 60825-1: 2014) (850 nm)							

Factory Installed Options

Optical Power Meter (/SPM, /HPM, /PPM)

Items	Specifications		
Model	Standard (/SPM)	High Power (/HPM)	PON (/PPM)
Wavelength setting	800 to 1700 nm		
Power range	CW	-70 to +10 dBm	-70 to +10 dBm (1310, 1490 nm), -50 to +27 dBm (1550 nm)
	CHOP	-70 to +7 dBm	-50 to +24 dBm
Noise level	0.5 nW (-63 dBm, 1310 nm)		0.5 nW (-63 dBm, 1310 nm), 50 nW (-43 dBm, 1550 nm)
Uncertainty	±5%		
Applicable fiber	SM (ITU-T G.652), GI (50/125 μm)		
Readout resolution	0.01 dB		

Power Checker (Integrated optical power meter) (/PC)

Items	Specifications
Wavelength setting	1310, 1490, 1550, 1625, 1650 nm
Power range	-50 to -5 dBm
Uncertainty	±0.5 dB

*Please check the brochure for details.

Model and suffix code

Model	Suffix	Descriptions
AQ1210A		2WL 1310/1550 nm 37/35 dB
AQ1215A		2WL 1310/1550 nm 42/40 dB
AQ1210E		3WL 1310/1550, 1625 nm 37/35, 35 dB ^{*1}
AQ1215E		3WL 1310/1550, 1625 nm 42/40, 39 dB ^{*1}
AQ1215F		3WL 1310/1550, 1650 nm 42/40, 37 dB ^{*1}
AQ1216F		3WL 1310/1550, 1650 nm 42/40, 40 dB ^{*1}
AQ1210D		4WL 1310/1550, 850/1300 nm 37/35, 25/27dB
Language	-HE	English (Multi-language)
	-HM	Chinese
	-HC	Chinese/English
	-HK	Korean/English
	-HR	Russian/English
Optical connector	-USC	Universal adapter (SC)
	-UFC	Universal adapter (FC)
	-ULC	Universal adapter (LC) ^{*2}
	-ASC	Universal adapter (SC Angled-PC) ^{*3}
	Options	Optical Power Meter (OPM) ^{*4}
	Power Checker ^{*4}	/PC Integrated optical power meter
	Visible Light Source ^{*4}	/VLS Optical connector: 2.5 mm diameter Ferrule type
	Fiber Surface Test function	/FST Pass/fail judgment
	Shoulder Belt	/SB

Standard accessories: Connecting cable for USB power adapter, hand belt, start-up guide

*1: The OTDR port for 1625 or 1650 nm is equipped with a built-in filter.

*2: 1.25 mm diameter Ferrule type for the optical power meter.

*3: When -ASC is selected, OTDR port is SC Angled-PC connector and OPM port is SC connector. For the AQ1210D, when -ASC is selected OTDR port 1 (SM) is -ASC, and OTDR port 2 (MM) is -USC.

*4: The options cannot be added after shipping.

Entry Level OTDR **AQ1000**

Good things come in small packages

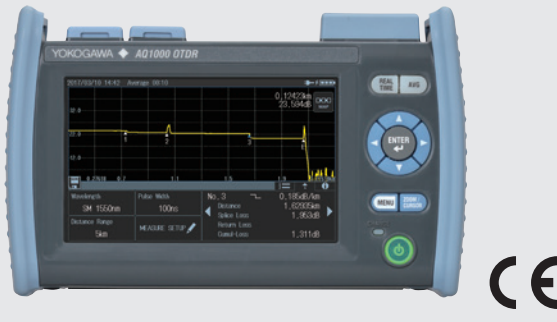

Specifications

OTDR

Items	Specifications
Wavelength (nm)	1310 ±20/1550 ±20
Applicable fiber	SM (ITU-T G.652)
Distance range (km)	0.2, 0.5, 1, 2, 5, 10, 20, 30, 50, 100, 200, 256
Pulse width (ns)	3, 10, 20, 30, 50, 100, 200, 300, 500, 1000, 2000, 5000, 10000, 20000
Sampling resolution	min. 5 cm
Number of sample points	max. 256000
Distance measurement accuracy (m)	±(1 m + Measurement distance × 2 × 10 ⁻⁵ ±1 sampling resolution)
Event dead zone (m)	≤ 0.8
Attenuation dead zone (m)	4/5
Dynamic range (dB)	32/30
Loss measurement accuracy	±0.03 dB/dB
Reflection accuracy	±2 dB
Laser class	Class 1M (EN 60825-1:2007, GB 7247.1-2012), Class 1 (EN 60825-1:2014)

Power checker (Integrated optical power meter)

Items	Specifications
Wavelength setting (nm)	1310/1490/1550/1625/1650
Measurement range (dBm)	-50 to -5
Measurement accuracy (dB)	±0.5

Stabilized light source

Items	Specifications
Wavelength (nm)	1310 ±25/1550 ±25
Optical output level	-3 dBm ±1 dB
Output power stability (dB)	±0.05
Modulation mode	CW, 270 Hz, 1 kHz, 2 kHz
Laser class	Class 1M (EN 60825-1:2007, GB 7247.1-2012), Class 1 (EN 60825-1:2014)

Visible light source (VLS)

Items	Specifications
Wavelength (nm)	650 ±20
Optical output level	-3 dBm or more (Peak)
Modulation mode	CW, 2 Hz
Laser class	Class 3R (EN 60825-1:2014, IEC 60825-1:2007, GB 7247.1-2012)

Features

This AQ1000 is specifically designed to increase the productivity of field personnel working on the installation and deployment of optical access networks such as Fiber To The Home (FTTH). Although it is positioned as an entry-level model, it still retains Yokogawa's established standards of quality/reliability and features characteristics which are usually present in higher-level models, such as a high-quality capacitive multi-touch touchscreen and wireless connectivity.

- Wavelengths: 1310/1550 nm
- Dynamic ranges: 32/30 dB
- Multi-touch touchscreen
- OTDR view modes: Trace view/Map view
- Long battery operation time
- Quick boot-up
- One-button measurement
- Measurements: Distance, Loss, Event search, Pass/Fail
- Built-in Power checker and Light Source, and VLS
- PDF reporting
- Wireless LAN
- USB power feeding

General Specifications

Items	Specifications	
Display	5.0 inch color TFT LCD WVGA Capacitive touchscreen	
External interfaces	USB2.0 × 2 Wireless LAN (/WLN option)	
Dimensions	185 mm (W) × 116 mm (H) × 56 mm (D)	
Weight	Approx. 660 g	
Environmental conditions	Temperature	Operating: -10°C to 50°C Storage: -20°C to 60°C
	Humidity	5 to 90% RH (No condensation)
	Altitude	4000 m or less
Power requirements	DC 5 V ±10%, max. 1.5 A	
Battery	Type	Lithium ion polymer
	Operating time	10 hours or more (Telcordia GR-196-CORE)
	Recharge time	5 hours (typical)

Model and Suffix Code

Model	Suffix codes	Descriptions
AQ1000		AQ1000 OTDR
Optical connector	-USC	Universal Adapter (SC)
	-UFC	Universal Adapter (FC)
	-ASC	Universal Adapter (SC Angled-PC)
Visible light source	/VLS	Visible Light Source
Wireless LAN*	/WLN	Wireless LAN

* The use of wireless LAN is subject to the regulation of each country. For more detail, please consult with our sales representatives.

Optical Power Meter **AQ2170**Optical Power Meter **AQ2180**Optical Light Source **AQ4280**

Features

Due to the increase in broadband services such as FTTH (Fiber To The Home), the communication carriers are reinforcing the infrastructure of optical fiber networks. In the introductory period of such networks, there is a strong need for handy OPM/LS for installation and maintenance together with OTDRs. the AQ2170, AQ2170H, AQ2180 and AQ2180H Optical Power Meters, and the AQ4280A, AQ4280B and AQ4280C Optical Light Sources to address installation and maintenance needs.

Specifications by model

Optical Power Meter

Model	AQ2170	AQ2170H	AQ2180	AQ2180H
Wavelength Setting	850/1300/1310/1490/1550/1625/1650 nm	1310/1490/1550/1625/1650 nm	850/1300/1310/1490/1550/1625/1650 nm	1310/1490/1550/1625/1650 nm
Photo Detector	InGaAs		InGaAs	
Optical Fiber	SM (ITU-T G.652), GI (50/125 μm), GI (62.5/125 μm) In fiber	SM (ITU-T G.652) In fiber	SM (ITU-T G.652), GI (50/125 μm), GI (62.5/125 μm) In fiber	SM (ITU-T G.652) In fiber
Optical Connector	FC, SC, LC, ferrule 2.5 mm dia, ferrule 125 mm dia (Standard)		FC, SC, LC, ferrule 2.5 mm dia, ferrule 125 mm dia (Standard)	
Power Range	-70 to +10 dBm	-50 to +26 dBm	-70 to +10 dBm	-50 to +26 dBm
Noise Level	-60 dBm	-40 dBm	-60 dBm	-40 dBm
Uncertainty	±5%	±5%	±5%	±5%
Display Resolution	0.01 dB (> -60 dBm), 0.1 dB (-60 dBm)	0.01 dB (> -40 dBm), 0.1 dB (-40 dBm)	0.01 dB, 0.01 dBm, 0.0001 μW	
Unit	ABS value: dBm, mW, μW / Relative value: dB		ABS value: dBm, mW, μW / Relative value: dB	
Modulation	CW, CHOP (270 Hz, 1 kHz, 2 kHz)		CW, CHOP (270 Hz, 1 kHz, 2 kHz)	
Memory function	—		999 records	
I/O	—		USB-B (mini)	
Power Source	Four AAA Cell batteries		Two AA Cell batteries	
Battery life time	40 hours		40 hours	
Dimensions (mm) Weight	63 (W) × 116 (H) × 35 (D) approx.160 g		76 (W) × 153 (H) × 43 (D) approx.280 g	

Optical Light Source

Model	AQ4280A	AQ4280B	AQ4280C
Element	LD		
Fiber	SM (ITU-T G.652)		
Wavelength	1310/1550 ± 20 nm	1310/1550±20 nm, 1490±10 nm	1310/1550±20 nm, 1490/1625±10 nm
Spectral width	< 5 nm (1310 nm), < 10 nm (1550 nm)	< 5nm (1310 nm, 1490 nm), < 10nm (1550 nm)	< 5nm (1310 nm, 1490 nm, 1625 nm) < 10nm (1550 nm)
Output power level	-5 dBm ± 1 dB	-5 dBm ± 1 dB	-5 dBm ± 1 dB
Power stability (15 min)	< ± 0.05 dB	< ± 0.05 dB (1310/1550 nm) < ± 0.1 dB (1490 nm)	< ± 0.05 dB (1310/1550 nm) < ± 0.1 dB (1490/1625 nm)
Modulation	CW, CHOP (270 Hz, 1 kHz, 2 kHz)		
Power Source	Three AA Cell batteries		
Battery life time	25 hours		
Laser Class	Class 1 (EN 60825-1: 2014, IEC 60825-1: 2007, GB 7247.1-2012)		
Dimensions (mm) Weight	76 (W) × 153 (H) × 43 (D) approx.300 g		

Standard Accessory

AQ2170 Optical Power Meter

Connector adapter (FC, SC, LC, ferrule2.5, ferrule 1.25), Four AAA Cell batteries, Carrying pouch, Protector, Operation Guide, User's Manual (CD)



AQ2180 Optical Power Meter

Connector adapter (FC, SC, LC, ferrule2.5, ferrule 1.25), Two AA Cell batteries, Carrying pouch, Protector, Operation Guide, User's Manual (CD)



AQ4280 Optical Light Source

Universal adapter (FC/PC, SC/PC, ST/PC Standard), Two AA Cell batteries, Carrying pouch, Protector, Operation Guide, User's Manual (CD)



MFT-OLTS AQ1100 Series



Model and Suffix Codes

Model	Suffix codes	Description
AQ1100A		LS: 1310/1550 nm
AQ1100B		LS: 1310/1550/1625 nm
AQ1100D		LS: MM850/1300, SM1310/1550 nm
Language	-HJ	Japanese/English
	-HE	English
	-HC	Chinese/English
	-HK	Korean/English
	-HR	Russian/English
Power cord	-D	UL/CSA standard, 125 V
	-F	VDE standard, 250 V
	-R	Australian standard, 250 V
	-Q	BS, Singapore standard, 250 V
	-H	Chinese standard, 250 V
	-P	Korean standard, 250V
Optical power meter	-SPM	Optical power meter
	-HPM	High power optical power meter
	-PPM (AQ1100A only)	PON Optical power meter
Optical connector	-USC	SC type (LS port, and OPM port)
	-UFC	FC type (LS port, and OPM port)
	-ULC	LC type (LS port, and OPM port for -PPM), 125 mm dia adapter(OPM port for -SPM and -HPM)
	-ASC (except AQ1100D)	SC/Angle-PC type (LS port, and OPM port for -PPM), SC type (OPM port for -SPM and -HPM)
Factory installed options	/VLS	Visible light source, optical connector: 2.5 mm dia ferrule
	/LAN	Ethernet (10/100BASE-TX)
	/SB	Shoulder belt

* For the US and the countries that require CE marking.
 ■ Standard Accessories
 Power cord, AC adapter, battery pack, hand belt, user's manual (CD-ROM), operation guide

General Specifications

The AQ1100 is an optical loss test set combining an optical power meter and light sources in one unit. An optical power meter is a measuring instrument usually used for optical loss tests. The AQ1100 supports up to MM850/1300 nm and SM1310/1550/1625 nm. Also, you can select a +27 dBm high power optical meter. For the light source, three models are available depending on the wavelength and fiber type used. For the optical power meter, you can select from three models depending on the measurement power and the purpose of the optical power meter.

Features

- Display: 5.7-inch color LCD (640 × 480)
- Loss test mode (only with /SPM or /HPM): Auto loss test, Loopback test, Multi-core loss test
- External interface: USB1.1 Type A and Type B (mini) × 1
- Power supply: AC adapter voltage 100 to 120 VAC or 200 to 240 VAC (auto-switching)
- Battery (Li-ion) operation time 6 hours and charging time 5 hours
- External dimensions: Approx. 217.5 mm (W) × 157 mm (H) × 74 mm (D)
- Weight: Approx. 1 kg or less (including internal battery)

Optional Accessories

Model	Suffix codes	Description
SU2006A		Soft carrying case
735480 (For optical power meters)	-SCC	Connector adapter (SC)
	-FCC	Connector adapter (FC)
735481	-LMC	Ferrule adapter (125 mm dia)
	-SCC	Universal adapter (SC)
SU2005A (For LS and PON optical power meter)	-FCC	Universal adapter (FC)
	-LCC	Universal adapter (LC)
	739874 (AC adapter)	-D
-F		VDE standard, 250 V
-R		Australian standard, 250 V
-Q		BS, Singapore standard, 250 V
-H		Chinese standard, 250 V
-P		Korean standard, 250V
-T		Taiwanese standard, 125 V
-N		Brazilian standard, 250 V
739882		
B8070CY		Shoulder belt

Specifications by Model

Models	AQ1100A	AQ1100B	AQ1100D
Wavelength (nm) *1	1310/1550 ± 25	1310/1550/1625 ± 25	1310/1550 ± 25 (SM) 850/1300 ± 30 (GI)
Light emitting device	LD	LD	LD(SM), LED(GI)
SM (LD) spectral width (nm) ** *2	<5 / <10	<5 / <10 / <10	<5 / <10
GI (LED) spectral width (nm) ** *3 (FWHM)	-	-	40(typ)/140(typ)
Optical output level (dBm)	-3 ± 1	-3 ± 1	SM: -3 ± 1 GI: -20 ± 1
Level stability (dB) **	±0.05	±0.05	SM: ±0.05 GI: ±0.1
Modulation mode	CW, CHOP(270 Hz, 1 kHz, 2 kHz) *5		
Applicable fiber	SM (ITU-T G.652)		SM (ITU-T G.652)GI (50/125 μm)
Optical connector	SC, FC, 1.25 mm dia ferrule, SC/Angled-PC		SC, FC, 1.25 mm dia ferrule
Laser class	Class 1 (EN 60825-1: 2014, IEC 60825-1: 2007, GB 7247.1-2012)		

Factory Installed Options		
Visible light source (VLS)	Optical connector	2.5 mm dia ferrule type
	Wavelength and optical output level	650 nm ± 20 nm, peak value -3 dBm or more
	Modulation frequency	Approx. 2 Hz
LAN interface (/LAN)	Laser class	Class 3R (EN 60825-1: 2014, IEC 60825-1: 2007, GB 7247.1-2012)
	10BASE-T/100BASE-TX RJ-45 connector	Ping test, PC remote control

Optical Power Meter Performance and Functions			
	Standard (/SPM)	High power (/HMP)	PON (/PPM)
Wavelength setting	Simple mode: 850/1300/1310/1490/1550/1625/1650 nm Detail mode setting range: 800 nm to 1700 nm, 1 nm step CWDM mode setting range: 1270 nm to 1610 nm 20 nm step		1310/1490/1550 nm (1490 nm and 1550 nm can be measured separately)
Applicable fiber	SM (ITU-T G.652) GI (50/125 μm)		
Power range (dBm)	-70 to +10 (CW) -70 to +7 (CHOP)	-50 to +27 (CW) -50 to +24 (CHOP) *6	-70 to +10: 1310/1490 nm -50 to +27: 1550 nm
Noise level	0.5 nW (-63 dBm, 1310 nm)	50 nW (-43 dBm, 1310 nm)	0.5 nW(-63 dBm, 1310 nm) 50 nW(-43 dBm, 1550 nm)
Uncertainty under standard conditions **	±5%	±5%	±0.5 dB (10%)
Readout resolution	0.01		
Level unit	Absolute: dBm, mW, μW, nW, Relative: dB		
Modulation mode	CW CHOP(270/1 k/2 kHz)	CW CHOP(270/1 k/2 kHz)	CW
Average function	1, 10, 50 and 100 times		
Logging function	Measurement intervals: 500 ms, 1 s, 2 s, 5 s, 10 s, Measurement count: 10 to 1000		

The specifications are at 23°C ± 2°C unless otherwise noted.
 *1: 23°C ± 2°C, CW
 *2: RMS (2σ, -20 dB)
 *3: Envelope (-3 dB)
 *4: for 15 minutes at a constant temperature within 23°C ± 2°C
 *5: CW and 270 Hz only at 850 nm and 1300 nm
 *6: Except for 850 nm and 1650 nm.
 *7: 23°C ± 2°C, standard conditions (CW, 1310 nm, 100 μW, SMF), at 1550 nm for /PPM.
 *8: LD ON. (in screen save mode)

MFT-1/10GbE AQ1300 Series



General Specifications

Display: 5.7-inch color LCD (640 × 480)

External interface: USB1.1 Type A and Type B (mini), LAN (RJ-45) × 1

Power supply: AC adapter 100 to 240 V, 50 to 60 Hz

Battery (Li-ion) operation time 1 hour

External dimensions: 217.5 (W) × 157 (H) × 74 (D) mm

Weight: Approx. 1.3 kg (including internal battery)

Features

The AQ1300 series is a compact and lightweight Ethernet tester that is designed to improve both work efficiency and quality at the same time, with function optimized for the network path testing and maintenance of Ethernet networks up to 1G or 10G depending on model chosen.

Easy operation prevents operational errors and stabilizes work quality for routine tasks such as network path testing.

Powerful analysis functions help isolate failures during maintenance work.

The AQ1300 series has two models, AQ1300 and AQ1301 to choose from depending on the measurement interface and bit rate. You can choose the model suitable for your test needs.



Model and Suffix Codes

Model	Suffix Code	Description
AQ1301		AQ1301 MFT-1GbE
AQ1300		AQ1300 MFT-10GbE
Language	-HE	English
Power Cord	-D	UL/CSA standard, 125 V
	-F	VDE standard, 250 V
	-R	Australian standard, 250 V
	-Q	BS, Singapore standard, 250 V
	-H	Chinese standard, 250 V
	-P	Korean standard, 250V
	-T	Taiwanese standard, 125 V
Optical power meter ¹	/SPML	Standard Optical power meter
XFP module ^{1, 2}	/SR	10GBASE-SR XFP module
	/LR	10GBASE-LR XFP module
	/ER	10GBASE-ER XFP module
SFP module ²	/SX	1000BASE-SX SFP module
	/LX	1000BASE-LX SFP module
RFC2544 ³	/BM	RFC2544 Function
Shoulder belt	/SB	Shoulder belt

¹: Cannot be specified for the AQ1301

²: For the SFP and XFP modules, be sure to use the modules listed above.

If you use other than an SFP or XFP module from Yokogawa, the functionality and performance of this product are not guaranteed. Furthermore, the warranty will be void.

³: Cannot be specified for the AQ1301 (this option is available for the AQ1300 as standard)

Optional Accessories

Model	Suffix codes	Description	
735454		Optical transceiver module	
	-SR ⁴	10GBASE-SR XFP module	
	-LR ⁴	10GBASE-LR XFP module	
	-ER ⁴	10GBASE-ER XFP module	
	-SX	1000BASE-SX SFP module	
	-LX	1000BASE-LX SFP module	
739882		Battery pack (reserve)	
SU2006A		Soft carrying case	
739874		AC Adapter	
	Power cord	-D	UL/CSA standard, 125 V
		-F	VDE standard, 250 V
		-R	Australian standard, 250 V
		-Q	BS, Singapore standard, 250 V
		-H	Chinese standard, 250 V
		-P	Korean standard, 250V
		-T	Taiwanese standard, 125 V
		-N	Brazilian standard, 250 V
		B8070CY	
735480 ⁴		-SCC	SC connector adapter for optical power meters
	-FCC	FC connector adapter for optical power meters	
735481	-LMC	125 mm dia connector adapter for optical power meters	
	-SFC	2.5 mm dia connector adapter for optical power meters	

⁴: Cannot be used with the AQ1301.

Specifications

Item	Specifications	
Interface	RJ-45	10BASE-T, 100BASE-TX, 1000BASE-T
	SFP	1000BASE-SX, 1000BASE-LX
	XFP ⁷	10GBASE-SR, 10GBASE-LR, 10GBASE-ER
Measurement function	Measurement menu	Auto, Auto (Remote), Manual, OPM (Optical power meter) ⁸
	Measurement mode	TRAFFIC, QoS, PING, Loop Back, BERT
	RFC2544	Throughput, Latency, Frame loss rate, Back-to-Back, Packet Jitter
Transmission function	Frame length	48 to 9999 bytes
	QoS transmission	Up to 8 channels (up to 4 ch in Auto and Auto (remote) mode)
Receive function	Receivable frame length	48 to 9999 bytes (Minimum IFG: 5 bytes)
	Latency time measurement resolution	100 ns
Loop back function	Field swap	DA/SA of MAC address, DA/SA of IP address, Dst/Src port of TCP/UDP
Remote control function	In-band remote	Remote test synchronization, Remote test start synchronization, Opposite tester automatic search(*), Opposite tester automatic addressing (* (*: Applicable only within a segment)
Layer-1 measurement function	Receiving clock measurement	Measurement range: -100 to +100 ppm Measurement resolution: 0.1 ppm
	LFS generation ⁹	Manual: Continuous transmission (Start/Stop), Auto: When a link down or LF is received, RF is transmitted automatically.

⁷: Only available for the AQ1300 ⁸: Only available for the AQ1300 (option) ⁹: When the interface is XFP (10 G)

Pressure Calibrator **CA700**

High Accurate and High Functional Pressure Calibrator Specially Designed for the Calibration of Differential Pressure and Pressure Transmitters.



CA700

Detailed catalog: Bulletin CA700-EN

Features

- Basic accuracy: Pressure (measurement) 0.01% rdg
Current (source/measurement) 0.015% rdg
Voltage (source/measurement) 0.015% rdg
- Widest range and highest resolution in class achieved
200 kPa gauge pressure model (resolution 0.001 kPa)
1000 kPa gauge pressure model (resolution 0.01 kPa)
3500 kPa gauge model (resolution 0.01 kPa)
- DC mA signals can be measured by supplying power to the transmitter from a 24V DC power supply.
- Calibration procedures of pressure transmitters and pressure switches are embedded.
“As Found”, “As Left” data and error rate (%) can be recorded.
- IP54 dustproof and waterproof robust case enables use in harsh environments.
- HART and BRAIN communication resistance is embedded.
- Pressure calibration in the high pressure range is possible with external pressure sensor PM100 connection.
- Dimensions: Approx. 264 (W) × 188 (H) × 96 (D) mm
Weight: Approx. 2 kg (including 6 AA size batteries)

Main Specifications

Pressure Measurement

Model	CA700-E-01	CA700-E-02	CA700-E-03
Pressure type	Gauge		
Measurement range	Positive pressure 0 to 200 kPa Negative pressure -80 to 0 kPa	Positive pressure 0 to 1,000 kPa Negative pressure -80 to 0 kPa	Positive pressure 0 to 3,500 kPa Negative pressure -80 to 0 kPa
Measurement display range	Up to 240,000 kPa	Up to 1,200.00 kPa	Up to 4,200.00 kPa
Measurement accuracy (6 months after calibration) (Tested after zero calibration)	Positive pressure 20 to 200 kPa: ±(0.01% of reading + 0.003 kPa) 0 to 20 kPa: ±0.005 kPa Negative pressure ±(0.2% of reading + 0.090 kPa)	Positive pressure ±(0.01% of reading + 0.04 kPa) Negative pressure ±(0.2% of reading + 0.08 kPa)	Positive pressure ±(0.01% of reading + 0.15 kPa) Negative pressure ±(0.2% of reading + 0.08 kPa)
Measurement fluid	Gas and liquid (non-corrosive, non-flammable, non-explosive, and non-toxic fluids)		
Pressure display units	kPa and other units (Pa, hPa, MPa, mbar, bar, atm, mmHg, inHg, g/cm ² , kgf/cm ² , mmH ₂ O@4°C, mmH ₂ O@20°C, ftH ₂ O@4°C, ftH ₂ O@20°C, inH ₂ O@4°C, inH ₂ O@20°C, Torr, psi)		
Input port	Rc 1/4 or 1/4 NPT female thread (selectable)		

Current and Voltage Measurement (common to all models)

DC current	0 to ±20,000 mA	±(0.015% of reading + 3 μA)
	0 to ±100.00 mA	±(0.015% of reading + 30 μA)
DC voltage	0 to ±5,000.0 V	±(0.015% of reading + 0.5 mV)
	0 to ±50,000 V	±(0.015% of reading + 5 mV)

24 V Loop power supply

Supply voltage	24 V ± 1 V	Load current 24 mA when communication resistance OFF
	24 V ± 6 V	Load current 20 mA when communication resistance ON

Current and voltage source (common to all models)

DC current*	0 to 20,000 mA	±(0.015% of setting + 3 μA)
DC voltage	0 to 5,000.0 V	±(0.015% of setting + 0.5 mV)

* External power supply for 20 mA SIMULATE: 5 to 28 V

Example of field calibration of differential pressure and pressure transmitter

Calibration of pressure transmitters is required to accurately measure the input and output values and to calculate the error rate. The CA700 ensures reliable calibration with its function to accurately measure the input and output values of pressure and current. Additionally its embedded calibration procedures enable users to perform certain calibration following the prescribed procedure.

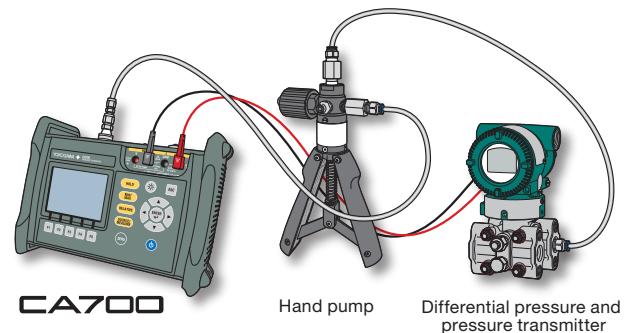

Hand Pump Series **91050/91055/91060**

Three High-Performance Hand Pump Models Available



Model 91050

Model 91055

Model 91060

Detailed catalog: Bulletin CA700-EN

Features

- Smooth pressurization with less internal leaking
- Strainer preventing debris from entering the pump included
- Low Pressure Hand Pump
Pressure generation range: -83 to 700 kPa
Ultra-compact hand pump
- Pneumatic Hand Pump
Pressure generation range: -83 to 4,000 kPa
High-performance small hand pump with a wide range of pressure generation
- Hydraulic Hand Pump
Pressure generation range: 0 to 70 MPa
High-performance hand pump capable of generating a pressure of up to 70 MPa

Product name	Model	Description of kit (individual models)
Hand Pump Kit (Low pressure)	91050	Hand Pump (91051), Connector Set (91052), Case (93052)
Hand Pump Kit (Pneumatic)	91055	Hand Pump (91056), Connector Set (91057), Case (93053)
Hand Pump Kit (Hydraulic)	91060	Hand Pump (91061), Connector Set (91062), Case (93053)

External Pressure Sensor **PM100**

External Pressure Sensor PM100 (70 MPa Range)

Pressure measurement up to 70 MPa with the CA700!



Features

- The highest measurement accuracy in field type
Basic accuracy: 0.01% of reading
- The highest resolution in class
0.0001 MPa is achieved in each range
- Multi range (Three pressure ranges in one unit)
7 MPa/10 MPa/16 MPa (-05)
25 MPa/50 MPa/70 MPa/ (-06)

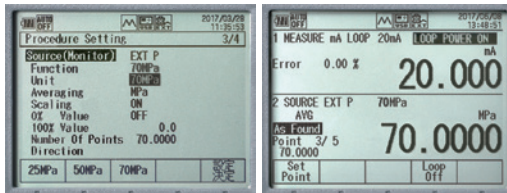

Setting screen

Measurement screen

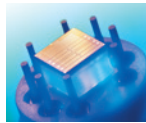

Silicon Resonant Sensor



PM100

CA700

Basic Specifications

16 MPa Model (-05)

Items	Specifications		
Pressure type	Shield gauge		
Measurement Range	0 to 7 MPa sg to 8.4000 MPa	0 to 10 MPa sg to 12.0000 MPa	0 to 16 MPa sg to 19.2000 MPa
Measurement display range			
Measurement accuracy*1, *2	6 th months after calibration (Test after zero calibration)*5 ± (0.01% of reading + 2 kPa)	± (0.01% of reading + 3 kPa)	± (0.01% of reading + 5 kPa)
	1 st year after calibration (Test after zero calibration)*5 ± (0.01% of reading + 2.8 kPa)	± (0.01% of reading + 3.8 kPa)	± (0.01% of reading + 5.8 kPa)
Allowable input	2.7 kPa abs to 23 MPa sg		
Temperature coefficient	± (0.001% of reading + 0.16 kPa) / °C or less		

70 MPa Model (-06)

Items	Specifications		
Pressure type	Shield gauge		
Measurement Range	0 to 25 MPa sg to 30.0000 MPa	0 to 50 MPa sg to 60.0000 MPa	0 to 70 MPa sg to 77.0000 MPa
Measurement display range			
Measurement accuracy*1, *2	6 th months after calibration (Test after zero calibration)*5 ± (0.01% of reading + 6 kPa)	± (0.01% of reading + 10 kPa)	± (0.01% of reading + 16 kPa)
	1 st year after calibration (Test after zero calibration)*5 ± (0.01% of reading + 9.5 kPa)	± (0.01% of reading + 13.5 kPa)	± (0.01% of reading + 19.5 kPa)
Allowable input	2.7 kPa abs to 98 MPa sg		
Temperature coefficient	± (0.001% of reading + 0.7 kPa) / °C or less		

Common Specifications

Items	Specifications
Resolution	0.0001 MPa (0.1 kPa)
Response time*6	2.5 s or less
Internal volume	Approx. 6 cm ³
Influence of positional setup	Zero point drift ±1 kPa or less
Measurement fluid	Gas and liquid (non-corrosive, non-flammable, non-explosive, and non-toxic fluids)
Measurement fluid temperature	-10 to 50°C (Liquid temperature 5 to 50°C)
Pressure sensor	Silicon resonant sensor
Pressure sensor element	Diaphragm
Input port	1/2 NPT female thread
Measurement unit material	Diaphragm: Hastelloy C276 and input port: SUS316

*1. Yokogawa's pressure standard accuracy is excluded *2. The value measured with the PM100 is in digital communication with the CA700, and there is no error between these instruments.

*3. 23°C±3°C, 6 months after calibration, Test after zero calibration *4. 23°C±3°C, 1 year after calibration, Test after zero calibration

*5. Zero-point calibration condition: Under atmospheric pressure *6. Time from 3.5 MPa to atmospheric release and from 0 MPa to ±3.5 MPa

General Specifications

Warm-up time	Approx. 5 minutes
Protection grade	IP54 dustproof and waterproof structure
Dimensions	Approx. 112 (W) × 75 (H) × 148 (D) mm
Weight	Approx. 1.2 kg
Conforming Standards	Safety: EN61010-1 (contamination class 2) EMC: EN61326-1 Class A, EN55011 Class A Group1
Operating temperature/humidity range	-10 to 50°C 20 to 80% (no condensation)
Storage temperature/humidity range	-20 to 60°C 20 to 80% (no condensation)
Accessories	Connection cable (1 m, Waterproof connector) (Common to PM100) 91083 (1/2" NPT male thread to 1/8" NPT female thread) (Common to PM100) 91084 (1/2" NPT male thread to 1/4" NPT female thread) (When -05 is selected) 91085 (1/2" NPT male thread to Rc 1/4" female thread) (When -05 is selected) 91086 (1/2NPT male thread to 1/4" NPT female thread) (When -06 is selected) 91087 (1/2" NPT male thread to Rc 1/4" female thread) (When -06 is selected)

PM100 External Dimensions

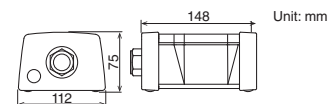

Unless otherwise specified, the dimensional tolerance is ±3% (but less than 10 mm is ±0.3 mm).

Applications

Field calibration of pressure transmitter

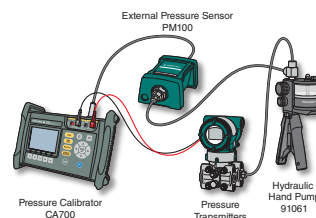

Multi Function Calibrator **CA500/550**



■ **Features**

- **High Accuracy**
 - CA550 0.010% (DCmA) /0.020% (Ω) /0.3°C (RTD)
 - CA500 0.015% (DCmA) /0.015% (Ω) /0.1°C (RTD)
- **Multi-function**
 - Sources and measures DC voltage, DC current, RTD, TC, resistance, frequency and pulse signals
 - Corresponds to 17 types of TC standard (JIS/IEC/DIN/ASTM/GOST R)
 - Corresponds to 14 types of RTD standard (JIS/IEC/GOST R)
- **Multiple source patterns**
 - Linear sweep function
 - Step sweep function
 - Program sweep function
- **Thin design × Robustness**
 - Thin body that is easy to hold with one hand, and improved robustness with protection



CA500/550 application examples

■ **20 mA SIMULATE**

The CA500 series can be used as a transmitter simulator to perform a loop test. It sinks the set current from an external voltage source of instrumentation equipment.

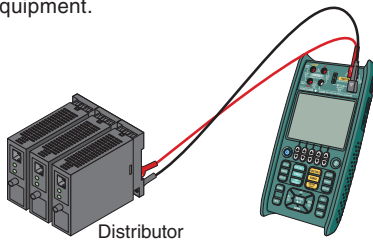

■ **Zero point adjustment of HART transmitter**

CA500 supports HART communication (Universal command/Common practice command). Reading of HART device information, writing of LRV/URV, and trimming of analog output are possible.

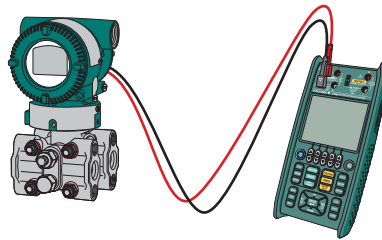

■ **RTD SIMULATE**

CA500/CA550 corresponds to 14 types of RTD for sourcing. It achieves the high basic accuracy of 0.1°C* (typical of type Pt100), which enables it to operate a highly reliable test. Additionally, input and output testing of temperature transmitters is possible at the same time.

*Accuracy for CA550

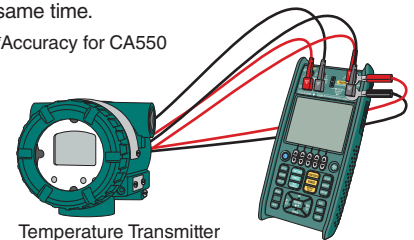

Calibrators

Easy-to-view Display

CA500 features a Reflective LCD, providing improved outdoor visibility. Main display (generated/measured values) and Sub display (% , mV, Ω, etc.) allow required information at a work site to be confirmed at a glance.



Wiring information display function

A wiring diagram is displayed according to the function selected.

This function allows a user to perform wiring while referring to a wiring diagram and prevents mis-wiring.



Thermocouple generation using TC Mini Plug

Using a TC Mini Plug together with a compensating lead wire enables generation of thermal electromotive force without an external RJ sensor.*

*A compensating lead wire needs to be prepared by customer.



Easy-to-use key operation

0%/100% keys

The source can be easily switched between 0% and 100% of range. Users can also set a desired value.



UP/DOWN keys

The output is changed in preset steps by pressing UP or DOWN key.

Operation key layout

Keys related to generation and measurement are arranged collectively to allow easy and intuitive operation.

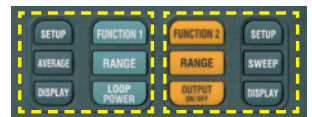

SQUARE ROOT output

For 4-20 mA, 1-5 V ranges, users can choose between LINEAR and SQUARE ROOT output.

	Current		Voltage	
	LINEAR	SQUARE ROOT	LINEAR	SQUARE ROOT
0%	4 mA	4 mA	1 V	1 V
25%	8 mA	5 mA	2 V	1.25 V
50%	12 mA	8 mA	3 V	2 V
75%	16 mA	13 mA	4 V	3.25 V
100%	20 mA	20 mA	5 V	5 V

Actual output values

CA550 Only

Automatic input/output testing (Program sweep)

Automatic input/output testing is possible by setting source values for each step for a calibration target. Calibration results such as generated value, measured value, error rate, date/time, and pass/fail are saved in CSV format in the CA550 main unit. By connecting the CA550 to a PC using a standard USB cable, the instrument can be recognized as a mass-storage device for data to be transferred to the PC.

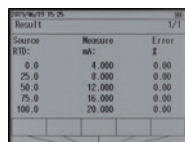
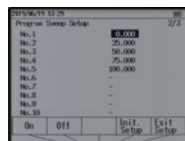

HART communication function¹ HART/BRAIN modem function¹ BRAIN TagNo acquisition function²

¹ when CA550-F2 or -F3 is specified. ² when CA550-F2 is specified.

The following items are supported by HART communication function:

• LOOP TEST	—	
• TagNo.	• PV value (including reading of PV %value, AO value, SV value, TV value, QV value)	Read
• LRV (Lower limit of range)	• Damping	Read and Write
• URV (Upper limit of range)		Write
• Trim D/A at 4 mA	• Trim D/A at 20 mA	• PV Zero

Please note that not all commands are supported by HART communication. TagNo acquisition function is available in BRAIN communication. No other functions are available.

Specifications

● Voltage/Current/Resistance/Pulse Source Unit

Function	Range	Resolution	Source range	Accuracy (1 year) ±(% of Setting + offset)		Note
				CA500	CA550	
DC voltage	100 mV	1 μV	±110.000 mV	0.015% + 10 μV	0.015% + 5 μV	Maximum output current: 10 mA
	1-5 V	0.1 mV	0.0000 to 6.0000 V	0.015% + 0.5 mV		Maximum output current: 10 mA Value output function supporting square root computation is available
	5 V	0.1 mV	±6.0000 V	0.015% + 0.5 mV		Maximum output current: 10 mA
DC current	30 V	1 mV	±33.000 V	0.015% + 5 mV		Maximum output current: 1 mA
	20 mA	1 μA	±24.000 mA	0.015% + 3 μA	0.010% + 2 μA	Source voltage: 0 to +20 V
	4-20 mA	1 μA	0.000 to 24.000 mA	0.015% + 3 μA	0.010% + 2 μA	Source voltage: 0 to +20 V Value output function supporting square root computation is available
Resistance	20 mA SIMULATE	1 μA	0.000 to 24.000 mA	0.015% + 3 μA	0.010% + 2 μA	External power supply: +5 to +28 V
	400 Ω	10 mΩ	0.00 to 440.00 Ω	0.020% + 0.1 Ω ¹	0.015% + 0.05 Ω ¹	Allowable measurement current: 0.1 to 3 mA
Resistance	4000 Ω	100 mΩ	0.0 to 4400.0 Ω	0.020% + 0.5 Ω ¹	0.015% + 0.2 Ω ¹	Allowable measurement current: 0.05 to 0.6 mA
	500 Hz	0.01 Hz	1.00 to 550.00 Hz	0.005% + 0.01 Hz		Square wave, 50% Duty Cycle, +0.1 to +15 V Pulse number: Continuous 1 to 99999 cycles Maximum load current: 10 mA
5000 Hz	0.1 Hz	1.0 to 5500.0 Hz	0.005% + 0.1 Hz			
50 kHz	0.001 kHz	0.001 to 50.000 kHz	0.005% + 0.001 kHz			
CPM	0.1/min	1.0 to 1100.0/min	0.5/min			

● 24 V Loop Power Supply

Supply voltage	Note
24 V±2 V	Communication resistance: OFF Maximum load current: 24 mA

● Voltage/Current/Resistance/Pulse Measurement Unit

Function	Range	Resolution	Measurement range	Accuracy (1 year) ±(% of reading + offset)		Note
				CA500	CA550	
DC voltage	100 mV	1 μV	±110.000 mV	0.015% + 10 μV	0.015% + 5 μV	Input resistance: 1 GΩ or more
	5 V	0.1 mV	±6.0000 V	0.015% + 0.5 mV		Input resistance: Approx. 1 MΩ
	50 V	1 mV	±55.000 V	0.015% + 5 mV		Input resistance: Approx. 1 MΩ
DC current	50 mA	1 μA	±60.000 mA	0.015% + 3 μA	0.010% + 2 μA	Input resistance: 10 Ω or less
Resistance	400 Ω	10 mΩ	0.00 to 440.00 Ω	0.020% + 0.1 Ω ^{2,3}	0.015% + 0.05 Ω ^{2,3}	Voltage applied current measurement method (typical 1 mA@0 Ω, 781 μA@400 Ω, 240 μA@4 kΩ)
	4000 Ω	100 mΩ	0.0 to 4400.0 Ω	0.020% + 0.5 Ω ^{2,3}	0.015% + 0.2 Ω ^{2,3}	
Pulse measurement ⁴	500 Hz	0.01 Hz	1.00 to 550.00 Hz	0.005% + 0.01 Hz		Measurement time: 1.0 s (Max. 10 s), 0.5 V to 30 Vpp
	5000 Hz	0.1 Hz	1.0 to 5500.0 Hz	0.005% + 0.1 Hz		
	50 kHz	0.001 kHz	0.001 to 50.000 kHz	0.005% + 0.001 kHz		
	PULSE COUNT	1	0 to 99999	2		Maximum integration time: 60 min, 0.5 V to 30 Vpp

Accuracy is guaranteed under the environmental conditions of +23°C±5°C, 20 to 80% RH. For use in the temperature range of -10 to +18°C or +28 to +50°C, add the temperature coefficient: 0.005% of Range/°C.

¹ When using the included binding post (99045) measuring.

² Above accuracy is defined for 4 wire measuring.

³ Accuracy for 3 wire measuring: 0.05Ω to 400 Ω range; 0.2 Ω to 4000 Ω range is added, on condition the resistance of all cables are the same.

⁴ Dry contact compatible

Calibrators

● Thermocouple (TC) Source/Meas (Terminal TC-A: TC plug terminal)

Accuracy of Source/Meas (Common to CA500/CA550)

t: Temperature of Source/Meas.

TC	Source/Meas Temperature Range	Source Accuracy [°C] (1 year) (±°C)	Meas. Accuracy [°C] (1 year) (±°C)	Standard or Regulation
K	-200.0 ≤ t < 0.0°C	0.5 + t × 0.30%	0.5 + t × 0.30%	IEC60584-1 ^{1,2}
	0.0 ≤ t < +500.0°C	0.5	0.5	
	+500.0 ≤ t ≤ +1372.0°C	0.5 + (t - 500.0) × 0.03%	0.5 + (t - 500.0) × 0.02%	
E	-250.0 ≤ t < -200.0°C	1.1 + (t - 200.0) × 2.00%	1.1 + (t - 200.0) × 2.00%	IEC60584-1 ^{1,2}
	-200.0 ≤ t < 0.0°C	0.5 + t × 0.30%	0.5 + t × 0.30%	
	0.0 ≤ t < +500.0°C	0.5	0.5	
J	+500.0 ≤ t ≤ +1000.0°C	0.5 + (t - 500.0) × 0.02%	0.5 + (t - 500.0) × 0.02%	IEC60584-1 ^{1,2}
	-210.0 ≤ t < 0.0°C	0.5 + t × 0.30%	0.5 + t × 0.30%	
	0.0 ≤ t ≤ +1200.0°C	0.5 + t × 0.02%	0.5 + t × 0.02%	
T	-250.0 ≤ t < -200.0°C	1.1 + (t - 200.0) × 2.50%	1.1 + (t - 200.0) × 2.50%	IEC60584-1 ¹
	-200.0 ≤ t < 0.0°C	0.5 + t × 0.30%	0.5 + t × 0.30%	
	0.0 ≤ t ≤ +400.0°C	0.5	0.5	
N	-200.0 ≤ t < 0.0°C	0.6 + t × 0.40%	0.6 + t × 0.30%	IEC60584-1 ¹
	0.0 ≤ t ≤ +1300.0°C	0.6	0.6	
L	-200.0 ≤ t < 0.0°C	0.5 + t × 0.15%	0.5 + t × 0.15%	DIN 43710 1985
	0.0 ≤ t ≤ +900.0°C	0.5	0.5	
U	-200.0 ≤ t < 0.0°C	0.5 + t × 0.20%	0.5 + t × 0.20%	DIN 43710 1985
	0.0 ≤ t ≤ +600.0°C	0.5	0.5	
	-20.0 ≤ t < 0.0°C	2.0	2.0	
R	0.0 ≤ t < +100.0°C	2.0	1.4	IEC60584-1 ^{1,2}
	+100.0 ≤ t ≤ +1767.0°C	1.4	1.4	
	-20.0 ≤ t < 0.0°C	2.0	2.0	
S	0.0 ≤ t < +100.0°C	2.0	1.4	IEC60584-1 ^{1,2}
	+100.0 ≤ t ≤ +1768.0°C	1.4	1.4	
	+600.0 ≤ t < +800.0°C	1.2	1.5	
B	+800.0 ≤ t < +1000.0°C	1.0	1.2	IEC60584-1 ^{1,2}
	+1000.0 ≤ t ≤ +1820.0°C	1.0	1.1	
	0.0 ≤ t < +1000.0°C	0.8	0.8	
C	+1000.0 ≤ t ≤ +2315.0°C	0.8 + (t - 1000.0) × 0.06%	0.8 + (t - 1000.0) × 0.06%	IEC60584-1 ¹
	-200.0 ≤ t < 0.0°C	0.4 + t × 0.20%	0.4 + t × 0.20%	
	0.0 ≤ t < +300.0°C	0.4	0.4	
XK	+300.0 ≤ t ≤ +800.0°C	0.5	0.5	GOST R 8.585-2001
	0.0 ≤ t < +1000.0°C	1.0	1.0	
	+1000.0 ≤ t ≤ +2500.0°C	1.0 + (t - 1000.0) × 0.06%	1.0 + (t - 1000.0) × 0.06%	
A	0.0 ≤ t < +300.0°C	1.4	1.8	IEC60584-1
	+300.0 ≤ t < +1500.0°C	1.2	1.2	
	+1500.0 ≤ t ≤ +2315.0°C	1.8	2.2	
D (W3Re/W25Re)	+100.0 ≤ t < +300.0°C	1.4	1.8	ASTM E1751/E1751M
	+300.0 ≤ t < +1500.0°C	1.2	1.2	
	+1500.0 ≤ t ≤ +2315.0°C	1.8	2.2	
G (W/W26Re)	0.0 ≤ t < +100.0°C	0.6	1.8	ASTM E1751/E1751M
	+100.0 ≤ t < +1000.0°C	0.8	1.8	
	+1000.0 ≤ t ≤ +1395.0°C	1.0	2.2	
PLATINELII	0.0 ≤ t < +500.0°C	10.0	11.0	ASTM E1751
	+500.0 ≤ t < +1000.0°C	3.0	4.0	
	+1000.0 ≤ t ≤ +1888.0°C	2.0	2.0	

Using internal reference junction compensation
Accuracy is guaranteed under the environmental conditions of 23°C±5°C, 20 to 80% RH. For use in the temperature range of -10 to +18°C or 28 to 50°C, add the temperature coefficient: 0.05°C/°C. Errors of TC are not included.
The display resolution for source/meas is 0.1°C
Terminal TC-B (reference junction compensation: off) Source/measurement accuracy 0.3°C (typical)

¹ Also compliant with JIS C 1602
² IPTS-68 (JIS C 1602 1981) may be selected.

About formula of accuracy
The accuracy of source or measuring is defined by constant value or formula of linear expression. Example) Accuracy of type K at measuring point of 1000.0°C is ±(0.5 + (1000.0 - 500) × 0.02%)°C = ±0.6°C

● RTD Source/Measure

t: Temperature of Source/Meas.

RTD	Coefficient	Temperature Range	Source/Meas. Accuracy (1 year) (± °C)		Allowable excitation current	Standard or Regulation
			CA500	CA550		
PT100	3851	-200.0 ≤ t < +100.0°C	0.3	0.1	0.1 to 3 mA	IEC60751 ¹⁾
		+100.0 ≤ t ≤ +800.0°C	0.3 + (t-100) × 0.033%	0.1 + (t-100) × 0.033%		
	3850	-200.0 ≤ t < +100.0°C	0.3	0.1	0.1 to 3 mA	JIS C 1604 1989 (Pt100)
		+100.0 ≤ t ≤ +630.0°C	0.3 + (t-100) × 0.033%	0.1 + (t-100) × 0.033%		
3916	-200.0 ≤ t < +100.0°C	0.3	0.1	0.1 to 3 mA	JIS C 1604 1989 (JPt100)	
	+100.0 ≤ t ≤ +510.0°C	0.3 + (t-100) × 0.033%	0.1 + (t-100) × 0.033%			
3926	-200.0 ≤ t < +100.0°C	0.3	0.1	0.1 to 3 mA	Minco Application Aid #18	
	+100.0 ≤ t ≤ +630.0°C	0.3 + (t-100) × 0.033%	0.1 + (t-100) × 0.033%			
PT200	3851	-200.0 ≤ t < +100.0°C	0.3	0.1	0.05 to 3 mA	IEC60751 ¹⁾
		+100.0 ≤ t ≤ +630.0°C	0.3 + (t-100) × 0.033%	0.1 + (t-100) × 0.033%		
PT500	3851	-200.0 ≤ t < +100.0°C	0.3	0.1	0.05 to 0.6 mA	IEC60751 ¹⁾
		+100.0 ≤ t ≤ +630.0°C	0.3 + (t-100) × 0.033%	0.1 + (t-100) × 0.033%		
PT1000	3851	-200.0 ≤ t < +100.0°C	0.2	0.1	0.05 to 0.6 mA	IEC60751 ¹⁾
		+100.0 ≤ t ≤ +630.0°C	0.2 + (t-100) × 0.033%	0.1 + (t-100) × 0.033%		
Cu10	427	-100.0 ≤ t ≤ +260.0°C	1.5	1.2	0.1 to 3 mA	Minco Application Aid #18
Ni120	627	-80.0 ≤ t ≤ +260.0°C	0.2	0.1	0.1 to 3 mA	Minco Application Aid #18
PT50	3851	-200.0 ≤ t < +100.0°C	0.4	0.2	0.1 to 3 mA	IEC60751 ¹⁾
		+100.0 ≤ t ≤ +630.0°C	0.4 + (t-100) × 0.033%	0.2 + (t-100) × 0.033%		
PT50G	—	-200.0 ≤ t < +100.0°C	0.4	0.2	0.1 to 3 mA	GOST R 8.625-2006
		+100.0 ≤ t ≤ +800.0°C	0.4 + (t-100) × 0.033%	0.2 + (t-100) × 0.033%		
PT100G	—	-200.0 ≤ t < +100.0°C	0.3	0.1	0.1 to 3 mA	GOST R 8.625-2006
		+100.0 ≤ t ≤ +630.0°C	0.3 + (t-100) × 0.033%	0.1 + (t-100) × 0.033%		
Cu50M	—	-180.0 ≤ t ≤ +200.0°C	0.4	0.2	0.1 to 3 mA	GOST R 8.625-2006
Cu100M	—	-180.0 ≤ t ≤ +200.0°C	0.3	0.1	0.1 to 3 mA	GOST R 8.625-2006

Accuracy is guaranteed under the environmental conditions of +23°C±5°C, 20 to 80% RH. For use in the temperature range of -10 to +18°C or +28 to +50°C, add the temperature coefficient: 0.05°C/°C.

Above accuracy is defined for 4 wire measuring. Accuracy for 3 wire measuring: 1.0°C to Cu 10; 0.6°C to Pt50/Pt50G/Cu50M; 0.3°C to other RTD is each added, on condition the resistance of all cables are the same. Accuracy for 2 wire measuring: Same with 3 wire measuring on condition the resistance of cables are excluded. The accuracy of source is the one when using the included binding post (99045) *1 Also compliant with JIS C 1604.

■ Common Specifications

● Source

Generation unit voltage limiter	Approx. -5 V to +36 V
Generation unit current limiter	Approx. ±30 mA
Sweep function	Step/Linear/Program
Interval time	5 to 600 s
Generation load condition	C ≤ 10 μF, L ≤ 10 mH
Output resistance	20 mΩ or less
Output response time	DC Voltage/Current/TC: Approx. 250 ms RTD/Resistance: Approx. 1 ms

● Measurement

CMRR	120 dB (50/60 Hz)
NMRR	60 dB (50/60 Hz)
Rating between terminals	H/L terminals: 50 V LOOP/mA terminals: 30 V mA/L terminals: 50 mA
Current terminal protective input	PTC protection
Maximum voltage application between measurement terminals and earth	50 V peak

■ General Specifications

Function	CA500	CA550
Display	Monochrome Dot Matrix LCD	
Built-in light	Selection of "Constantly ON", "Constantly OFF" or "Auto off by approx. 10 min" OFF, level dimming function	
Display refresh rate	Approx. 1 s	
Warm-up time	Approx. 5 min	
Language	English (default setting), Japanese, Chinese, Korean, Russian	
Power supply	DC 5 V±10%, max. 500 mA, Four alkaline AA batteries, Battery life: Approx. 16 hours (Measurement ON, 5 V output/10 kΩ or more)	
Auto power-off	Approx. 30 minutes (disabled by default)	
Ground voltage	Measurement terminal: 50 V, Source terminal: 30 V	
Insulation resistance	Between FUNCTION1-2 terminals: DC 500 V 50 MΩ or more	
Withstand voltage	Between FUNCTION1-2 terminals: 500 V AC for 10 seconds	
Dimensions	Approx. 130 (W) × 260 (H) × 53 (D) mm	
Weight	Approx. 900 g (including batteries)	
Safety standard	EN61010-1, Overvoltage Category I, Pollution Degree 2 EN61010-2-030, Measurement category O (other)	
Operation environment	Temperature: -10 to +50°C, Humidity: 80%R.H. (40°C or less), 50%R.H. (40 to 50°C) *No condensation, Altitude: 2000 m or less	
Storage environment	Temperature: -20 to +60°C, Humidity: 90%R.H. (No condensation)	
Interface	USB B communication device class	USB B communication device class, USB B mass storage class
Application	—	HART communication mode
Number of Data Records	Up to 100 results	Up to 250 CSV files
Accessories	Source lead cables, Measurement lead cables, Binding post (2 sets), USB cable (2 m, USB Type A - USB Type B), Soft case (for accessories), four AA alkaline batteries, Instruction manual (CD), Startup guide, Shoulder strap	

■ Model and Suffix code

● Accessories*1

Name	Model	Description
Lead cable for source	98020	1 red, 2 black, 1.7 m 7 mm fork terminal to alligator clip
Source/measurement lead cable	98035	3 red, 1 black, 1.7 m L plug terminal to alligator clip
Binding Post (Red Black)	99045	1 short plate attached*2
Binding Post (Red Red)	99046	1 short plate attached*2
USB Cable	A1421WL	USB Type A to Type B, 2 m
Soft Case	B8080FQ	Soft case for accessories

*1 Included with the CA500/CA550 main unit.

*2 The short plate is not used on CA500/CA550 (common parts with the CA300 series).

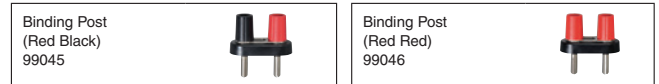
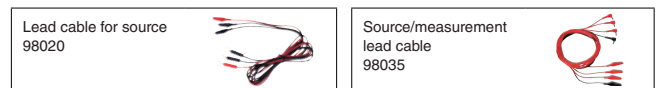

● Accessories (sold separately)

Name	Model	Description
Lead cables	98064	1 red, 1 black, 1.7 m L plug terminal to alligator clip
RJ Sensor ³⁾	90080	Pt100 JIS AA class or equivalent
Grabber Clip	98026	1 red-black pair, 2 m, separate type
Soft carrying case	SU2006A	For CA500/CA550 main unit
TC Mini Plug Set 1 ⁴⁾	90040	K (yellow)/ E (violet)/ J (black)/ T (blue)/ R+S (green)/ B+U (white)/ G (red, green)/ D (red, white)/ C (red)/ N (orange)
TC Mini Plug Set 2 ⁴⁾	90045	K (yellow)/ E (violet)/ J (black)/ T (blue)

*3: RJ sensor is dedicated to CA500/550/320, unable to be used with CA71 and CA150.

*4: Other types of mini plugs and a compensating lead wire need to be prepared by customer.



Multi Function Calibrator CA51/CA71

Simultaneous Signal Source and Measurement Capability



Features

- Source and measure operations can be performed at the same time. (Select from the following source signal and measurement signal options: voltage, current, resistance, thermocouple (TC), resistance temperature detector (RTD), frequency, pulse).
- AC voltages, including supply voltage, can be measured.
- Easy operation.
- Compact size and Lightweight
- Includes a wide array of additional functions.
 - Source
 - Values set in steps of 4-20 mA
 - 24V DC Power Supply to Transmitter
 - Divided output (n/m) function
 - Output settings are divided, eliminating the need for bothersome calculations for percentage output.
 - Autostep function
 - Changes the output value in step form based on the setting from the divided output (n/m) function. Changes can be sourced automatically every 10% or 25%.
 - Online communication (CA71 only)
 - RS-232C-compliant optically isolated interface
 - Sweep function
 - Linearly increases or decrease the output. The increasing/decreasing time can be set to either 16 or 32 seconds.
 - Memory function
 - Source values and measurements forming individual value sets can be saved to or read from the Handy Calibrator's internal memory (maximum 50 value sets).
 - Temperature monitor function

General Specifications

Parameter	Specifications
Power supply	Four AA alkaline batteries, or special AC adapter (sold separately)
Battery life	Measurement off, output 5 V DC/10 k Ω or greater: Approximately 40 hours Simultaneous signal generation/measurement, output 5 V DC/10 k Ω or greater: Approximately 20 hours Simultaneous signal generation/measurement, output 20 mA/5 V: Approximately 12 hours (using alkaline batteries, with backlight off)
Conforming standards	IEC61010-1, IEC61010-2-31 EN61326-1 EN55011, Class B, Group 1
Operating temperature and humidity ranges	0–50°C, 20–80% RH (no condensation)
External dimensions (WHD)	Approximately 190 × 120 × 55 mm
Weight	Approximately 730 g (including batteries)

Specifications

Source Unit

Parameter	Reference	Range	Accuracy (23 \pm 5°C per year)	Resolution	
DC voltage	100 mV	-10.00–110.00 mV	$\pm(0.02\% + 15 \mu\text{V})$	10 μV	
	1 V	0–1.1000 V	$\pm(0.02\% + 0.1 \text{ mV})$	0.1 mV	
	10 V	0–11.000 V	$\pm(0.02\% + 1 \text{ mV})$	1 mV	
	30 V	0–30.00 V	$\pm(0.02\% + 10 \text{ mV})$	10 mV	
DC current	20 mA	0–24.000 mA	$\pm(0.025\% + 3 \mu\text{A})$	1 μA	
	4–20 mA	4/8/12/16/20 mA		4 mA	
mA SINK	20 mA	0.1–24.000 mA	$\pm(0.05\% + 3 \mu\text{A})$	1 μA	
Resistance	400 Ω	0–400.00 Ω	$\pm(0.025\% + 0.1 \Omega)$	0.01 Ω	
RTD	Pt100	-200.0–850.0°C	$\pm(0.025\% + 0.3^\circ\text{C})$	0.1°C	
	JPt100	-200.0–500.0°C			
TC	K	-200.0–1372.0°C	$\pm(0.02\% + 0.5^\circ\text{C})$ (-100°C or greater)	0.1°C	
	E	-200.0–1000.0°C	$\pm(0.02\% + 1^\circ\text{C})$ (-100°C or less)		
	J	-200.0–1200.0°C	$\pm(0.02\% + 0.5^\circ\text{C})$ (0°C or greater)		
	T	-200.0–400.0°C	$\pm(0.02\% + 1^\circ\text{C})$ (0°C or less)		
	N	-200.0–1300.0°C	$\pm(0.02\% + 2^\circ\text{C})$ (1000°C or greater)		
	B	L	-200.0–900.0°C	$\pm(0.02\% + 1^\circ\text{C})$ (100°C or greater)	1°C
		U	-200.0–400.0°C	$\pm(0.02\% + 2^\circ\text{C})$ (1000°C or greater)	
		R	0–1768°C	$\pm(0.02\% + 2.5^\circ\text{C})$ (100°C or less)	
		S		$\pm(0.02\% + 1.5^\circ\text{C})$ (100°C or greater)	
		B	600–1800°C	$\pm(0.02\% + 1.5^\circ\text{C})$ (1000°C or greater)	
Frequency, pulse	500 Hz	1.0–500.0 Hz	$\pm 0.2 \text{ Hz}$	0.1 Hz	
	1000 Hz	90–1100 Hz	$\pm 1 \text{ Hz}$	1 Hz	
	10 kHz	0.9 kHz–11.0 kHz	$\pm 0.1 \text{ kHz}$	0.1 kHz	
	Pulse cycle	1–99,999 cycles	–	1 cycle	

Measurement Unit





- Both CA51 and CA71

Parameter	Reference	Accuracy (23 \pm 5°C per year)	Resolution
DC voltage	100 mV	$\pm(0.025\% + 20 \mu\text{V})$	10 μV
	1 V	$\pm(0.025\% + 0.2 \text{ mV})$	0.1 mV
	10 V	$\pm(0.025\% + 2 \text{ mV})$	1 mV
	100 V	$\pm(0.05\% + 20 \text{ mV})$	0.01 V
DC current	20 mA	$\pm(0.025\% + 4 \mu\text{A})$	1 μA
	100 mA	$\pm(0.04\% + 30 \mu\text{A})$	10 μA
Resistance	400 Ω	$\pm(0.05\% + 0.1 \Omega)$	0.01 Ω
AC voltage	1 V	$\pm(0.5\% + 5 \text{ dgt})$	1 mV
	10 V		0.01 V
	100 V		0.1 V
	300 V	$\pm(0.5\% + 2 \text{ dgt})$	1 V
Frequency, pulse	100 Hz	$\pm 2 \text{ dgt}$	0.01 Hz
	1000 Hz		0.1 Hz
	10 kHz	0.001 kHz	
	CPM	---	1 CPM
	CPH	---	1 CPH







- CA71 only

Parameter	Reference	Accuracy (23 \pm 5°C per year)	Resolution
TC	K	$\pm(0.05\% + 1.5^\circ\text{C})(-100^\circ\text{C or greater})$	0.1°C
	E		
	J		
	T	$\pm(0.05\% + 2^\circ\text{C})(-100^\circ\text{C or less})$	1°C
	N		
	L		
B	U	$\pm(0.05\% + 3^\circ\text{C})(100^\circ\text{C or less})$	1°C
	R		
	S		
RTD	Pt100	$\pm(0.05\% + 0.6^\circ\text{C})$	0.1°C
	JPt100		

Spare parts

Product	Source signal lead cable	Measurement lead cable	Carrying case	Terminal adapter
				
Model	98020	RD031	93016	99021

Optional accessories (sold separately)

Product	AC adapter			RJ sensor	Accessory storage case	Communication cable (RS232)
						
Model	94013	94016-F	94016-S	B9108WA	B9108XA	91017
Remarks	120 V AC	220 to 240 V AC VDE standard	220 to 240 V AC BS standard	For reference junction compensation	Lead cables, RJ sensor, etc. can be stored	D-sub 9-pin (female)

Process Calibrator CA300 Series

High-performance Model Specialized for Loop Inspection



CA310

Volt mA calibrator

- Basic accuracy: 0.015% (source and measurement accuracy of voltage mA)
- 20 mA SIMULATE (SINK) function
- Simultaneously measures 24 V loop power and output signals with high accuracy
- Built-in HART/BRAIN communication resistance (250 Ω)
- Sub-display indicates span% of the source value.
- Handles various source patterns
(Step sweep/linear sweep/manual step/span check)

Specifications

Source	V DC : 500 mV/5 V/30 V mA DC : 20 mA/20 mA SIMULATE
Measurement	V DC : 500 mV/5 V/30 V/50 V mA DC : 20 mA/50 mA 24-V loop power source: 24 V±1 V (communication resistance: off) 24 V±6 V (communication resistance: on)
General specifications	<ul style="list-style-type: none"> • Dimensions : 90 (W) × 192 (H) × 42 (D) mm • Weight : Approx. 440 g • Power source : AA battery (LR6) × 4 or dedicated AC adapter (option) • Sweep function : Step (25%)/linear • Sweep time : 15 sec/30 sec/45 sec/60 sec

Bulletin: CA300-EN

High-performance Model Specialized for Simulating Thermocouples



CA320

TC calibrator

- Basic accuracy: 0.5°C (typical of Type K)
* Including the accuracy of an internal RJC
- Accepts 16 types of thermocouple (JIS/IEC/DIN/ASTM/GOST R)
- Sub-display indicates the voltage source value and span%.
- Simulates other types of thermocouple with the mV source function
- Works as a thermometer to measure the output from the TC sensor
- Handles various source patterns
(Step sweep/linear sweep/manual step/span check)

Specifications

Source	Thermocouple: K, E, J, T, N, L, U, R, S, B, C, XK, A, D, G, PLATINEL2 mV DC : 90 mV
Measurement	Thermocouple: K, E, J, T, N, L, U, R, S, B, C, XK, A, D, G, PLATINEL2 mV DC : 90 mV
General specifications	<ul style="list-style-type: none"> • Dimensions : 90 (W) × 192 (H) × 42 (D) mm • Weight : Approx. 440 g • Power source : AA battery (LR6) × 4 or dedicated AC adapter (option)

Bulletin: CA300-EN

High-performance Model Specialized for Simulating RTDs



CA330

RTD calibrator

- Basic accuracy: 0.3°C (typical of Pt100)
- Accepts 14 types of RTD (JIS/IEC/GOST R)
- Sub-display indicates the resistance source value and span%.
- Accepts 2-, 3-, 4-wire systems and simulates RTDs precisely
- Simulates other types of RTD with the resistance source function
- Works as a thermometer to measure the output from the RTD sensor
- Handles various source patterns
(Step sweep/linear sweep/manual step/span check)

Specifications

Source	RTD : Pt100 (four types), Pt200, Pt500, Pt1000, Cu10, Ni120, Extra RTD (five types) Resistance : 500 Ω/3000 Ω
Measurement	RTD : Pt100 (four types), Pt200, Pt500, Pt1000, Cu10, Ni120, Extra RTD (five types) Resistance : 500 Ω/3000 Ω
General specifications	<ul style="list-style-type: none"> • Dimensions : 90 (W) × 192 (H) × 42 (D) mm • Weight : Approx. 440 g • Power source : AA battery (LR6) × 4 or dedicated AC adapter (option)

Bulletin: CA300-EN

Process Multi Meter **CA450**













Loop Power and 4 to 20 mA Output function in a DMM



Features

- Loop check functions
 - Simultaneous 24 V loop power and mA measurement
 - HART/BRAIN mode setting with loop power (Adds 250 ohm resistance internally)
 - Generation functions
 - SIMULATE (SINK) function simulates transmitters
 - 4-20 mA span/step/auto-step/sweep output
 - Measurement functions
 - High accuracy signal measurement: DC mA 0.05%/30.000 mA
 - Handheld DMM function
 - Peak Hold function for the peak voltage measurement of DCS power supply
 - Dedicated sensor modes for direct reading of many sensor signal types
 - Enhanced Safety—helps eliminate electric shocks
 - Current terminal shutter prevents incorrect connections
 - 1 A or more of AC/DC current can be read directly using the optional clamp probe and scaling in SENSOR mode.*1
 - Measurement categories 600 V CAT. IV, 1000 V CAT. III
- *1: AC/DC 600 mV range only

Accessories

 <p>Test leads Model:98073</p>	 <p>Lead Cables Model:98064</p>	 <p>Fuse Model:99042</p>	 <p>DMM Communication Package 92015 (*1)</p>
 <p>Alligator Test leads Model:99014</p>	 <p>AC/DC Clamp-on Probe Model:96095</p>	 <p>Current Clamp-on Probe Model:96001</p>	 <p>Carrying Case Model:93029</p>
 <p>Magnet hook Model:99032</p>  <p>The Magnet hook can be attached to magnetic body (e.g. iron).</p>	 <p>Carrying Case Model:93043-P1</p>		 <p>The inner case with detachable straps can be hung on bar.</p>

(*1) Settings for output is not capable.

Specifications

Measurement

Function	Range	Resolution	Max Accuracy
DCV	600 mV/6 V/60 V/600 V/1000 V	0.1 mV/0.001 V/0.01 V/0.1 V/1 V	0.09%+2 digits
ACV		0.1 mV/0.001 V/0.01 V/0.1 V/1 V	0.5%+5 digits
DCA	30 mA/60 mA	0.001 mA/0.01 mA	0.05%+2 digits
Resistance	600 Ω/6 kΩ/60 kΩ/600 kΩ/6 MΩ /60 MΩ	0.1 Ω/0.001 kΩ/0.01 kΩ/0.1 kΩ /0.001 MΩ/0.01 MΩ	0.2%+2 digits
Freq	10Hz to 199.99 Hz	0.01 Hz	0.005%+1 digits
	90Hz to 1999.9 Hz	0.1 Hz	
	0.900 kHz to 19.999 kHz	0.001 kHz	
Source			
DCmA	20 mA	0.001 mA	0.05% of range
Loop Power	24 V		24 VDC (typ.) Load current 20 mA

Other Functions and Specion
Functions Diode check, Continuity check, Data Hold, Peak Hold, Step mode, linear mode, Sensor mode, MIN/MAX, REL*%

General Specifications

Specifacaton

- Display : 5-digit (7 Segment)
 - Measurement DC current 33000, Frequency 19999, Other 6600
 - Output DC current 25000
- Operating temperature and humidity: -20 to 55°C (80%RH or less) with no condensation
- Storage temperature and humidity: -40 to 70 (70%RH or less) with no condensation
- Battery life: DC voltage measurement: Approx.140 hours
DC current output (SIMULATE) Approx.140 hours
DC current output (SOURCE) 12 mA (500 Ω load) Approx.10 hours
- External dimensions: Approx. 90 (W) × 192 (H) × 49 (D) mm
- Weight: Approx. 600 g (including the batteries)
- Compliant standards:
 - Safety standards: EN61010-1, EN61010-2-030, EN61010-2-033, EN61010-031
 - Measurement Categories:
 - 1000 V CATIII, 600 V CATIV
 - For current measurement and output: 48 V max, 100 mA max
 - Lead cables (98064): 70 VDC, 100 mA
 - Pollution degree 2, indoor use
 - Vibration:
 - Sweep vibration frequencies 10 Hz to 5 Hz to 10 Hz
 - Amplitude 0.15 mm (peak value)
 - Duration 30 minutes
 - Shock:
 - 1 m drop test as defined by the safety standards
- Altitude: 2000 m or less
- EMC standards: EN61326-1 Class B, EN61326-2-2 EN55011 Class B Group 1
- Influence of radiated immunity: In RF electromagnetic fields of 3 V/m
- EN61326-1 AC voltage measurement, 600 mV range:1.5% of range
- DC voltage measurement, 600 mV range:1% of range
- DC current measurement, all ranges: 1.5% of range
- DC current output: 1.5% of range
- EN61326-2-2 AC voltage measurement (6 V range or higher): Within 5 times the accuracy
- DC voltage measurement (6 V range or higher): Within 5 times the accuracy

Power Quality Analyzer **CW500**

High-end Model for Measuring Power Consumption and Power Quality



Bulletin: CW500-EN



Features

- Achieves various power measurements with simple operations
 - One press on direct keys switches to any of five measurement displays.
- Identifies power source malfunctions
 - Sampling with a 24- μ s resolution can identify temporary malfunctions.
 - Measures harmonics and flickers
- User support
 - Easy wiring and setting with the start navigation function and automatic detection of clamp-on probes
- PC software for analysis and setting comes as standard.
 - Data can be compiled into graphs and reports with one click.

Specifications

Wiring connection:	1P2W (max. 4 systems), 1P3W (max. 2 systems), 3P3W 2 currents (max. 2 systems), 3P3W 3 currents, 3P4W
Input:	3 channels for voltage, 4 channels for current, 2 channels for DC voltage
Range:	AC voltage 600.0/1000 V AC current 2000 mA to 3000 A (depending on a clamp-on probe) AC power 3000 W to 3000 kW (depending on a clamp-on probe) DC voltage 100.0 mV/1.000 V/10.00 V
Accuracy:	Voltage $\pm 0.2\% \text{rdg} \pm 0.2\% \text{mg}$ Current $\pm 0.2\% \text{rdg} \pm 0.2\% \text{mg} + \text{accuracy of clamp-on probes}$ Power $\pm 0.3\% \text{rdg} \pm 0.2\% \text{mg} + \text{accuracy of clamp-on probes}$ Effect of power factor $\pm 1.0\% \text{rdg}$ (reading at power factor 0.5 against 1.0)
Measurement items:	<ul style="list-style-type: none"> • Voltage, current, frequency, power factor, effective/reactive/apparent power • Consumption/generation of effective/apparent power, delay/progress of reactive power • Demand, maximum demand, load factor, estimated demand value • Temporary malfunction: voltage swell, voltage dip, voltage interrupt, transient overvoltage, inrush current • Continuous malfunction: components of up to the 50th harmonic (RMS, content rate, and phase angle of voltage, current, and power), total harmonic distortion rate, IEC flicker, voltage unbalance rate, current unbalance rate
Measurement display:	measurement values, trend graphs for all or each channel from the start of measurement, measured demand values, demand trend over a specific period or a whole period
Record interval:	1/2/5/10/15/20/30 sec, 1/2/5/15/20/30 min, 1 h/2 h
General specification:	Dimensions: 120 (W) \times 175 (H) \times 68 (D) mm Weight: Approx. 900 g (including batteries) Power source: 100 to 240 V AC /50 to 60 Hz/alkaline AA battery \times 6/power supply adaptor (option)
Accessories:	Voltage probe, USB cable, power cord, carrying bag, SD card, startup guide, alkaline AA battery \times 6, input terminal plate \times 6, PC software

Clamp-on probes for the CW500 Power Quality Analyzer

Model code	96060	96061	96062	96063	96064	96065	96066
Clamp-on probe							
Measurable diameter	$\phi 40$ mm	$\phi 18$ mm	$\phi 24$ mm	$\phi 30$ mm	$\phi 40$ mm	$\phi 110$ mm	$\phi 150$ mm
Measuring range	2 A AC	50 A AC	100 A AC	200 A AC	500 A AC	1000 A AC	300 A AC 1000 A AC 3000 A AC
Output voltage	50 mV AC (25 mV/A)	500 mV AC (10 mV/A)	500 mV AC	500 mV AC	500 mV AC	500 mV AC	500 mV AC For each range
Accuracy	50 Hz/ 60 Hz	$\pm 0.5\% \text{rdg}$ $\pm 0.1 \text{ mV}$	$\pm 0.5\% \text{rdg}$ $\pm 0.1 \text{ mV}$	$\pm 0.5\% \text{rdg}$ $\pm 0.1 \text{ mV}$	$\pm 0.5\% \text{rdg}$ $\pm 0.1 \text{ mV}$	$\pm 0.8\% \text{rdg}$ $\pm 0.2 \text{ mV}$	$\pm 1.0\% \text{rdg}^*$
	40 Hz to 1 kHz	$\pm 2.0\% \text{rdg}$ $\pm 0.1 \text{ mV}$	$\pm 0.8\% \text{rdg}$ $\pm 0.2 \text{ mV}$	$\pm 1.0\% \text{rdg}$ $\pm 0.2 \text{ mV}$	$\pm 0.8\% \text{rdg}$ $\pm 0.2 \text{ mV}$	$\pm 1.5\% \text{rdg}$ $\pm 0.4 \text{ mV}$	—
	1 kHz to 3.5 kHz	$\pm 3.0\% \text{rdg}$ $\pm 0.2 \text{ mV}$	$\pm 1.0\% \text{rdg}$ $\pm 0.4 \text{ mV}$	—	$\pm 1.0\% \text{rdg}$ $\pm 0.4 \text{ mV}$	—	—
Accuracy Degree	—	Less than $\pm 2.0^\circ$ (0.5 to 50 A, 40 Hz to 3.5 kHz)	Less than $\pm 2.0^\circ$ (1 to 100 A, 45 Hz to 65 Hz)	Less than $\pm 1.0^\circ$ (2 to 200 A, 40 Hz to 3.5 kHz)	Less than $\pm 1.0^\circ$ (5 to 500 A, 45 Hz to 65 Hz)	Less than $\pm 2.0^\circ$ (45 Hz to 65 Hz) Less than $\pm 3.0^\circ$ (40 Hz to 1 kHz)	Less than $\pm 1.0^\circ$ (for each range/ 45 to 65 Hz)
Max Circuit voltage	AC 300 Vrms	AC 300 Vrms	AC 300 Vrms	AC 600 Vrms	AC 600 Vrms	AC 600 Vrms	AC 600 Vrms
Dimensions	70 \times 120 \times 25 mm	52 \times 106 \times 25 mm	60 \times 100 \times 26 mm	73 \times 130 \times 30 mm	81 \times 128 \times 36 mm	73 \times 130 \times 30 mm	61 \times 111 \times 43 mm
Weight	Approx. 250 g	Approx. 170 g	Approx. 160 g	Approx. 250 g	Approx. 260 g	Approx. 170 g	Approx. 950 g
Remarks	These probes are dedicated for the CW500 and cannot be used for the CW240/CW120/CW121.						

*1 45 to 65 Hz (measuring at the center of sensor)

*2 Clamp-on probe 96060 can not be used for power measurement

A Powerful Power Measuring Tool **CW10**



Features

- AC / DC Power up to 600 kW
- True RMS for AC.
- Harmonics 1st to 25th order
- Power fluctuation using the ACA Inrush and Peak hold functions.
- AC / DC Voltage max. 1000 V
- AC / DC Current max. 600 A
- Frequency, Resistance, Continuity, Diode check, Power factor.
- Up to 9999 counts, approx. 37 mm max. diameter of measurable conductor (the jaw opens approx. 45 mm max.)

Specifications

Accuracy

23± 5°C, 80%RH or less
Accuracy: ±(% of reading + digits)

Voltage

Function	Range	Resolution (Maximum reading)	Accuracy*
DCV	100 V	99.99 V	0.7% + 2
	1000 V	999.9 V	
ACV	100 V	99.99 V	1.0% + 5 50 to 500 Hz
	1000 V	999.9 V	
LPF ACV	100 V	99.99 V	50 ≤ f ≤ 60 Hz: 1.0% + 5 60 < f ≤ 400 Hz: 5.0% + 5
	1000 V	999.9 V	

* DCV<1000 digits: add 6 digits to accuracy
ACV<1000 digits: add 3 digits to accuracy
Maximum input voltage: 1000 Vrms, 1414.2 Vpk
Input impedance: approx. 3.5 MΩ, <100 pF
AC+DC Vrms accuracy=ACV accuracy + DCV accuracy

Crest factor effects
1.4 < CF ≤ 2.0: add 1.0% of reading to accuracy
2.0 < CF ≤ 2.5: add 2.5% of reading to accuracy
2.5 < CF ≤ 3.0: add 4.0% of reading to accuracy
Maximum input voltage: 690 Vrms CF=2 460 Vrms CF=3

Current

Function	Range	Resolution (Maximum reading)	Accuracy*
DCA	100 A	99.99 A	1.5% + 20
	600 A	600.0 A***	
ACA	100 A**	99.99 A	50 ≤ f ≤ 60 Hz : 1.5% + 5* 60 < f ≤ 400 Hz : 2.0% + 5*
	600 A	600.0 A***	
LPF ACA	100 A**	99.99 A	50 ≤ f ≤ 60 Hz : 1.5% + 5 60 < f ≤ 400 Hz: 5.0% + 5
	600 A	600.0 A***	

*The measured value <1000 digits: add 5 digits to accuracy
**Input current ≥ 0.10 A at 100 A range of ACA and LPF ACA
***600 A : Guaranteed accuracy (not maximum reading)
Maximum input current: 600 Arms, 848.5 Apk
Conductor position effects: ±1.0% of reading
AC+DC Arms accuracy=ACA accuracy + DCA accuracy

Crest factor effects
1.4 < CF ≤ 2.0: add 1.0% of reading to accuracy
2.0 < CF ≤ 2.5: add 2.5% of reading to accuracy
2.5 < CF ≤ 3.0: add 4.0% of reading to accuracy
Maximum input current: 420 Arms CF=2 280 Arms CF=3

Peak Hold (AC mode only)

Function	Range	Resolution (Maximum reading)	Accuracy
ACV	100 V	140.0 V	3.0% + 15
	1000 V	1400 V	
ACA	100 A	140.0 A	3.0% + 15
	600 A	850 A	

PEAK MAX: polarity+, polarity-
Maximum input voltage and current: 1000 Vrms, 600 Arms
Sine wave, ACV ≥ 5 Vrms, ACA ≥ 5 Arms, 50 to 400 Hz continuous wave

Frequency (Hz)

Function	Resolution (Measuring range)	Accuracy
100 Hz	20.00 to 99.99 Hz	0.5% + 3
1000 Hz	20.0 to 999.9 Hz	
10 kHz	0.020 to 9.999 kHz	

Maximum input voltage and current: 1000 Vrms, 600 Arms
Input condition: 100 V range: 10 to 100 Vrms
(Sine wave) 1000 V range: 100 to 1000 Vrms
100 A range: 10 to 100 Arms (<400 Hz)
600 A range: 100 to 600 Arms (<400 Hz)
The measured value < approx. 10 Hz: 0.00 Hz

Harmonic Measurement

Individual Harmonic

Harmonic order	Resolution (Maximum reading)	Accuracy
1st to 12th (h01- h12)	99.9%	5% + 10
13th to 25th (h13- h25)		10% + 10

Maximum input voltage and current: approx. 1000 Vrms, 600 Arms
The "rdy" is displayed at ACV < 10 Vrms, ACA < 10 Arms
The "OutF" is displayed at f < 45, 65 < f (f: fundamental frequency)

Inrush Current

Function	Range	Resolution (Maximum reading)	Accuracy
ACA	100 A	99.99 A	2.5% + 20
	600 A	600.0 A*	

Maximum input current: approx. 600 Arms
*600 A : Guaranteed accuracy (not maximum reading)
100 A range: ACA1 ≥ 10 Arms (Sine wave, 50 Hz/60 Hz)

600 A range: ACA ≥ 100 Arms (Sine wave, 50 Hz/60 Hz)
Measurement time: approx. 100ms

Active Power

Function	Range	Resolution (Maximum reading)	Accuracy
ACW DCW	10 kW	9.999 kW*	ACW: 2.5% + 11** DCW: 2.2% + 22**
	100 kW	99.99 kW	
	600 kW	600.0 kW**	

* The measured value < 1.000 kW: add 10 digits to the accuracy.
**Conditions of accuracy (combination of Voltage and Current range)
10 kW range: 100 V and 100 A
100 kW range: 100 V and 600 A or 1000 V and 100 A
600 kW range: 1000 V and 600 A
Other combinations:
Accuracy: (Current accuracy/Voltage reading) + (Voltage accuracy/Current reading)

**600 kW : Guaranteed accuracy (not maximum reading)
Maximum input voltage and current: 1000 Vrms, 600 Arms
ACW: ACV ≥ 10 Vrms and ACA ≥ 5 Arms (Sine wave, 50 ≤ f ≤ 60 Hz, PF=1.00)
DCW: at DCV ≥ 10 V and DCA ≥ 5 A

Power Factor

Function	Resolution (Measuring range)	Accuracy
Power factor	-1.00 to 0.00 to 1.00	±(3*+2digits)

Maximum input voltage and current: 1000 Vrms, 600 Arms
PF: ACV ≥ 10 Vrms and ACA ≥ 5 Arms (Sine wave, 50 ≤ f ≤ 60 Hz)

Resistance/Continuity check

Function	Range	Resolution (Maximum reading)	Accuracy
Resistance Ω	1000 Ω	999.9 Ω	1.0% + 5
	10 kΩ	9.999 kΩ	
	100 kΩ	99.99 kΩ	
Continuity check	1000 Ω	999.9 Ω	1.0% + 5
	The buzzer turns on for resistances lower than approx. 30 Ω. (Response time: approx. 100 msec)		

Maximum input voltage: 1000 Vrms
Maximum test current: approx. 0.5 mA
Open circuit voltage: approx. 3 V

Diode Test

Function	Resolution (Measuring range)	Accuracy
Diode Test	0.40 to 0.80 V	±0.1 V

Maximum test current: approx. 0.5 mA
Open circuit voltage: approx. 1.8 V

General Specifications

Display count: 9999 / 6000
Measuring rate: 3 times / sec.
Over range indicator: "OL" or "-OL"
Auto Power Off: Approx. 15 minute.
Low-battery indicator: █ (four steps)
Power supply: 9 V alkaline battery (6LR61)
Battery life: When using alkaline battery, backlight off
Approx. 20 hours

Operating temperature and humidity: 0 to 50°C (with no condensation)
≤ 80% RH (0 to 30°C)
≤ 75% RH (30 to 40°C)
≤ 45% RH (40 to 50°C)

Temperature coefficient: At 0 to 18 °C and 28 to 50°C
Add 23±5 °C accuracy x 0.2 / °C

Storage temperature: -10 to 50 °C, 80% RH or less (remove the battery)

Withstand voltage: AC 6880 Vrms 5 sec. (between the core and the case)
AC 4300 Vrms 5 sec. (between the core and the voltage input terminals)
AC 6880 Vrms 5 sec. (between the voltage input terminals and the case)

Insulation resistance: 100 MΩ or greater at 1000 VDC
(between the core and the case, the core and the voltage input terminals and the voltage input terminals and the case)

Compliant standards:
Safety standards: EN 61010-1, EN 61010-2-032
1000V CAT.III, 600V CAT.IV
EN 61010-031 (the test leads)
Pollution degree 2, Indoor use, Altitude 2000m or less
EMC standards: EN 61326-1, EN 61326-2-1, EN 61326-2-2, EN 55011

Dimensions: Approx 87.5 mm(W) × 242 mm(L) × 51 mm(D)
Diameter of measurable conductors: φ 37mm (Maximum)
Weight: Approx. 435 g (including the battery)
Accessories: Test leads 1 set (Red and Black)
Carrying case
9 V alkaline battery (6LR61)
User's Manual

Accessories (Sold Separately): Lead with Alligator Clip Model code 99014

Clamp-on Power Meters

Handheld Digital Multi Meter Selection

Function item	Handheld Digital Multi Meter Models			
	TY710	TY720	TY520	TY530
Measurement Function	RMS	RMS MEAN (Switching)	RMS	RMS MEAN (Switching)
Max. Measurement Accuracy at DCV	0.02%		0.09%	
Wide bandwidth	20 KHz	100 KHz	1 kHz	
Display Digits(Uint:Digit)	5 digits		3.5 Digits	
Max. Value	50000		6000	
Bar Graph Display (Uints:Segment)	51		31	
LCD Back Light	White LED		LED	
Max.Measurement Voltage (AC/or DC)	50.000 mV to 1000.0 V	50.000 mV to 1000.0 V	600.0 mV to 1000 V	600.0 mV to 1000 V
Max.Measurement Currents (AC/or DC)	500.00 µA to 10.000 A	500.00 µA to 10.000 A	600.0 µA to 10.00 A	600.0 µA to 10.00 A
Max.Measurement Resistance	500.00 Ω to 50.000 MΩ	500.00 Ω to 50.000 MΩ	600.0 Ω to 60.00 MΩ	600.0 Ω to 60.00 MΩ
Max.Measurement Frequency	2.000 Hz to 99.99 kHz	2.000 Hz to 99.99 kHz	10.00 Hz to 99.99 kHz	10.00 Hz to 99.99 kHz
Max.Measurement Capacitance	5.000 nF to 50.00 mF	5.000 nF to 50.00 mF	10.00 nF to 1000 µF	10.00 nF to 1000 µF
Max.Measurement Temperature	+1372°C ¹	+1372°C ¹	+600°C ¹	+600°C ¹
Duty Ratio (%) Measurement	●	●	—	—
Low-Power	—	●	—	—
AC+DC Measurement	●	●	—	—
Max./Min./Ave. Value Memory	●	●	—	●
Diode Test	●	●	●	●
Continuity Check	●	●	●	●
Relative/Percentage (%) calculation	●	●	●	●
Decibel calculation	●	●	—	—
Selection Auto range or Manual range	●	●	●	●
Peak Hold	—	●	—	—
Data Hold	●	●	●	●
Auto Hold	●	●	●	●
Communication for PC	● ²	● ²	—	● ²
Data Logging Memory	● ²	● ²	—	● ²
Data Memory	1000	10000	—	1600
Operating Temp. and Humidity	-20 to 55°C	-20 to 55°C	-10 to 55°C	-10 to 55°C
Electric Safety 1000 V	CAT III		CAT III	
Electric Safety 600 V	CAT IV		CAT IV	
Electric Safety 300 V	—		—	

¹ Temperature probe is necessary when measuring temperature.
² The communications package (model: 92015) for DMM is necessary when connecting it with PC.

Simple selection for replacing discontinued products

Existing model	Discontinued products for replacing	4.5 Digits										3.5 Digits				
		73402	73401	754402	754401	73301	73302	73303	753801	753704	753703	753702	753701	7534series	7533series	
TY720	●	●														
TY710		●	●													
TY530						●		●								
TY520					●	●		●		●	●	●	●	●	●	●

Handheld Digital Multi Meter **TY700 Series****A New De Facto Standard for Handheld DMM****Features**

- 50000 counts
- Measures true RMS value
- High accuracy: 0.02% rdg (DCV range)
- DCV + ACV measurement
- Supports EN61010-1 1000V III and 600V CAT IV
- Operates in a wide range of temperatures from -20 to 55°C
- Provides strong support for data management:
 - equipped data memory for logging
 - connection with a PC via USB communication
- Data storage capacity: 1000 data (TY710), 10000 data (TY720)
- Current terminal shutter for preventing incorrect connections
- Various measurement functions
 - Peak hold function (TY720 DCV/DCA range)
 - Decibel calculation function
 - Maximum, minimum and average value display
 - Dual display

Specifications

Model		TY720			TY710		
Detection method		RMS/MEAN (switching)			RMS		
Item	Range	Accuracy					
DC voltage	50 mV	0.05 + 10					
	500 mV /2400 mV	0.02 + 2					
	5 V	0.025 + 5					
	50 V/500 V/1000 V	0.03 + 2					
AC voltage (RMS)	50 mV	10 to 20 Hz	1 kHz to 10 kHz	20 kHz to 50 kHz	10 to 20 Hz	1 kHz to 10 kHz	20 kHz to 50 kHz
		20 Hz to 1 kHz	10 kHz to 20 kHz	50 kHz to 100 kHz	20 Hz to 1 kHz	10 kHz to 20 kHz	50 kHz to 100 kHz
	500 mV/5 V/ 50 V/500 V	2 + 80	5 + 40	15 + 40	—	—	—
		0.4 + 40	5.5 + 40	15 + 40	—	—	—
1000 V	1 + 30	0.4 + 30	2 + 70	1.5 + 30	0.7 + 30	—	
	0.4 + 30	1 + 40	5 + 200	0.7 + 30	2 + 50	—	
AC voltage (MEAN)	50 mV	10 to 20 Hz	20 Hz to 500 Hz	500 Hz to 1 kHz	—		
	500 mV/5 V/ 50 V/500 V/1000 V	4 + 80	1.5 + 30	5 + 30	—		
	2 + 30	1 + 30	3 + 30	—			
DCV + ACV	5 V/50 V/500 V	DC, 10 to 20 Hz	DC, 1 kHz to 10 kHz	DC, 20 kHz to 50 kHz	DC, 10 to 20 Hz	DC, 1 kHz to 10 kHz	DC, 20 kHz to 50 kHz
		20 Hz to 1 kHz	10 kHz to 20 kHz	50 kHz to 100 kHz	20 Hz to 1 kHz	10 kHz to 20 kHz	50 kHz to 100 kHz
	1000 V	1.5 + 10	0.5 + 10	2 + 10	1.5 + 10	1 + 10	—
DC current	500 μA/5000 μA/ 50 mA/500 mA	0.2 + 5					
	5 A	0.6 + 10					
	10 A	0.6 + 5					
AC current (RMS)	500 μA/5000 μA/ 50 mA/500 mA	10 Hz to 20 Hz	20 Hz to 1 kHz	1 kHz to 5 kHz	10 Hz to 20 Hz	20 Hz to 1 kHz	1 kHz to 5 kHz
	5 A/10 A	1 + 20	0.75 + 20	1 + 30	1.5 + 20	1 + 20	—
AC current (MEAN)	500 μA/5000 μA/ 50 mA/500 mA	10 Hz to 20 Hz	20 Hz to 1 kHz	1 kHz to 5 kHz	—		
	5 A/10 A	2 + 20	1.5 + 20	2 + 30	—		
DCA + ACA	500 μA/5000 μA/ 50 mA/500 mA	DC, 10 to 20 Hz	DC, 20 Hz to 1 kHz	DC, 1 kHz to 5 kHz	DC, 10 to 20 Hz	DC, 20 Hz to 1 kHz	DC, 1 kHz to 5 kHz
	5 A/10 A	1.5 + 10	1 + 10	1.5 + 10	2 + 10	1.5 + 10	—
Resistance	500 Ω/5 kΩ/50 kΩ	0.05 + 2			0.1 + 2		
	5 MΩ	0.5 + 2					
Low power resistance	5 kΩ/50 kΩ/500 kΩ	1 + 2					
	5 MΩ	—					
Frequency	2.0 to 99.99 kHz	0.02 + 1					
Capacitance	5 nF/50 nF/500 nF	1 + 5					
	5 μF/50 μF	2 + 5					
	500 μF	3 + 5					
Continuity check	500 Ω	Buzzer is turned on when 100±50 Ω or less					
Diode test	2.4 V	1 + 2					
Temperature	-200 to 1372°C	1 + 1.5°C					
Other measurements	Duty cycle/decibel calculation/max. min. and avg. value calculation/deviation percentage (%) calculation						
Additional functions	Data hold/auto hold/peak hold (only TY720)/range hold/manual memory logging memory/auto power off/back light (white LED)						
Applicable standards	Safety standard: EN61010-1, EN61010-031 1000V CAT III, 600 V CAT IV pollution level 2 EMC standard: EN61326-1 ClassB EN55022 ClassB Group 1						
Display	LCD (digital display: 50,000 counts, dual/bar graph display: 51 segments)						
Measurement cycle	6 times/second (digital display), 15 times/second (bar graph display)						
Power source and battery life	4 alkaline AA batteries/approx. 120 hours (continuous use)						
External dimensions and weight	Approx. 90 (W) × 192 (H) × 49 (D) mm/approx. 560 g (including batteries)						
Standard Accessories	Instruction manual/4 alkaline AA batteries/a set of test lead/fuse (main frame storage) 440 mA/1000 V and 10 A/1000 V						
Optional Accessories (sold separately)	DMM communication package (92015) TC-K temperature probe (90050B, 90051B, 90055B, 90056B), Carrying case (93029)						

Handheld Digital Multi Meter **TY500 Series**

Provides Safety Levels Demanded in Field Work



Features

- 6000 counts
- High accuracy: 0.09% rdg (DCV range)
- Supports EN61010-1 1000 V CAT III and 600 V CAT IV
- Can measure AC/DC current with the AC/DC clamp-on probe (sold separately) in the sensor mode
- Includes data memory for logging (up to 1600 data) (only TY530)
- Current terminal shutter for preventing incorrect connections
- Various measurement functions
 - Filter on/off function
 - Maximum, minimum and average value display (only TY530)

Specifications

*Accuracy: ±(% of reading + minimum number of digits)

Model		TY530	TY520
Detection method		RMS/MEAN (switching)	RMS
Item	Range	Accuracy	
DC voltage	600 mV/6 V/60 V/600 V	0.09 + 2	
	1000 V	0.15 + 2	
AC voltage	600 mV/6 V/60 V/600 V	500 to 1 kHz	40 to 500 Hz
		1.5 + 5	50/60 Hz
	1000 V	—	1 + 5
DC current	600 µA/6000 µA/60 mA	0.2 + 2	
	600 mA/6 A/10 A	0.5 + 5	
AC current	600 µA/6000 µA/60 mA/600 mA/6 A/10 A	40 to 1 kHz	50/60 Hz
		1.5 + 5	0.75 + 5
	600 Ω/6 kΩ/60 kΩ/600 kΩ	0.4 + 1	
Resistance	6 MΩ	0.5 + 1	
	60 MΩ	Less than 0-40 MΩ	
Frequency	10 to 99.99 kHz	0.02 + 1	
	1 nF	2 + 10	
Capacitance	100 nF/1 µF/10 µF	2 + 5	
	100 µF/1000 µF	3 + 5	
Continuity check	600 Ω	Buzzer is turned on when 50±30 Ω or less	
Diode test	2 V	1 + 2	
Temperature	-50 to 600:	2 + 2°C	
Other measurements	On/off switching of low path filter, RMS/MEAN value switching (only TY530)		
Additional functions	Data hold/auto hold/range hold/deviation percentage (%) calculation/auto power off/back light/sensor function (scaling function)		
	Functions included only in TY530: maximum, minimum and average value display, communication function, memory function, logging memory (up to 1600 data)		
Applicable standards	Safety standard: EN61010-1, EN61010-031, 1000 V CAT III, 600 V CAT IV pollution level 2		
	EMC standard: EN61326-1 ClassB, EN55022 ClassB Group 1		
Display	3.5-digit LCD (digital display: 6,000 counts, dual/bar graph display: 31 segments)		
Measurement cycle	5 times/second (digital display), 25 times/second (bar graph display)		
Power source and battery life	4 alkaline AA batteries/approx. 300 hours (when direct voltage is measured and alkaline AA batteries are used.)		
External dimensions and weight	Approx. 90 (W) × 192 (H) × 49 (D) mm/approx. 570 g (including batteries)		
Accessories	Instruction manual/4 alkaline AA batteries/a set of test lead		

DMM of dedicated application software **92015**

DMM's and you can easily manage the data in memory.
Is also capable of real-time communications



Features

- Data saved in the internal memory PC transfer is possible (Save memories or Logging Memories)
- DMM measurements show in real time monitor display is possible.
- Large amounts of data not covered by the internal memory PC communication with data transfer is possible. At the same time Excel transferable is also.
- Measurement data to Excel direct deployment is possible. Automatically creates a chart sheet.

92015 product specification:

Communication cable

Communications cable: infrared communication adapter + communications cable (USB specifications) 2 m length

Interface standards: USB specification conforms to the 1.1

Available models : TY710, TY720, TY530, CA450

Application software

Operating environment of the personal computer

OS: Windows 7 / 8 / 10

Excel: since the Excel2016

Software: CD, communication cable (including adapter), User's manual

DMM Accessories



96095

AD/DC Clamp-on Probe

- Light and compact, easy to carry and easy to clamp on crowded wirings.
- Expands measuring span of currents and assure safety when measuring with any kind of DMM.

Specifications

Model	96095		
Conductor Size	φ 12mm		
Measurement range	Output voltage	Accuracy (at 23°C±5°C)	
AC 0.1 to 130 A	AC10 mV/A(AC 1 to 1300 mVrms)	50/60 Hz	40 Hz to 1 kHz
DC 0 to ±180 A	DC10 mV/A (DC 0 to ±1800 mV)	1.2% + 0.4 mV	2.5% + 0.4 mV
General specifications			
Operating Temp&Humidity range	-10 to 55°C relative Humidity 85% or less (no condensation)		
Storage Temp&Humidity range	-30 to 70°C relative Humidity 85% or less (no condensation)		
Power source	DC3 V(Size AAA alkaline Battery LR03 × 2 pcs) Low battery warning: 2.2 V±0.2 V or less red LED flash 1.9 V±0.2 V or less Power off		
Continuous use	Approx. 35 Hours till a low battery indicator flashes ¹		
Dimensions&Weight	127 (L) × 42 (W) × 22 (D) mm Cord length: Approx. 1200 mm Weight: Approx 140 g		
Applicable standards	EN61010-1: CAT III Pollution degree2, Altitude 2000 m or less for indoor use EN61326-1: ClassB,EN61326-2-032		
Accessories	Soft case(94030),Battery,User's Manual		

¹ From low battery warning to power off is about 5hours

Standard Accessories

Name	Model	Specification	Applicable DMM Models			
			TY700		TY500	
			TY710	TY720	TY520	TY530
Test leads	98073	1000V CAT III 600V CAT IV Red/Black(1set)	●	●	●	●
Fuse	99015	440 mA/1000 V	●	●	●	●
	99016	10 A/1000 V	●	●	●	●

Accessories

Name	Model	Specification	Applicable DMM Models			
			TY700		TY500	
			TY710	TY720	TY520	TY530
Communication Package for Digital Multimeters	92015	Communication Adapter for USB+cable+Application Software	●	●		●
Test leads with Alligator Clip	99014	1000V CAT III 600V CAT IV Red/Black(1 set)	●	●	●	●
Alligator Clips	B9646HF	Red/Black(1 set)	●	●	●	●
Carrying Case	93029	Hard case	●	●	●	●
	B9646GB	Hard case	●	●	●	●
Temperature Probe (Thermocouple type K) (Banana plug output)	90050B	-50 to 600°C for liquid	●	●	●	●
	90051B	-50 to 600°C for liquid	●	●	●	●
	90055B	-20 to 250°C for surface	●	●	●	●
	90056B	-20 to 500°C for surface	●	●	●	●
Currents Clamp-on probe	96001	For 400 AAC Output: AC10 mV/A ^{*1}	●	●	●	●
	96095	For 130 AAC/180 ADC Output: AC10 mV/A or DC10 mV/A ^{*2}	●	●	●	●

^{*1} Please use it with the ACV range. It is necessary to read the indicated value in a different way as TY710 and the TY720. The example: In AC1V display = 100 A TY520 and TY530, it is possible to scale it. (Even 60 A or less display is possible in case of 96001.)

^{*2} Please use it with ACV or DCV range. It is necessary to read the indicated value in a different way as TY710 and the TY720. The example: In AC1V display = 100 A TY520 and TY530, it is possible to scale it. (Even 60 A or less display is possible in case of 96095.)

Model	Diameter of measurable conductor	Range	Accuracy	AC current	DC current	Leak current	DC voltage	AC voltage	Resistance	Continuity check	Frequency	True RMS	Output	Data hold	Peak hold	Filter
CL120	φ 24	20 to 200 A	2.0 + 7	●												
CL150	φ 54	400 to 2000 A	1.0 + 3	●			●	●	●	●			●	●	●	
CL155	φ 54	400 to 2000 A	1.0 + 3	●			●	●	●	●		●	●	●	●	
CL220	φ 24	40 to 300 A	1.0 + 4	●	●										●	
CL235	φ 33	400 to 600 A	1.0 + 5	●	●		●	●	●	●	●	●			●	
CL250	φ 55	400 to 2000 A	1.5 + 2	●	●		●	●	●	●			●	●		
CL255	φ 55	400 to 2000 A	1.5 + 2	●	●		●	●	●	●		●	●	●	●	
CL320	φ 24	20 mA to 200 A	2.0 + 4	●		●									●	●
CL340	φ 40	40 mA to 400 A	1.0 + 5	●		●									●	●
CL345	φ 40	40 mA to 400 A	1.0 + 5	●		●						●			●	●
30031A	φ 40	3 mA to 60 A	1.0 + 5	●		●									●	
30032A	φ 40	3 mA to 60 A	1.0 + 5	●		●									●	●
CL360	φ 68	200 mA to 1000 A	1.0 + 2	●		●							●	●	●	●
CL420	φ 6	DC 20 to 100 mA	0.2 + 3		●								●	●		

Clamp-on Tester **CL120**

Light Weight & Compact Design



- ACA
- φ 24
- AC/20 to 200 A

Specifications

Accuracy: (23°C ±5°C, Less than 75% RH), ±(% rdg + dgt)

Item	Range	Accuracy
ACA	20 A	2.0 + 7 (50 to 1 kHz)
	200 A	2.0 + 5 (50/60 Hz)
		3.0 + 10 (40 to 1 kHz)

Clamp-on Testers **CL150/CL155**

Wide Range of Current Measurement



- ACA
- φ 54
- AC/400 to 2000 A
- AC V/DC V/Ω
- DC Output
- RMS for CL155

Specifications

Accuracy: (23°C ±5°C, Less than 75% RH), ±(% rdg + dgt)

Item	Range	Accuracy
ACA	20 A	1.0 + 3 (50/60 Hz)
	400 A	2.0 + 3 (40 to 1 kHz)
	2000 A (0 to 1500 A)	1.0 + 3 (50/60 Hz)
		3.0 + 3 (40 to 1 kHz)
	2000 A (1500 to 2000 A)	3.0 (50/60 Hz)
ACV	40/400/750 V	1.0 + 2 (50/60 Hz) 1.5 + 3 (40 to 1 kHz)
DCV	40/400/1000 V	1.0 + 2
Resistance	400/4 k/40 k/400 kΩ	1.5 + 2, Beep sound at less than 50 ±35 Ω

Clamp-on Tester **CL220**

AC/DC Current Measurement



- ACA/DCA
- φ 24
- AC/40 to 300 A
- DC/40 to 300 A

Specifications

Accuracy: (23°C ±5°C, Less than 85% RH), ±(% rdg + dgt)

Item	Range	Accuracy
ACA	40 A	1.0 + 4
	300 A (20 to 200 A)	1.5 + 4
	300 A (200 to 300 A)	3.0
DCA	40 A	1.0 + 4 (50/60 Hz) 2.5 + 4 (20 to 1 kHz)
	300 A (20 to 200 A)	1.5 + 4 (50/60 Hz)
		2.5 + 4 (20 to 1 kHz)
	300 A (200 to 300 A)	3.5 (50/60 Hz)
		4.0 (20 to 1 kHz)

Clamp-on Tester **CL235**

RMS ACA/DCA Measurement



- ACA/DCA
- φ 33
- AC/400 to 600 A, DC/400 to 1000 A
- AC V/DC V/Ω/Hz
- RMS

Specifications

Accuracy: (23°C ±5°C, Less than 75% RH), ±(% rdg + dgt)

Item	Range	Accuracy
ACA	400/600 A	1.5 + 5 (50/60 Hz)
		3.5 + 5 (40 to 1 kHz)
DCA	400/1000 A	1.0 + 5
ACV	40/400/600 V	1.5 + 5 (50/60 Hz)
		3.5 + 5 (40 to 1 kHz)
DCV	40/400/600 V	1.0 + 5
Resistance	400/4000 Ω	1.0 + 5, Beeps at below 20 Ω (continuity check)
Frequency	10 to 3000 Hz	1.5 + 5

Leakage Clamp-on Tester CL320

Compact Design of Leakage Current Measurement



- ACA
- ϕ 24
- AC/20 mA to 200 A



Specifications Accuracy: (23°C ±5°C, Less than 85% RH), ±(% rdg + dgt)

Item	Range	Accuracy	
		WIDE (40 to 400 Hz)	50/60 Hz
ACA	20 mA/200 mA	2.0 + 4 (50/60 Hz)	3.0 + 5 (50/60 Hz)
	200 A (0 to 100 A)	5.0 + 6 (40 to 400 Hz)	
	200 A (100.1 to 200 A)	5.0 + 4 (50/60 Hz)	5.0 + 5 (50/60 Hz)

Leakage Clamp-on Tester CL360

Wide Range of Leakage Current Measurement



- ACA
- ϕ 68
- AC/200 mA to 1000 A
- DC/AC Output



Specifications Accuracy: (23°C ±5°C, Less than 85% RH), ±(% rdg + dgt)

Item	Range	Accuracy	
		WIDE (40 to 1 kHz)	50/60 Hz
ACA	20 mA/2 A/20 A	1.0 + 2 (50/60 Hz) 3.0 + 2 (40 to 1 kHz)	1.5 + 2
	200 A	1.5 + 2 (50/60 Hz) 3.5 + 2 (40 to 1 kHz)	2.0 + 2
ACA	1000 A (0 to 500 A)	1.5 + 2 (50/60 Hz) 3.5 + 2 (40 to 1 kHz)	2.0 + 2
	1000 A (501 to 1000 A)	5.0 (50/60 Hz) 10.0 (40 to 1 kHz)	5.5

Clamp-on Process Meter CL420

DC Signals of 4 to 20 mA Measurement



- DCmA
- ϕ 6
- DC/20 mA to 100 mA
- DC Output



Specifications Accuracy: (23°C ±5°C, Less than 80% RH), ±(% rdg + dgt)

Item	Range	Accuracy
DCmA	20 mA	0.2 + 5
	100 mA	1.0 + 5

Clamp-on Testers CL250/CL255

Wide Range of ACA/DCA Measurement



- ACA/DCA
- ϕ 55
- AC/400 to 2000 A, DC/400 to 2000 A
- AC V/DC V/ Ω
- DC Output
- Hz, RMS for CL255



CL250 Specifications Accuracy: (23°C ±5°C, Less than 75% RH), ±(% rdg + dgt)

Item	Range	Accuracy
DCA	400/2000 A	1.5 + 2
		1.5 + 2 (50/60 Hz)
ACA	400 A/2000 A (0 to 1000 A)	3.0 + 4 (40 to 500 Hz)
		5.0 + 4 (500 to 1 kHz)
	2000 A (1001 to 2000 A)	3.0 + 2 (50/60 Hz)

CL255 Specifications Accuracy: (23°C ±5°C, Less than 75% RH), ±(% rdg + dgt)

Item	Range	Accuracy
DCA	400/2000 A	1.5 + 2
		1.5 + 3 (50/60 Hz)
ACA	400 A/2000 A (150 to 1700 A)	3.0 + 4 (30 to 1 kHz)
		3.5 + 3 (50/60 Hz)
	2000 A (1701 to 2000 A)	3.5 + 3 (50/60 Hz)

Leakage Clamp-on Testers CL340/CL345

Leakage Current Measurement



- ACA
- ϕ 40
- AC/40 mA to 400 A
- RMS for CL345



CL340 Specifications Accuracy: (23°C ±5°C, Less than 85% RH), ±(% rdg + dgt)

Item	Range	Accuracy	
		WIDE (20 Hz)	50/60 Hz
ACA	40 mA/400 mA	2.5 + 10 (20 to 1 kHz)	1.0 + 5 (50/60 Hz)
	400 A (0 to 350 A)	2.5 + 10 (40 to 1 kHz)	1.0 + 5 (50/60 Hz)
	400 A (350 to 400 A)	5.0 (40 to 1 kHz)	2.0 (50/60 Hz)

CL345 Specifications Accuracy: (23°C ±5°C, Less than 85% RH), ±(% rdg + dgt)

Item	Range	Accuracy	
		WIDE (20 Hz)	50/60 Hz
ACA	40 mA/400 mA	2.5 + 10 (20 to 1 kHz)	1.0 + 5 (50/60 Hz)
	400 A (0 to 300 A)	2.5 + 10 (40 to 1 kHz)	1.0 + 5 (50/60 Hz)
	400 A (300 to 400 A)	5.0 (40 to 1 kHz)	2.0 (50/60 Hz)

Leakage Clamp-on Tester 30031A/30032A

Leakage Currents of 1 mA Measurement



- ACA
- ϕ 40
- AC/3 mA to 60 A



Specifications Accuracy: (23°C ±5°C, Less than 80% RH), ±(% rdg + dgt)

Item	Range	Accuracy	
		30031 A, 30032 A Filter OFF	30032 A Filter ON
ACA	0 to 30 mA	1.0 + 5 (50±1.0 Hz/60±1.0 Hz)	1.5 + 5 (50±1.0 Hz/60±1.0 Hz)
	0 to 50 A		
	50 to 60 A	5.0 + 5 (50±1.0 Hz/60±1.0 Hz)	5.5 + 5 (50±1.0 Hz/60±1.0 Hz)

Digital Insulation Tester **MY600**

Improve The Inspection Efficiency by High-speed Measurement and 6 ranges



Features

- 6 Ranges
- Approximately 0.5 s high-speed measurement*
- Two colors for judging measurement results
- USB communication and memory function
- Line probe with switch is provided as a standard accessory
- Insulation deterioration diagnosis (PI and DAR measurement*)

*Under the conditions specified by Yokogawa, it may take time to measure due to the influence of capacitive component of a measuring target.

General Specifications

- Dimensions: Approx. 156 (W) × 46 (H) × 97 (D) mm
- Weight: Approx. 490 g (with battery)
- Power source: Four size AA batteries

Main Specifications Accuracy (tolerance): Within 1 year of shipment

Rated Measuring Voltage	50 V	100 V*	125 V*	250 V	500 V	1000 V
Maximum Effective Reading	100 MΩ	200 MΩ	250 MΩ	500 MΩ	2000 MΩ	4000 MΩ
First Effective Measurement Range Accuracy	0.100 to 10.00 MΩ	0.100 to 20.00 MΩ	0.100 to 25.00 MΩ	0.100 to 50.0 MΩ	0.100 to 500 MΩ	0.100 to 1000 MΩ
	±2% reading ±2 digit					
Second Effective Measurement Range Accuracy	10.01 to 100.0 MΩ	20.01 to 200.0 MΩ	25.01 to 250.0 MΩ	50.1 to 500 MΩ	501 to 2000 MΩ	1001 to 4000 MΩ
	±5% reading					
	0.050 to 0.099 MΩ: ±2% reading ±4 digit					
Other Ranges Accuracy	0.000 to 0.049 MΩ: ±2% reading ±6 digit					

*Switching method

Other Features

Voltage Measurement	AC	2.0 to 600 Vrms (45 to 65 Hz)
	DC	±(2.0 to 600) V
	Accuracy	±1% reading ±4 digit AC/DC auto detection (2 V or more)
Low resistance Measurement	Range	40.00/400.0/4000 Ω (Auto range)
	Accuracy	±2.5% reading ±8 digit (0.20 to 4000 Ω) ±8 digit (0.00 to 0.19 Ω)
Display	Bar graph, 4000 digital count display	
Measurement Categories	CAT III 600 V	
Standard	EN61557-1, 2, 4, 10 EN61326-1 ClassB, EN61326-2-2 EN61010-1, EN61010-031, EN61010-2-30, IEC61010-2-034	

Quick-reference Table of Accessories

	Model	MY600
Spare Probe Tip	Extended	99013
	Hook type	99012
Probe	Line probe	98008
	Earth probe	98009 Earth probe and Alligator clip adaptors
Case ¹	Carrying case	93045 (Soft case) Store main unit and accessories
Others	Shoulder strap	99018
	USB communication adaptor	91030

¹ Regarding external dimensions of cases, Please refer to each product specification.

Spare Probe Tips

Unit: mm

99013

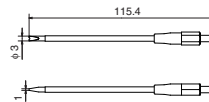

99012

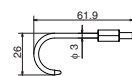

Probes

Unit: mm

98008

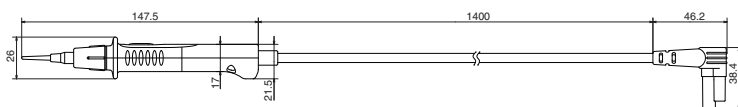

98009

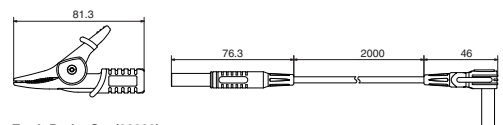

Earth Probe Set (98009)

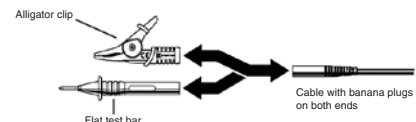

Digital Earth Tester **EY200**

Earth Tester Capable to Measure by 3 Pole or 2 Pole Method



Features

- Capable to measure by 3-pole or 2-pole measuring
- Easy to measure with one touch button and dedicated test lead
- Small and lightweight
- Dust and drip proof (designed to IEC60529 IP54)

Specifications

Display	LCD Digital Display: 1999-count digital reading
Measuring Range	Earth Resistance: 2000 Ω LSD: 0.01 to 1 Ω Earth Voltage: 200 V
Accuracy	Earth Resistance: 20 Ω range: $\pm 2\% \text{rdg} \pm 0.1 \Omega$ 200 Ω range: $\pm 2\% \text{rdg} \pm 3 \text{dgt}$ 2000 Ω range: $\pm 2\% \text{rdg} \pm 3 \text{dgt}$
Measuring Frequency	Earth Voltage: $\pm 1\% \text{rdg} \pm 4 \text{dgt}$
Measuring Current	Approx. 820 Hz
Battery	Approx. 3 mA (at 20 Ω range)
Battery Life	Six AA (R6) drycells
Operating Temp. and Humidity	Approx. 4.5 hours (at 5 second measuring 3300 times)
Dimensions	0 to 40°C, 85%Rh or less
Weight	0 to 40°C, 85%Rh or less
	Approx. 105 \times 158 \times 70 mm
	Approx. 550 g

Digital Thermometers **TX10 Series**

Simplified Thermometer with easy operation



- TX1001: 1-channel Single-function with data hold function
- TX1002: 1-channel Multifunction with data hold, internal memory, user-calibration and relative display function
- TX1003: 2-channel Multifunction with data hold, internal memory, user-calibration and relative display function

TX10 Series Specifications

- Thermocouple measurement ranges
 - Type K: -200 to 1372°C
 - Type J: -200 to 1000°C
 - Type E: -200 to 700°C
 - Type T: -200 to 400°C
- Resolution
 - 200.0 to 199.9°C: 0.1°C, 200°C: 1°C (TX1001)
 - 200.0 to 199.9°C: 0.1°C or 1°C (when resolution is set at 1°C), 200°C: 1°C (TX1002, 03)
- Accuracy
 - 200.0 to -100.1°C: $\pm(0.1\% \text{ of rdg} + 1.0^\circ\text{C})$;
 - 100.0 to 199.9°C: $\pm(0.1\% \text{ of rdg} + 0.7^\circ\text{C})$;
 - 200°C and when resolution is set at 1°C: $\pm(0.2\% \text{ of rdg} + 1^\circ\text{C})$
- General Specifications
 - External dimensions: 56 (W) × 151 (H) × 33 (D) mm
 - Weight: Approx. 180 g
 - Power: Two AA size (LR6) dry batteries

Specifications

Model	Description (Type)	Measurement Range	Sheath Diameter	Sheath Length	Tolerance
90020B	Rounded end	-50 to 600°C	3.2 mm dia.	200 mm	$T < 375^\circ\text{C}: \pm 1.5^\circ\text{C}$ $375^\circ\text{C} \leq T: \pm 0.004 \times T^\circ\text{C}$
90021B	Rounded end	-50 to 600°C	1.6 mm dia.	150 mm	
90022B	Rounded end	-50 to 600°C	3.2 mm dia.	500 mm	
90023B	Needle	-50 to 500°C	1.6 mm dia.	100 mm	
90024B	Needle	-50 to 500°C	2.1 mm dia.	100 mm	
90030B	Surface straight	-20 to 250°C	Diameter of thermosensitive part 15 mm dia.		$(T-T_s) \leq 100^\circ\text{C}: \pm 2.5^\circ\text{C}$, $100^\circ\text{C} < (T-T_s): -0.03 \times T \text{ to } +2.5^\circ\text{C}$, $T: -20^\circ\text{C} \text{ to } 250^\circ\text{C}$, $T_s: 0^\circ\text{C} \text{ to } 40^\circ\text{C}$ $(T-T_s) < 333^\circ\text{C}: +2.5^\circ\text{C}$, $333^\circ\text{C} \leq (T-T_s): +0.0075 \times T^\circ\text{C}$, $(T-T_s) < 167^\circ\text{C}: -2.5^\circ\text{C}$, $167^\circ\text{C} \leq (T-T_s): -0.015 \times T^\circ\text{C}$, $T: -20^\circ\text{C} \text{ to } 500^\circ\text{C}$, $T_s: 0^\circ\text{C} \text{ to } 40^\circ\text{C}$
90031B	Surface angled	-20 to 250°C			
90032B	Surface straight	-20 to 500°C			
90033B	Surface angled	-20 to 500°C			
Model	Probe type	Measurement Range	Accuracy	Sensor Diameter/Length (m/m)	
90029B	Bead TC	-40 to 260°C	$\pm 2.5^\circ\text{C}$	1200 (included cord)	

Thermocouple type: K

T: measurement temperature, Ts: ambient temperature

Dimensions

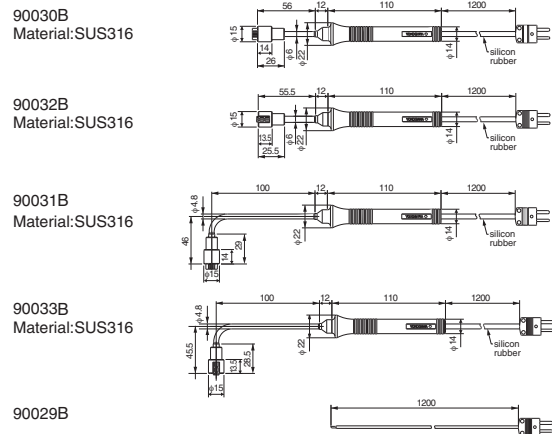
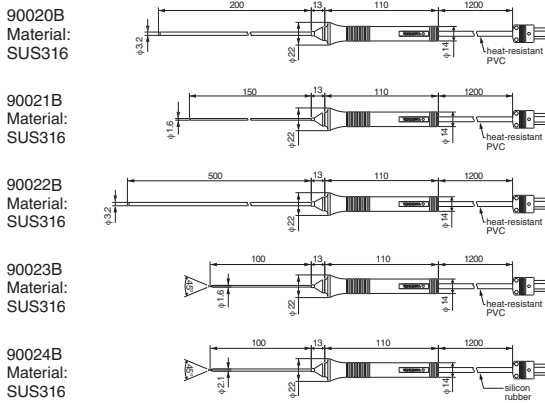

Standard Resistors **2792A Series**

Metal foil resistors



- Traced to the national standard for high accuracy; test (calibrated) accuracy of ± 5 ppm
- Resistance temperature coefficient
- A variety of models
Eight models with nominal resistance values ranging between 0.001 Ω and 10 k Ω
- Precision temperature control equipment, such as an oil bath, not needed for calibration due to marked improvement in resistance temperature coefficient
- Included document: Test certificate

Specifications

Model	Nominal value	Accuracy 23°C \pm 2°C
2792A01	0.001 Ω	± 100 ppm
2792A02	0.01 Ω	± 75 ppm
2792A03	0.1 Ω	± 50 ppm
2792A04	1 Ω	± 30 ppm
2792A05	10 Ω	± 30 ppm
2792A06	100 Ω	± 30 ppm
2792A07	1 k Ω	± 30 ppm
2792A08	10 k Ω	± 30 ppm

Operating temperature and humidity ranges:
0 to 50°C / 20 to 80% RH
Maximum allowable power: 3 W
Test (calibrated) accuracy: ± 5 ppm
Power characteristics: ± 100 ppm/W
Insulation resistance:
More than 1000 M Ω at 500 V DC
Withstand voltage: 1.5 kV for one minute between measurement terminal and casing
Terminal construction: 4 terminals
External dimensions: Approximately ϕ 104 \times 150 mm (current terminal width: approximately 174 mm)
Weight: Approximately 1.2 kg
Accessories: User'S Manual, One Test Certificate

Decade Resistance Boxes **278610/278620**

Quick and easy setting



Models 278610 and 278620 six-dial decade resistance boxes allow quick and easy setting of a wide range of resistance. These resistance boxes are used in combination with voltage or current standards to adjust voltage or current, as dummy load resistances or as an arm of AC bridges.

Specifications

Available Models:

Model Number	Resistance Range
278610	0.1 to 111,111 Ω (six decade dials)
278620	1 to 1,111,110 Ω (six decade dials)

Residual Resistance: Less than 23 m Ω .
Power Rating: 0.3 W/step, within 3 W for overall instrument.
Maximum Allowable Input: 0.5 W/step, 5 W for overall instrument.
Maximum Circuit Voltage: 250 V.
Operating Temperature Range: 0 to 40°C
Storage Temperature Range: -10 to 50°C
Humidity Range: 25 to 85%, relative humidity.
Insulation Resistance: More than 500 M Ω at 500 V DC.
Dielectric Strength: 1500 V AC for one minute.
Dimensions: Approx. 497 (W) \times 116 (H) \times 140 (D) mm
Weight: Approx. 3.5 kg

Decade Resistance Boxes **279301/279303**

High-accuracy, DC variable resistor with 6 dials



279301

- High accuracy and stability
- High reproducibility
- 1 m Ω resolution

279303

- Up to 100 M Ω in 100 Ω step
- Low voltage coefficient
- Shock- and vibration-proof construction

279301 Specifications

Resistance Range: 0.100 to 1,111.210 Ω (Minimum resistance is 0.100 Ω).
Dial Composition: 0.001 \times 10 + 0.01 \times 10 + 0.1 \times 11 + 1 \times 10 + 10 \times 10 + 100 \times 10
Resolution: 0.001 Ω
Accuracy: \pm (0.01% + 2 m Ω) at temperature 23 \pm 2°C, humidity 45 to 75%, and 0.1 W power application
Dimensions: Approx. 497 (W) \times 116 (H) \times 140 (D) mm
Weight: Approx. 4.8 kg

279303 Specifications

Resistance Range: 0 to 111.1110 M Ω .
Dial Composition: 100 Ω \times 10 + 1 k Ω \times 10 + 10 k Ω \times 10 + 100 k Ω \times 10 + 1 M Ω \times 10 + 10 M Ω \times 10.
Accuracy: 100 Ω , 1 k Ω , 10 k Ω and 100 k Ω steps ... \pm (0.05% + 0.05 Ω)
1 M Ω and 10 M Ω steps ... \pm 0.2%
(At temperature 23 \pm 2°C, humidity below 75%, including residual resistance of approx. 0.05 Ω).
Dimensions: Approx. 497(W) \times 116(H) \times 140(D) mm
Weight: Approx. 4.8 kg

SMARTDAC+ Paperless Recorder GP Series, Data Acquisition System GM

A Next-generation Data Acquisition and Control System with Excellent Operability and Expandability

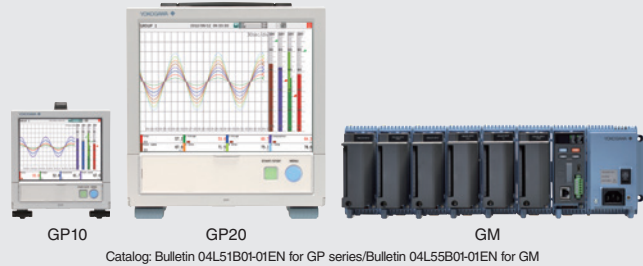

Catalog: Bulletin 04L51B01-01EN for GP series/Bulletin 04L55B01-01EN for GM

Smart user interface for intuitive operation (GP series)

Review historical data easily

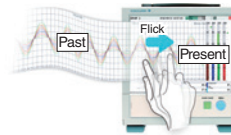

Zoom in/out horizontally and vertically

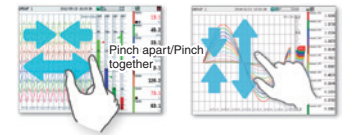

Monitoring and setting on a tablet (GM10)

Supports Bluetooth (option code/C8). There is no need to bring a PC to the site; you can use a tablet for setting and monitoring.



Dual interval measurement with two different scan intervals

Provides for efficient, simultaneous measurement of signals with slow fluctuations such as temperature, and fast-changing signals such as pressure and vibration, with two different scan intervals in a single system.



Multi-unit configuration by connecting expansion units

Supports measurements at up to 450 ch (GP20) and 420 ch (GM10)

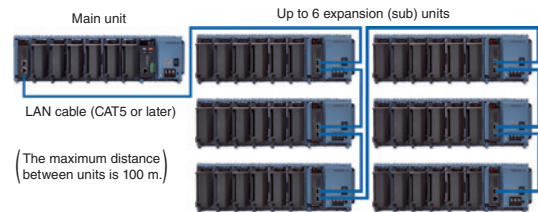

Acquire data from power measuring instruments

The GP recorder and the GM system can acquire data from power measuring instruments (WT series power analyzers) without loss of fidelity and record and display with their own data (option codes /E2 and /MC).

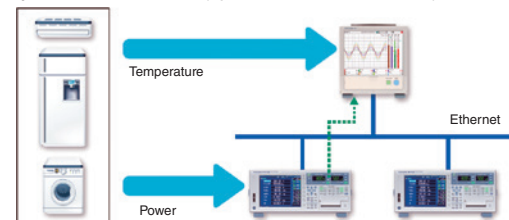

Specifications

Model	GP10	GP20-1	GP20-2	GM10-1	GM10-2
Mounting	Desktop			Desktop, DIN rail, vertical panel mount (screws)	
Display (TFT color LCD)	5.7" (640 × 480 dots)	12.1" (800 × 600 dots)			
Touch screen	4-wire resistive touch screen, 2-point touch detection				
No. of connectable modules	3	10		10 (Up to 8 when GX90XA-10-T1 or -04-H0 is mounted)	
Max. (with expansion units)	10	10	45	10	42
Max. no. of I/O channels	100	100	500	100	500
No. of connectable WT communication units (/E2*)	8	16	16	16	16
No. of communication channels (/MC*)	50	300	500	300	500
No. of channels allocatable to WT (/E2*)	50	300	300	300	300
No. of mathematical channels (MT*)	50	100	200	100	200
No. of recording channels	500	500	1000	500	1000
Internal memory (flash)	500 MB	500 MB	1.2 GB	500 MB	1.2 GB
Communication interface	Ethernet, RS-232 (/C2*), RS-422/485 (/C3*), USB host (/UH*)			Ethernet, USB, RS-422/485 (/C3*), Bluetooth (/C8*)	
Rated supply voltage	AC model	100 to 240 VAC		100 to 240 VAC	
	DC model	12 VDC		12 to 28 VDC	
Dimensions (W × H × D) with modules mounted	144 × 168 × 248 (mm)	288 × 318 × 248 (mm)		Max. 638 × 137.7 × 146 (mm)	
Ambient temperature	0 to 50°C			-20 to 60°C (-20 to 50°C for some configurations)	

Measurement interval: Normal mode: 100/200/500 ms, 1/2/5 s
High speed or Dual interval mode: 1/2/5/10/20/50/100/200/500 ms, 1/2/5 s (Available intervals depend on scan configurations and modules.)

External storage media: 1 to 32 GB SD/SDHC memory card (a 1 GB card is included)
Format: FAT32 or FAT16

Data format: Normal mode: Binary or text; High speed or Dual interval mode: Binary
Ethernet: 10Base-T/100Base-TX (E-mail, FTP, Web, SNMP, etc.)
WT communication (/E2*): Supported models: WT1800, WT500, WT300
Supported communication: Ethernet
Communication interval: 500 ms, 1/2/5/10/20/30 s

USB host for GP (/UH*): Complies with USB 2.0 (USB memory; keyboard or mouse complying with HID Class Ver. 1.1)

USB communication for GM: Complies with USB 2.0 (recognized as a serial port by a PC)

Bluetooth for GM (/C8*): Bluetooth® Ver 2.1+EDR compliant, SPP (serial port profile), Class 2 (communication range: approx. 10 m depending on the usage environment)

*: Option code

Expansion (sub) unit specifications	GX60	GM configuration
Construction	Desktop, vertical panel mount (screws)	Desktop, DIN rail, vertical panel mount (screws)
No. of connectable modules	6	6
Rated supply voltage	AC model	100 to 240 VAC
	DC model	12 to 28 VDC
Dimensions (W × H × D) with modules mounted	412.5 × 164.7 × 147 (mm)	Max. 438 × 137.7 × 146 (mm)
Ambient temperature	0 to 50°C	-20 to 60°C (-20 to 50°C for some configurations)

I/O Modules and GX90EX (I/O expansion module)

Model	Suffix code	Name	Specification/Application	Shortest cycle
GX90XA	-10-U2N-□	Analog input module	10 ch, DCV/TC/RTD/DI, SSR scanner type (RTD b-terminal common)	100 ms
	-10-V1N-□		10 ch, high withstand voltage, DCV/TC/DI, SSR scanner type (isolated between channels)	100 ms
	-10-L1N-□		10 ch, low withstand voltage, DCV/TC/DI, SSR scanner type (isolated between channels)	500 ms
	-10-T1N-□		10 ch, DCV/TC/DI, electromagnetic relay scanner type (isolated between channels)	1 s
	-10-C1N-□		10 ch, current (mA), SSR scanner type (isolated between channels)	100 ms
	-04-H0N-□		4 ch, DCV/TC/RTD/DI, individual A/D type (isolated between channels)	1 ms
	-06-R1N-□		6 ch, 4-wire RTD/resistance, SSR scanner type (isolated between channels)	100 ms
GX90YA	-04-C1N-□	Analog output module	4 ch, current (mA), (isolated between channels)	100 ms
GX90XD	-16-11N-□	Digital input module	16 ch (shared common)	100 ms
GX90YD	-06-11N-3N	Digital output module	6 ch	100 ms
GX90WD	-0806-01N-3N	Digital I/O module	Input 8 ch (shared common), output 6 ch	100 ms
GX90XP	-10-11N-□	Pulse input module	10 ch (shared common)	100 ms
GX90UT	-02-11N-3N	PID control module	PID control (2 loops)	100 ms
GX90EX	-02-TP1N-N	I/O expansion module	Each of GP main body, GM main unit, and expansion (sub) unit can mount one GX90EX. (One GX90EX is provided with a GX60.)	

The "□" in the suffix code represents the terminal form (-3: M3 screw terminal, -C: Clamp terminal)
Up to 10 modules consisting of GX90YD, GX90WD, and GX90UT can be mounted in a system. Each of the GP main body, GM main unit, and expansion (sub) unit can mount one GX90WD.
The /MT option (MATH) is required for GX/GP/GM main unit to perform pulse measurement/integration on GX90XD/GX90WD, or pulse integration on GX90XP.
For other limitations, please refer to product brochure or general specifications.

Models, Suffix Codes, and Configurations

Please contact us for the prices.

Model	Suffix Code	Description
GP10		Paperless recorder (portable type with a small display)
GP20		Paperless recorder (portable type with a large display)
Type	-1	Standard (max. measurement channels: 100)
	-2	Large memory (max. measurement channels: 500) (GP20 only)
Display Language	E	English, degF, DST (summer/winter time)
Power Supply	1	100 VAC, 240 VAC
	2	12 VDC (GP10 only)
Power Cord	D	Power cord UL/CSA standard
	F	Power cord VDE standard
	R	Power cord AS standard
	Q	Power cord BS standard
	H	Power cord GB standard
	N	Power cord NBR standard
	W	Screw terminal, power cord not included
Optional Features	/AH	Aerospace heat treatment
	/AS	Advanced security function (Part 11)
	/BT	Multi-batch function
	/C2	RS-232
	/C3	RS-422/485
	/CG	Custom display
	/D5	VGA output (only for GP20)
	/E1	EtherNet/IP communication (PLC communication protocol)
	/E2	WT communication
	/E3	OPC-UA server
	/E4	SLMP communication (Mitsubishi PLC)
	/FL	Fail output (1 point)
	/LG	Log scale
	/MC	Communication channel function
	/MT	Mathematical function (with report function)
	/PG	Program control function
	/UH	USB interface (2 host ports)

Recorders can be shipped with specified I/O modules mounted (optional).

GP main body configuration

Main body alone:
Up to 3 I/O modules
With expansion units:
Up to 2 I/O modules + GX90EX

GM main unit configuration

Main unit alone
GM10 + GM90MB + GM90PS
I/O module + GM90MB (Max. 10 modules)

With sub units
GM10 + GM90MB + GM90PS
GM90EX + GM90MB + I/O module + GM90MB (Max. 6 modules)

Model	Suffix Code	Description
GM10		Data Acquisition Module for SMARTDAC+ GM
Type	-1	Standard (Max. measurement channels: 100)
	-2	Large memory (Max. measurement channels: 500)
Area	E	General (temp. unit: Cel, degF)
Optional Features	0	Always 0
	/AH	Aerospace heat treatment
	/AS	Advanced security function (Part 11)
	/BT	Multi-batch function
	/C3	RS-422/485
	/C8	Bluetooth
	/E1	EtherNet/IP communication (PLC communication protocol)
	/E2	WT communication
	/E3	OPC-UA server
	/E4	SLMP communication (Mitsubishi PLC)
	/LG	Log scale
	/MC	Communication channel function
	/MT	Mathematical function (with report function)
	/PG	Program control function

Model	Suffix Code	Description
GM90PS		Power Supply Module for SMARTDAC+ GM
Type	-1	Always -1
Region	N	General
Supply Voltage	1	100 to 240 VAC
	2	12 to 28 VDC
Power Supply Connection	D	Power inlet with UL/CSA cable
	F	Power inlet with VDE cable
	H	Power inlet with GB cable
	N	Power inlet with NBR cable
	Q	Power inlet with BS cable
	R	Power inlet with AS cable
	W	Screw terminal (without power cable)
	0	Always 0

Model	Suffix Code	Description
GM90MB	-01N0	Module Base for SMARTDAC+ GM
Model		
GM60		I/O base unit
Type	-EX	I/O expansion
Area	N	General
Power Supply	1	100 VAC, 240 VAC
Power Cord	D	Power cord UL/CSA standard
	F	Power cord VDE standard
	R	Power cord AS standard
	Q	Power cord BS standard
	H	Power cord GB standard
	N	Power cord NBR standard
	W	Screw terminal (power cord not included)

Expansion (sub) unit configuration

Up to 6 I/O modules
GX60

GX90EX + GM90MB + GM90PS
I/O module + GM90MB (Max. 6 modules)

SMARTDAC+ GA10 Data Logging Software

Monitors and records data from power meters, recorders, and data loggers

GA10 is a PC based software package that acquires data from multiple devices – such as power meters (WT series), recorders, and data loggers. Connected PCs can monitor real time and historical data, which can be stored on a PC hard drive.

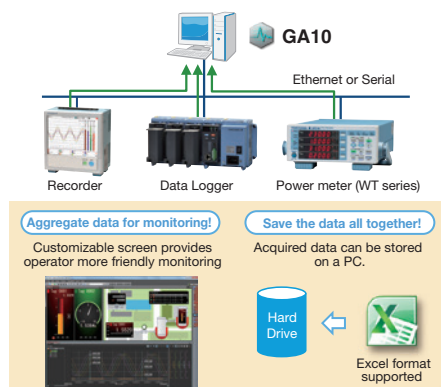

Specifications

- Max. connectable devices: 100
- Max connectable clients: Unlimited (Connection with up to 32 units has been verified.)
- Max. recording tags (channels): Tags: 2000 ch
Mathematical tags (option code/MT): 2000 ch
- Scan interval: 100 ms at shortest (depending on the scan interval of each instrument when using instrument time)

For details, please contact Yokogawa Electric Corporation:
Phone: (81)-422-52-7179 / E-mail: ns@cs.jp.yokogawa.com

Multi-logging

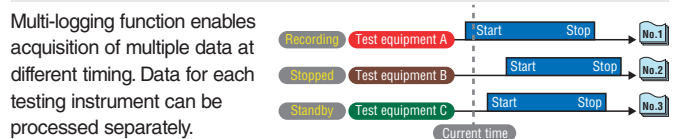

Reporting/printing

Reports can be printed automatically. The layout can be customized. The insertion of waveforms and images, and the creation of spreadsheets in PDF or Excel format are supported (suffix code /RP).

Models, Suffix Codes, and Configurations

Please contact us for the prices.

Data logging software

Model	Suffix Code	Description
GA10		Data Logging Software License
Number of Channels	-01	100 ch
	-02	200 ch
	-05	500 ch
	-10	1000 ch
	-20	2000 ch
Optional Features	/RP	Reporting/printing function
	/MT	Math function
	/UA	OPC-UA server function
	/CG	Custom display function
	-WH	Integration display function
	-SU	GateSushi function

Additional monitoring PCs (clients)

Model	Suffix Code	Description
GA10CL		Client License for GA10
Number of Licenses	-01	1 license
	-05	5 licenses
	-10	10 licenses
	-50	50 licenses

* Channels can be added.

Worldwide Business Operations

Yokogawa Test & Measurement Global Network



<https://tmi.yokogawa.com/>

The following Web site offer a variety of information and services, such as document download, software download, user registration, e-mail news subscription and other.

Our Web site will help you find what you look for.

The screenshot shows the Yokogawa Test & Measurement website homepage. At the top, there is a navigation bar with the Yokogawa logo, a 'Global' dropdown menu, and links for 'News & Events', 'About Us', and a search icon. Below the navigation bar, there are tabs for 'Industries', 'Products', 'Library', 'Support', and 'Contact Us'. The main content area features a large hero section with the text 'Meet the Precision Makers' and 'The world's most trusted measurement partner'. Below this, there is a 'Spotlights' section with a 'New Product Release' for the DLM5000 8-ch MSO. The DLM5000 section includes an image of the oscilloscope and a description: 'DLM5000 8-ch MSO: More channels, More possibilities, More insight. With an intuitive, easy to use interface, the ability to adapt to your unique testing requirements, and trusted, dependable measurements, the new 8 channel mixed signal oscilloscope DLM5000 speeds up research and development time for your mechatronics, automotive, and power electronics applications.' To the right of the DLM5000 section is a spotlight for the WT5000 Precision Power Analyzer, which was awarded 'Test Product of the Year' at the annual Elektra Awards in London. Below the spotlights is a 'Product Categories' section with eight categories, each represented by an image of a Yokogawa instrument: Oscilloscopes, Power Analyzers, Data Acquisition (DAQ), Optical Test Equipment, Generators, Sources, Portable Ethernet Testers, Portable and Handheld Instruments, and Other Test and Measurement Instruments. At the bottom of the page, there is a horizontal navigation bar with four categories: 'Industries', 'Products', 'Library', and 'Support', each with a corresponding image.

YOKOGAWA Global

News & Events About Us Search

Test&Measurement Industries Products Library Support Contact Us

Meet the Precision Makers

The world's most trusted measurement partner

[Learn More >](#)

Spotlights

New Product Release

DLM5000

DLM5000 8-ch MSO: More channels, More possibilities, More insight

With an intuitive, easy to use interface, the ability to adapt to your unique testing requirements, and trusted, dependable measurements, the new 8 channel mixed signal oscilloscope DLM5000 speeds up research and development time for your mechatronics, automotive, and power electronics applications.

WT5000 Awarded Test Product of the Year

Last week, Yokogawa's WT5000 Precision Power Analyzer was awarded "Test Product of the Year" at the annual Elektra Awards in London. Achieving the world's highest measurement accuracy – $\pm 0.03\%$ of total at 50/60 Hz – the WT5000 has made it possible to evaluate the power consumption, loss, and efficiency of electrical and electronic devices. Read the full story and learn more about this award-winning power analyzer!

Product Categories

- Oscilloscopes
- Power Analyzers
- Data Acquisition (DAQ)
- Optical Test Equipment
- Generators, Sources
- Portable Ethernet Testers
- Portable and Handheld Instruments
- Other Test and Measurement Instruments

Industries Products Library Support



NOTICE

- Before using the product, read the instruction manual carefully to ensure proper and safe operation.

YOKOGAWA TEST & MEASUREMENT CORPORATION *Global Sales Dept.*

4-9-8 Myojin-cho, Hachioji-shi, Tokyo 192-8566, JAPAN
Phone: +81-42-690-8810 E-mail: tm@cs.jp.yokogawa.com Facsimile: +81-42-690-8826

<https://tmi.yokogawa.com/>

YOKOGAWA CORPORATION OF AMERICA

2 Dart Road, Newnan, GA. 30265 U.S.A.
Phone: +1-800-888-6400
E-mail: tmi@us.yokogawa.com

YOKOGAWA EUROPE B.V.

Euroweg 2, 3825 HD Amersfoort,
THE NETHERLANDS
Phone: +31-88-4641429
E-mail: tmi@nl.yokogawa.com

**YOKOGAWA TEST & MEASUREMENT
(SHANGHAI) CO., LTD.**

Room 603, No. 799 West Tianshan Road,
Changning District, Shanghai, CHINA 200335
Phone: +86-21-6239-6363
E-mail: tmi@cs.cn.yokogawa.com
Facsimile: +86-21-6880-4987

**YOKOGAWA ELECTRIC KOREA CO., LTD.
T&M Sales Pangyo Office**

#703, Pangyo Innovalley B, 253, Pangyo-ro,
Bundang-gu, Seongnam-si, Gyeonggi-do,
13486, KOREA
Phone: +82-2-2628-3810
E-mail: TMI@kr.yokogawa.com
Facsimile: +82-2-2628-3899

YOKOGAWA ENGINEERING ASIA PTE. LTD.

5 Bedok South Road, Singapore 469270
SINGAPORE
Phone: +65-6241-9933
E-mail: TMI@sg.yokogawa.com
Facsimile: +65-6241-9919

YOKOGAWA INDIA LTD.

Plot No.96, Electronic City Complex,
Hosur Road, Bangalore - 560 100, INDIA
Phone: +91-80-4158-6396
E-mail: tmi@in.yokogawa.com
Facsimile: +91-80-2852-1442

YOKOGAWA ELECTRIC CIS LTD.

1, Samarskaya street, business center Novion,
Moscow 129110, RUSSIA
Phone: +7-495-737-7868
E-mail: info@ru.yokogawa.com
Facsimile: +7-495-737-7869

YOKOGAWA AMERICA DO SUL LTDA.

Alameda Xingu, 850 – Barueri/SP-06455-030,
BRAZIL
Phone: +55-11-3513-1300
E-mail: eproc@br.yokogawa.com

YOKOGAWA MIDDLE EAST & AFRICA B.S.C(c)

P.O.BOX 10070, Manama, Building 577,
Road 2516, Busaiteen 225, Muharraq, BAHRAIN
Phone: +973-17-358100
E-mail: help.ymatmi@bh.yokogawa.com
Facsimile: +973-17-336100

Represented by:

YMI-KS-MI-ME08